

Schraubstockbefestigung

Vice fastening

179N-75



179N-75

	HAZET No.	
①	179N-75 Schraubstockbefestigung 179N-75 Vice fastening	1

Für Werkstattwagen HAZET *Assistant* 179N/179NX/179NXL und 179NXXL, Bj. → 01.07.2019
 For tool trolleys HAZET *Assistant* 179N/179NX/179NXL and 179NXXL, model year → 01 July 2019

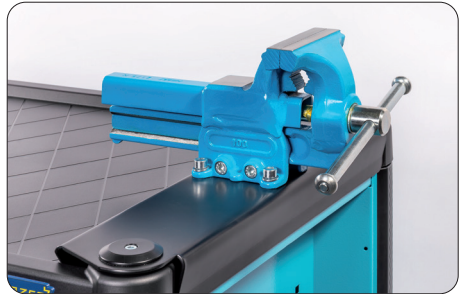
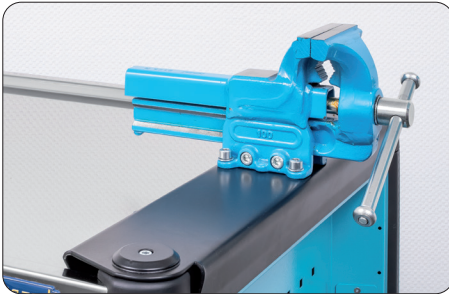

Montage-Schraubstockbefestigung / Installation vice fastening



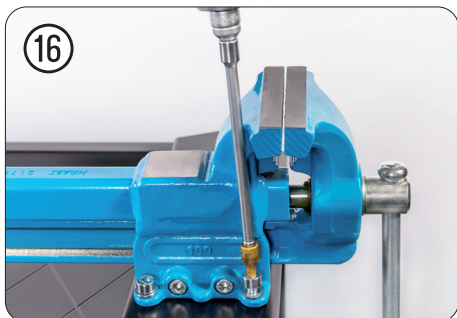

Montage Schraubstock 2175N / Installation vice 2175N

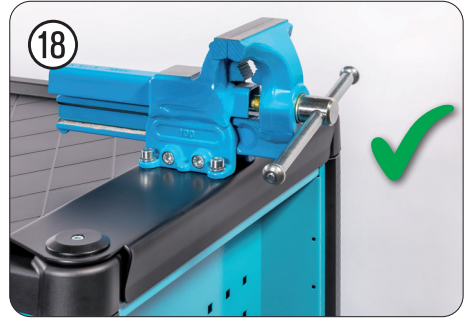

Notizen / Notes

Montage 179W-42/179W-40 / Installation 179W-42/179W-40

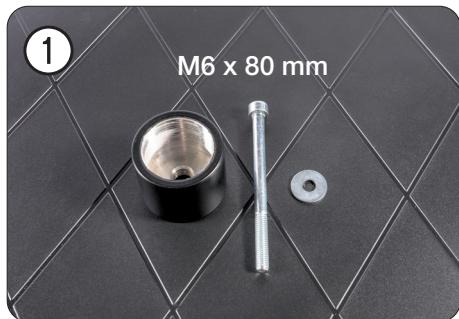





Notizen / Notes

HAZET-WERK Hermann Zerver GmbH & Co. KG

 Güldenwerther Bahnhofstraße 25 - 29 · 42857 Remscheid · GERMANY

 10 04 61 · 42804 Remscheid · GERMANY

 +49 (0) 21 91 / 7 92-0 ·  +49 (0) 21 91 / 7 92-375 ·  www.hazet.de ·  info@hazet.de