



KERN & Sohn GmbH

Ziegelei 1
D-72336 Balingen
E-Mail: info@kern-sohn.com

Phone: +49-[0]7433- 9933-0
Fax: +49-[0]7433-9933-149
Internet: www.kern-sohn.com

Operating instructions Analytical balance

KERN ABP / ABP-A

Version 1.2
2022-06
EN



TABP-BA-e-2212



KERN ABP

Version 1.2 2022-06

Operating instructions Analytical balance

Contents

1	Technical data	5
2	Declaration of conformity	10
3	Appliance overview	11
3.1	Components.....	11
3.2	Keyboard	13
3.2.1	Numeric entry	15
3.3	Display	16
4	Basic Information (General)	19
4.1	Proper use	19
4.2	Improper Use	19
4.3	Warranty	19
4.4	Monitoring of Test Resources.....	20
5	Basic Safety Precautions	20
5.1	Pay attention to the instructions in the Operation Manual	20
5.2	Personnel training	20
6	Transport and storage	20
6.1	Testing upon acceptance	20
6.2	Packaging / return transport	21
7	Unpacking, Installation and Commissioning	23
7.1	Installation Site, Location of Use.....	23
7.2	Unpacking and checking	23
7.3	Placing	26
7.3.1	Installing the glass windshield doors (only ABP-A series)	26
7.3.2	Assembly of the internal windshield	27
7.3.3	Connection of the ionizer.....	27
7.3.4	Installation of weighing plate	28
7.4	Mains connection	31
7.4.1	Turning On the Power	32
7.5	Initial Commissioning	32
7.6	Connection of peripheral devices	33
8	Adjustment	33
8.1	Automatic adjustment via PSC function	34
8.2	Time-controlled automatic adjustment	36
8.3	Manual adjustment via key [CAL-key].....	37
8.3.1	Setting adjustment function for CAL-key	37
8.3.2	Adjustment with internal weight	37
8.3.3	Adjustment test with internal weight	38
8.3.4	Adjustment with external weight.....	38
8.3.5	Adjustment test with external weight	39
8.4	Adjustment log	39
8.5	Regular inspections	40
9	Verification	42
10	Basic Operation	44

10.1	Activate standard weighing mode	44
10.2	Simple weighing	44
10.3	Taring	45
10.4	Functions of the ABP-A series (Standard weighing mode)	46
10.4.1	Measuring with the automatic door function (Position memory function)	46
10.4.2	Measuring with the IR sensor (touchless function)	47
10.5	Adjustable windshield plate (only at ABP-A Half-Micro-Models)	48
10.6	Underfloor weighing.....	49
10.7	Switch off the balance.....	50
10.8	Switch-over weighing unit.....	50
10.9	Change readability (1D/10D) (not available for verified models).....	50
10.10	Display Tare / Net / Gross.....	51
10.11	Display decimal dot as point or comma	52
11	Menu	53
11.1	Navigation in the menu	53
11.1.1	Standard weighing mode	54
11.1.2	Weighing settings	55
11.1.3	System Settings	57
11.1.4	Application settings	59
11.2	Menu overview	59
11.3	Resetting the menu	60
11.4	Menu Lock.....	61
11.5	Log menu settings.....	62
11.6	Menu history	63
12	Description of individual functions	64
12.1	Zero setting and tare function.....	64
12.2	Zero tracking.....	64
12.3	Auto Tare function.....	65
12.4	Settings for Stability and Response.....	66
12.4.1	Stability and reaction settings via „Smart Setting display“ (without invoking menu).....	66
12.5	Dosing.....	67
12.6	Standstill width	68
12.7	Weighing Units	69
12.8	User administration log-in function.....	69
13	Balance settings	76
13.1	Screen saver	76
13.2	Display settings in operating mode.....	77
13.3	Balance identification no.	77
13.4	Entering date and time.....	77
13.5	Date format.....	78
13.6	Brightness of display	78
13.7	Acoustic signal on pressing key and display of stability	79
13.8	User language.....	79
13.9	Configuration of the manual door opener (only ABP-A series).....	79
13.10	Configuration methods of the IR sensors (only ABP-A series)	80
13.10.1	Switch-over the operating mode of the IR sensors	81
14	Application Functions	85
14.1	Piece counting	86
14.1.1	Settings	86
14.1.2	Setting the display	88
14.1.3	Parts counting	88
14.1.4	Change settings	89
14.1.5	Switching between counting and weighing mode	89
14.2	Percent determination.....	90
14.2.1	Settings	90
14.2.2	Setting the display	92
14.2.3	Performing calculation of percentage	93
14.2.4	Change settings	93

14.2.5	Switching between percentage and weighing mode.....	94
14.3	Determining the density of solid matter and fluids	94
14.4	Totalization.....	95
14.5	Recipe composition	98
14.5.1	Free recipe composition.....	98
14.5.2	Define and process recipes.....	101
14.5.3	Change recipe.....	105
14.5.4	Sample log (KERN YKB-01N):.....	106
14.6	Preparing buffer solutions.....	107
14.7	Sample preparation	110
14.7.1	Changing saved samples.....	112
14.8	Statistics.....	113
14.9	Control weighing and target weighing	115
14.9.1	Target weighing.....	115
14.9.2	Control weighing (Pass / Fail evaluation).....	117
14.10	Minimum sample weight.....	119
15	Interfaces.....	120
15.1	Connect printer.....	120
15.2	Connect PC	120
15.3	Connect serial devices / connect programmable controller (SPS / PLC).....	121
15.4	Interface cable (RS232).....	121
15.5	Data transmission format	122
15.6	Interface commands.....	123
15.7	Communication parameters	128
15.7.1	Select standard setting.....	128
15.7.2	User defined settings (display example for KERN YKB-01N.....	129
15.8	Issue functions	131
15.8.1	Automatic data output / Auto Print function.....	131
15.8.2	Continuous data output.....	132
15.8.3	GLP Output Function	134
15.8.4	Defining output details.....	135
15.10	USB connection	136
15.10.1	Edit weighing data, adjustment logs and screenshots to USB medium	137
15.10.2	Data transfer by means of barcode reader	140
16	Servicing, maintenance, disposal	141
16.1	Cleaning	141
16.2	Servicing, maintenance	142
16.3	Disposal.....	143
17	Instant help for troubleshooting.....	143
18	Ionizer	145
18.1	General hints.....	145
18.2	Basic Safety Precautions	145
18.3	Technical data.....	147
18.4	Commissioning.....	148
18.5	Maintenance & Cleaning	150

1 Technical data

KERN	ABP 100-4M	ABP 100-5DM	ABP 100-5M
Item no./ Type	TABP 100-4M-A	TABP 100-5DM-A	TABP 135-5M-A
Readability (d)	0.0001 g	0.00001 g/0.0001 g	0.00001 g
Weighing range (max)	120 g	52 g/120 g	135 g
Minimum load (Min)	0.01 g	0.001 g	0.001 g
Verification value (e)	0.001 g	0.001 g	0.001 g
Verification class	I	I	I
Reproducibility	0.0001 g	0.00002 g / 0.0001 g	0.00005 g
Linearity	± 0.0002 g	± 0.00005g /0.0002g	± 0.0002 g
Stabilization time	2 s	2 s / 8 s	8 s
Adjustment weight	internal		
Warm-up time	8 h		
Weighing Units	mg, g, ct (verified)		
Smallest component weight for part counting	1mg (under lab conditions*)		
	10 mg (under normal conditions**)		
Reference quantities at piece counting	1 - 100		
Weighing plate, stainless steel	ø 91mm		
Dimensions caisse (l x L x h) [mm]	212 x 367 x 345	212 x 411 x 345	212 x 411 x 345
Dimensions Glass wind screen [mm]	170 x 165 x 220 mm (weighing space)		
Net weight (kg)	7	8	8
Permissible ambient condition	+10° C to +30° C		
Humidity of air	20 ~ 85 % relative (not condensing)		
Power supply unit Input voltage	AC 100 -240 V, 320 – 190 mA 50/60Hz		
Balance Input voltage	DC 12 V, 1.0 A		
Degree of pollution	2		
Overvoltage category	Category II		
Metres in height	Up to 2000 m		
Place of installation	In sealed rooms only		
Interfaces	RS-232, USB (type B, PC connection), USB host (type A)		

KERN	ABP 200-4M	ABP 200-5DM	ABP 200-5M
Item no./ Type	TABP 200-4M-A	TABP 200-5DM-A	TABP 220-5M-A
Readability (d)	0.0001 g	0.00001 g/0.0001 g	0.00001 g
Weighing range (max)	220 g	102 g/220 g	220 g
Minimum load (Min)	0.01 g	0.001 g	0.02 g
Verification value (e)	0.001 g	0.001 g	0.001 g
Verification class	I	I	I
Reproducibility	0.0001 g	0.00005 g / 0.0001 g	0.000015 g@20g 0.0003 g@100g 0.0005 g@200g
Linearity	± 0.0002 g	± 0.0001 g / 0.0002 g	± 0.0001 g
Stabilization time	2 s	2 s / 8 s	8 s
Adjustment weight	internal		
Warm-up time	8 h		
Weighing Units	mg, g, ct (verified)		
Smallest component weight for part counting	1 mg (under lab conditions*)		
	10 mg (under normal conditions**)		
Reference quantities at piece counting	1 - 100		
Weighing plate, stainless steel	ø 91mm		
Dimensions caisse (l x L x h) [mm]	212 x 367 x 345	212 x 411 x 345	212 x 411 x 345
Dimensions Glass wind screen [mm]	170 x 165 x 220 mm (weighing space)		
Net weight (kg)	7	8	8
Permissible ambient condition	+10° C to +30° C		
Humidity of air	20 ~ 85 % relative (not condensing)		
Power supply unit Input voltage	AC 100 -240 V, 320 – 190 mA 50/60Hz		
Balance Input voltage	DC 12 V, 1.0 A		
Degree of pollution	2		
Overvoltage category	Category II		
Metres in height	Up to 2000 m		
Place of installation	In sealed rooms only		
Interfaces	RS-232, USB (type B, PC connection), USB host (type A)		

KERN	ABP 300-4M
Item no./ Type	TABP 300-4M-A
Readability (d)	0.0001 g
Weighing range (max)	320 g
Minimum load (Min)	0.01 g
Verification value (e)	0.001 g
Verification class	I
Reproducibility	0.00015 g
Linearity	± 0.0003 g
Stabilization time	2 s
Adjustment weight	internal
Warm-up time	8 h
Weighing Units	mg, g, ct (verified)
Smallest component weight for part counting	1mg (under lab conditions*)
	10 mg (under normal conditions**)
Reference quantities at piece counting	1 - 100
Weighing plate, stainless steel	ø 91mm
Dimensions caisse (l x L x h) [mm]	212 x 367 x 345
Dimensions Glass wind screen [mm]	170 x 165 x 220 mm (weighing space)
Net weight (kg)	7
Permissible ambient condition	+10° C to +30° C
Humidity of air	20 ~ 85 % relative (not condensing)
Power supply unit Input voltage	AC 100 -240 V, 320 – 190 mA 50/60Hz
Balance Input voltage	DC 12 V, 1.0 A
Degree of pollution	2
Overvoltage category	Category II
Metres in height	Up to 2000 m
Place of installation	In sealed rooms only
Interfaces	RS-232, USB (type B, PC connection), USB host (type A)

KERN	ABP 100-5DAM	ABP 100-5AM	ABP 200-4AM
Item no./ Type	TABP 120-5DAM-A	TABP 135-5AM-A	TABP 220-4M-A
Readability (d)	0.00001 g/0.0001 g	0.00001 g	0.0001 g
Weighing range (max)	52 g/120 g	135 g	220 g
Minimum load (Min)	0.001 g	0.001 g	0.01 g
Verification value (e)	0.001 g	0.001 g	0.001 g
Verification class	I	I	I
Reproducibility	0.00002 g / 0.0001 g	0.00005 g	0.0001 g
Linearity	± 0.00005g /0.0002g	± 0.0001 g	± 0.0002 g
Stabilization time	2 s / 8 s	8 s	2 s
Adjustment weight	internal		
Warm-up time	8 h		
Weighing Units	mg, g, ct (unverified)		
Smallest component weight for part counting	1 mg (under lab conditions*)		
	10 mg (under normal conditions**)		
Reference quantities at piece counting	1 - 100		
Weighing plate, stainless steel	ø 91 mm		
Dimensions caisse (l x L x h) [mm]	212 x 411 x 345	212 x 411 x 345	212 x 367 x 345
Dimensions Glass wind screen [mm]	170 x 165 x 220 mm (weighing space)		
Net weight (kg)	9.7	9.7	8.6
Permissible ambient condition	+10° C to +30° C		
Humidity of air	20 ~ 85 % relative (not condensing)		
Power supply unit Input voltage	AC 100 -240 V, 480 mA 50/60Hz		
Balance Input voltage	DC 12 V, 1.5 A		
Degree of pollution	2		
Overvoltage category	Category II		
Metres in height	Up to 2000 m		
Place of installation	In sealed rooms only		
Interfaces	RS-232, USB (type B, PC connection), USB host (type A)		

KERN	ABP 200-5DAM	ABP 200-5AM	ABP 300-4AM
Item no./ Type	TABP 220-5DM-A	TABP 220-5M-A	TABP 320-4AM-A
Readability (d)	0.00001 g/0.0001 g	0.00001 g	0.0001 g
Weighing range (max)	102 g/220 g	220 g	320 g
Minimum load (Min)	0.001 g	0.001 g	0.01 g
Verification value (e)	0.001 g	0.001 g	0.001 g
Verification class	I	I	I
Reproducibility	0.00005 g / 0.0001 g	0.000015 g@20g 0.0003 g@100g 0.0005 g@200g	0.00015 g
Linearity	± 0.0001g / 0.0002g	± 0.0001 g	± 0.0003 g
Stabilization time	2 s / 8 s	8 s	2 s
Adjustment weight	internal		
Warm-up time	8 h		
Weighing Units	mg, g, ct (unverified)		
Smallest component weight for part counting	1 mg (under lab conditions*)		
	10 mg (under normal conditions**)		
Reference quantities at piece counting	1 - 100		
Weighing plate, stainless steel	ø 91mm		
Dimensions caisse (l x L x h) [mm]	212 x 411 x 345	212 x 411 x 345	212 x 367 x 345
Dimensions Glass wind screen [mm]	170 x 165 x 220 mm (weighing space)		
Net weight (kg)	9.7	9.7	8.6
Permissible ambient condition	+10° C to +30° C		
Humidity of air	20 ~ 85 % relative (not condensing)		
Power supply unit Input voltage	AC 100 -240 V, 480 mA 50/60Hz		
Balance Input voltage	DC 12 V, 1.5 A		
Degree of pollution	2		
Overvoltage category	Category II		
Metres in height	Up to 2000 m		
Place of installation	In sealed rooms only		
Interfaces	RS-232, USB (type B, PC connection), USB host (type A)		

*** Smallest component weight for part counting - under lab conditions:**

- There are ideal ambient conditions for high-resolution counting
- The parts to be counted are not scattered

**** Smallest component part for part counting – under normal conditions:**

- There are unsteady ambient conditions (draft, vibrations)
- The parts to be counted are being scattered

2 Declaration of conformity

The current EC/EU Conformity declaration can be found online in:

www.kern-sohn.com/ce

- i** For verified weighing scales (= weighing scales assessed for conformity) the declaration of conformity is included in the scope of delivery.

3 Appliance overview

3.1 Components

Models d = 0.0001 g

Models d = 0.00001 g

(only ABP-A series)

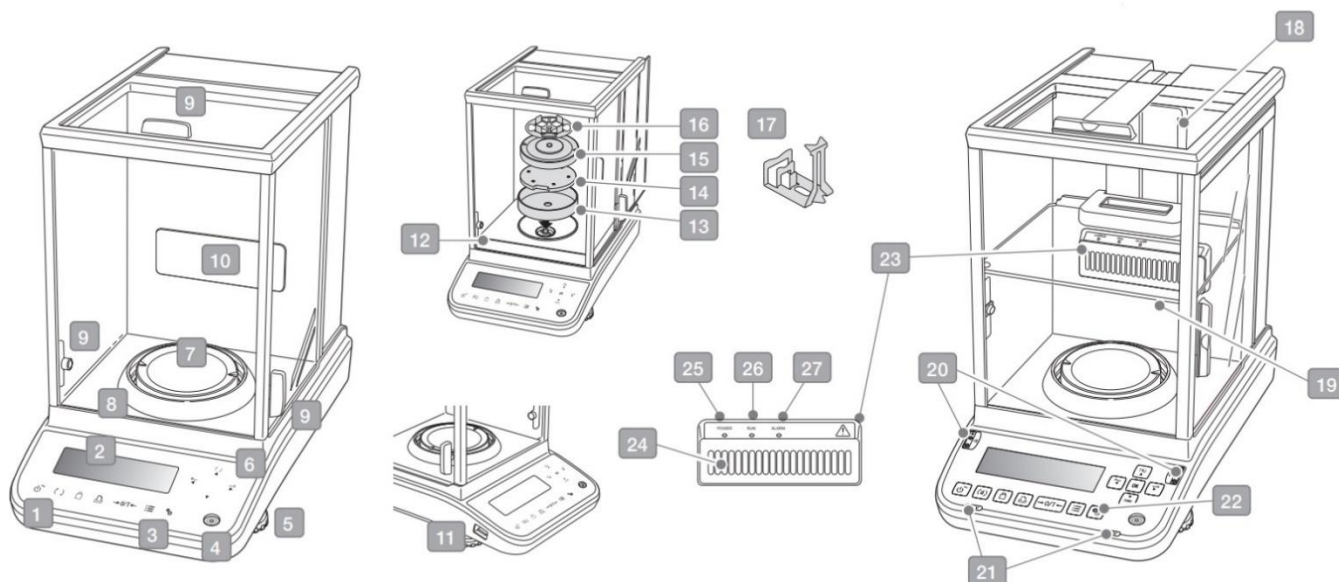

Pos.	Designation	Pos.	Designation
1	Keyboard	15	Support multi-function weighing plate
2	Display	16	Multi-function weighing plate
3	Ionizer button	17	Test tube holder (ABP 200-5M / ABP 200-5AM only)
4	Bubble level	18	Guide rail internal windshield (Models d = 0.0001 g of ABP-A only)
5	Levelling screw	19	Adjustable internal windshield (Models d = 0.0001 g of ABP-A only)
6	Control buttons +	20	IR sensors
7	Weighing pan	21	Door opening and closing buttons
8	Windshield	22	Ionizer button
9	Knob for glass windshield	23	Ionizer
10	Fastening point ionizer (optional)	24	Ventilation
11	USB host port	25	Power LED (ionizer)
12	Guard plate	26	RUN LED (ionizer)
13	Windshield	27	ALARM LED (ionizer)
14	Carrier weighing pan		

Rear view:

Models d = 0.0001 g

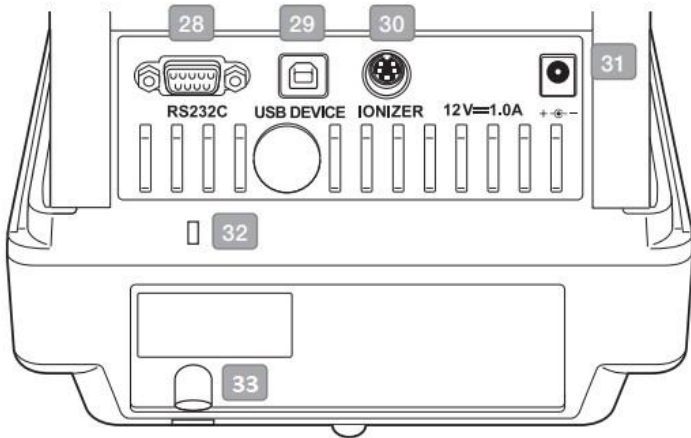

Models d = 0.00001 g

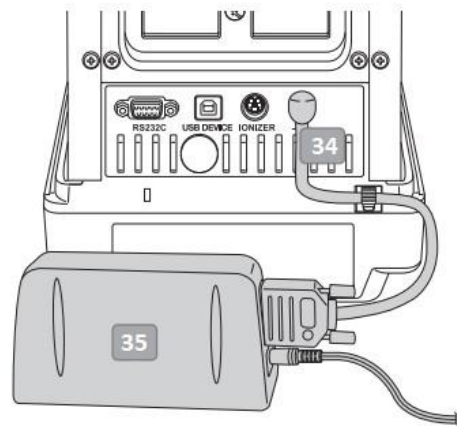

(only ABP-A series)

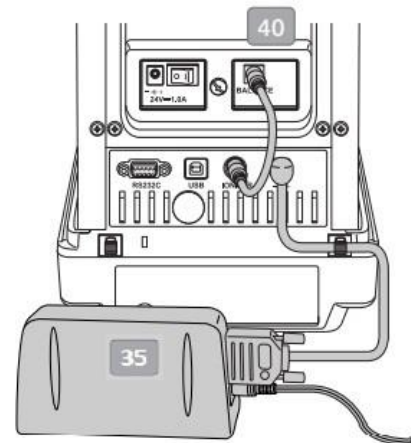
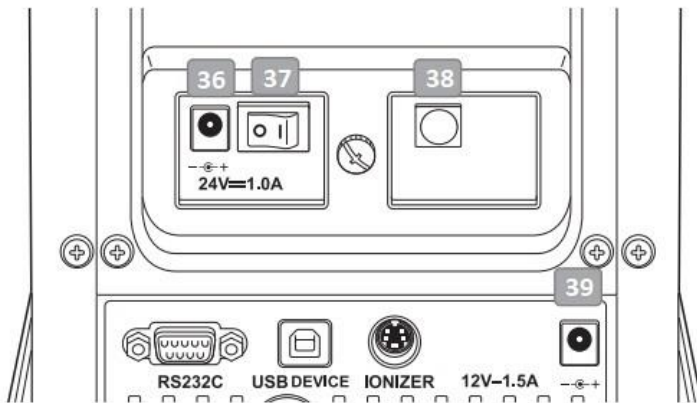

Pos. Designation

Pos. Designation

- 28 Serial interface (RS232)
- 29 USB device
- 30 Port for ionizer
- 31 Connector for AC adapter
- 32 Fastening point for anti-theft device
- 33 Fastening lug for anti-theft chain or wire
- 34 Port for power pack

- 35 Power Pack
- 36 Connector for AC adapter (ionizer)
- 37 Main switch (ionizer)
- 38 Connection for balance
- 39 Connector for AC adapter
- 40 Connecting cable for ionizer

3.2 Keyboard



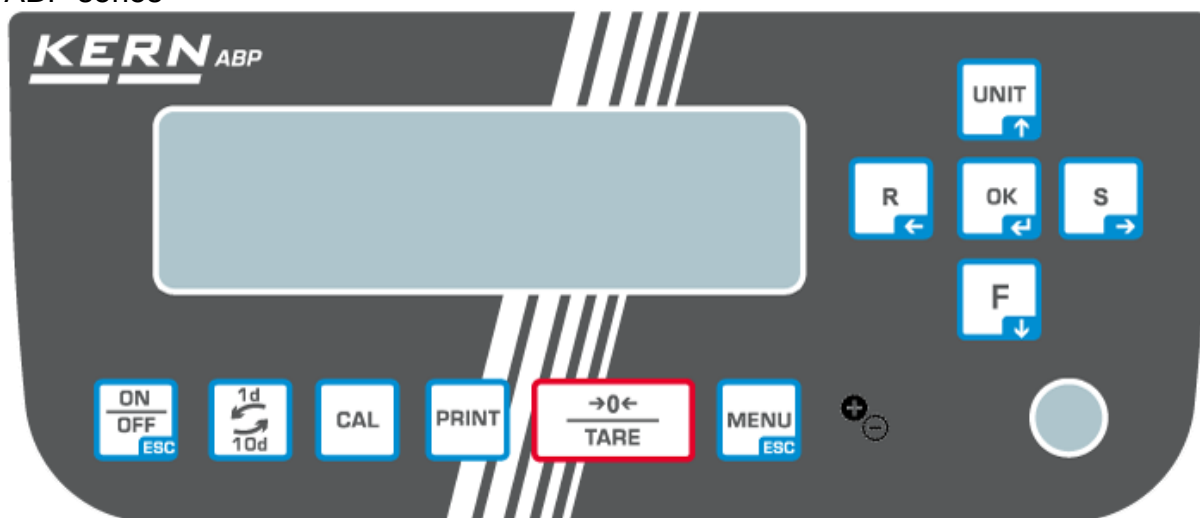



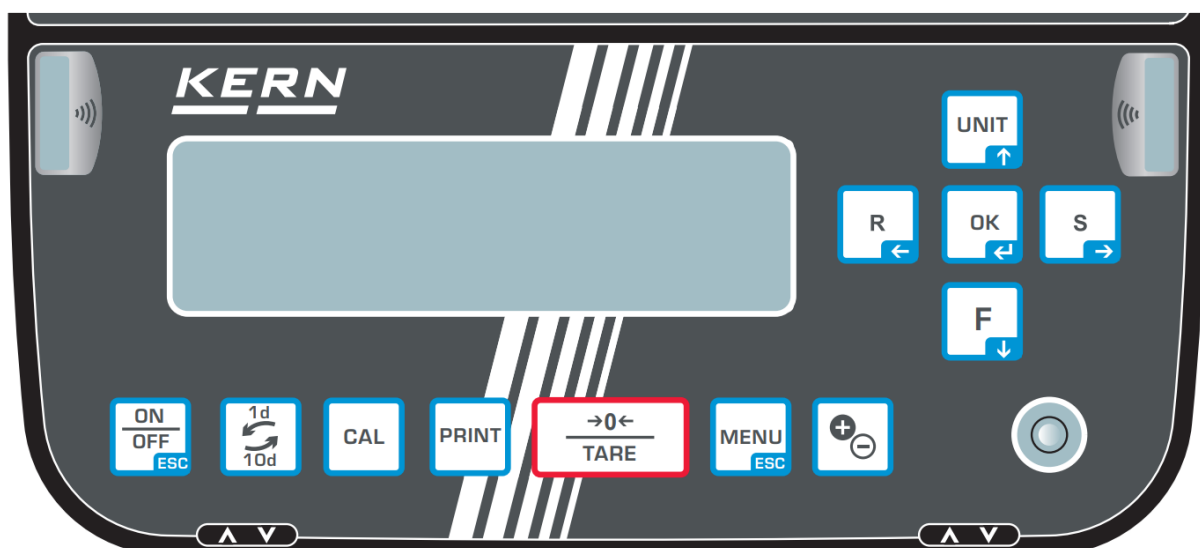



ABP series



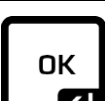





ABP-A series



Button	Designation	Function		
		Short key pressing	Long key pressing	In menu
	[ON/OFF]	Switching between operating and standby mode	-	Return to weighing mode
	[1d/10d]	Readability change	-	-
	[CAL]	Start adjustment	Call setup menu "Adjustment"	-

	[PRINT]	Data output to external device (weighing mode)	Call setup menu "Print"	-
	[TARE]	Taring Zeroing	Call setup "Zero Setting / Taring"	-
	[MENU]	<ul style="list-style-type: none"> • Call up menu • Call application specific settings • Call Statistics 	-	Return to weighing mode
	[Ionizer]	Starting the ionizer (ABP series Factory Option)	Call Setup Menu Ionizer (ABP Series Factory option)	-
	[OK]	-	-	Confirm input
	[R] Navigation key ←	Change response setting for display	-	Select menu item.
	[UNIT] Navigation key ↑	Weighing mode: Switch-over weighing unit. Counting mode: Display single weight Calculate percentage: Display reference weight	Call setup menu "Units"	Scroll forward in menu
	[F] Navigation key ↓	Switch over weighing mode / application mode	-	Scroll backwards in menu
	[S] Navigation key →	Change stability setting of display	-	Select menu item.
	Door opening and closing buttons	Opens / closes the glass doors	-	Opens / closes the glass doors

3.2.1 Numeric entry

Button	Designation	Function
	Navigation key ↑	Flashing digit (0 – 9) or increase character (, [blank], -, A – Z)
	Navigation key ↓	Flashing digit (0 – 9) or reduce character (, [blank], -, A – Z)
	Navigation key →	Digit selection to the right
	Navigation key ←	Digit selection to the left
	Navigation button ↵	Confirm entry
	ESC	Cancel input

3.3 Display

Apart from the display of the weighing result, all functions of the menu may be accessed from here. The display will vary, depending on the weighing scale being either in operating or setting mode.













Special keys (e.g. CAL-, TARE-, PRINT-key) provide fast and purposeful access to the individual setup menu. The navigation keys allow intuitive control.

Display example operating mode:

The display is sub-divided into four areas.



No.	Status	Description
1	Operating mode	Current application
2	User field	Display of logged-in user and current time
		Data output to external devices
		USB-storage medium is connected
		Menu Lock
3	Weighing value	Display of weighing result in current weighing unit
		Stability display
		Net weight
		Tare weight
		Gross weight
		Hold function enabled
		Zero display
		Negative weighed value
		Net weight during recipe composition
		Tolerance mark
		Capacity display
		The non-verified value is given in brackets in verified scales.



4	Status display	Current settings		
			Minimum initial weight	
			Settings for Stability and Response	
		Printer settings		
			Auto Print function active	
			Flashing during automatic Output	
			continuous output enabled	
			Flashing during continuous Output	
		Weighing settings		
			Dispensing mode	
			Zero tracking (auto. zero point correction)	
			Statistics	
		Error messages		
			Adjustment required (PSC-function)	
	Inadequate power supply			
	Defective USB-connection			

Display example setting mode:

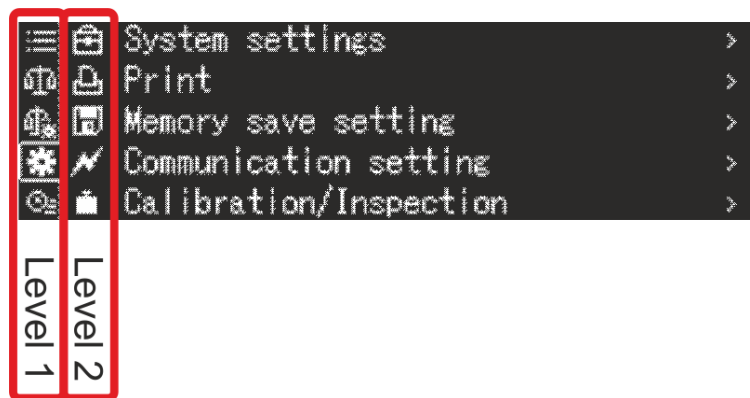



After pressing the MENU-key in weighing mode the display will change to setting mode.



Example of application: System settings, see chap. 11.1.3

Symbol	Description	Application icons
 Level 1	Selecting an application	 <ul style="list-style-type: none"> Weighing mode Piece counting Percent determination Density determination <Solid matter> Density determination <Liquid> Totalization Recipe composition Recipe preparation Buffer solution preparation Sample preparation

The icon for the application selected will be shown

Symbol	Description	Application icons
 Level 2	Icon of selected application	Available settings will be shown on level 1.
 Level 1	Weighing settings	 <ul style="list-style-type: none"> Dosing Zero tracking Balance settings Settings <Print> Settings <Save data> Settings <Communication> Settings <Adjustment> Settings <User>
 Level 1	System Settings	

 Level 1	History	The last 10 menu steps will be displayed.
--	---------	---

i Further information about navigation in the menu you will find in chap. 11.1

4 Basic Information (General)

4.1 Proper use

The balance you purchased is intended to determine the weighing value of material to be weighed. It is intended to be used as a “non-automatic balance”, i.e. the material to be weighed is manually and carefully placed in the center of the weighing pan. As soon as a stable weighing value is reached, the weighing value can be read.

4.2 Improper Use

Our balances are non-automatic balances and not provided for use in dynamic weighing processes. However, the balances can also be used for dynamic weighing processes after verifying their individual operative range, and here especially the accuracy requirements of the application.

Do not leave permanent load on the weighing pan. This may damage the measuring system.

--

Impacts and overloading exceeding the stated maximum load (max) of the balance, minus a possibly existing tare load, must be strictly avoided. Balance may be damaged by this.

Never operate the balance in explosive environment. The serial version is not explosion protected.

The structure of the balance may not be modified. This may lead to incorrect weighing results, safety-related faults and destruction of the balance.

The balance may only be used according to the described conditions. Other areas of use must be released by KERN in writing.

4.3 Warranty

Warranty claims shall be voided in case:

- Our conditions in the operation manual are ignored
- The appliance is used beyond the described uses
- The appliance is modified or opened
- Mechanical damage or damage by media, liquids, natural wear and tear
- The appliance is improperly set up or incorrectly electrically connected
- The measuring system is overloaded

4.4 Monitoring of Test Resources

In the framework of quality assurance the measuring-related properties of the balance and, if applicable, the testing weight, must be checked regularly. The responsible user must define a suitable interval as well as type and scope of this test. Information is available on KERN's home page (www.kern-sohn.com) with regard to the monitoring of balance test substances and the test weights required for this. In KERN's accredited DKD calibration laboratory test weights and balances may be calibrated (return to the national standard) fast and at moderate cost.

5 Basic Safety Precautions

5.1 Pay attention to the instructions in the Operation Manual



- ⇒ Carefully read this operation manual before setup and commissioning, even if you are already familiar with KERN balances.
- ⇒ All language versions contain a non-binding translation. The original German is binding.

5.2 Personnel training

The appliance may only be operated and maintained by trained staff.

6 Transport and storage

6.1 Testing upon acceptance

When receiving the appliance, please check packaging immediately, and the appliance itself when unpacking for possible visible damage.

6.2 Packaging / return transport



- ⇒ Keep all parts of the original packaging for a possibly required return.
- ⇒ Only use original packaging for returning.
- ⇒ Prior to dispatch disconnect all cables and remove loose/mobile parts.

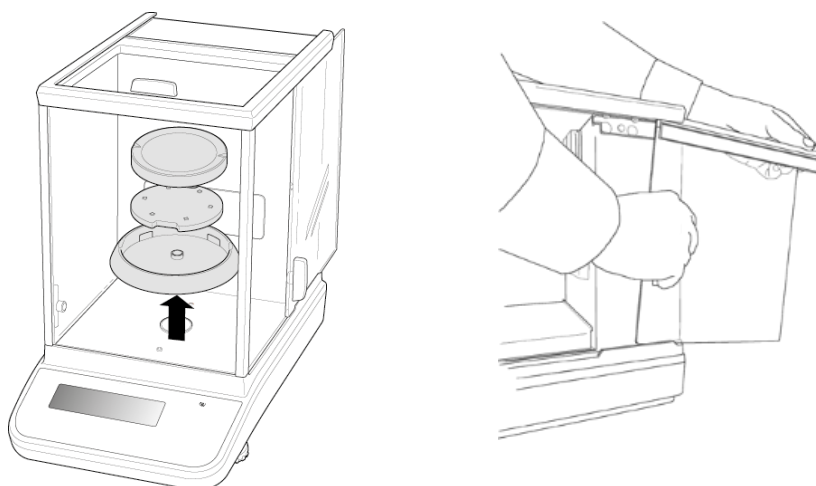
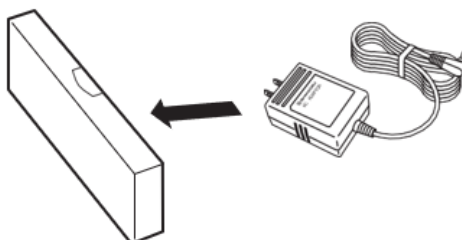
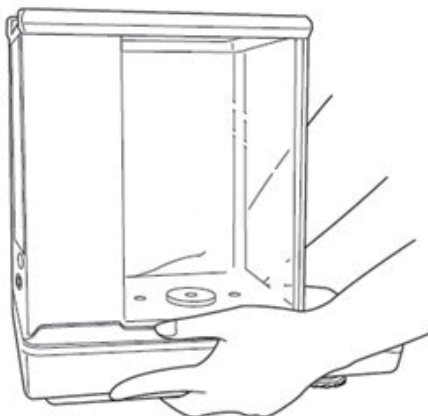

Image example models $d = 0.0001$ g

- ⇒ Reattach possibly supplied transport securing devices.
- ⇒ Secure all parts such as the glass wind screen, the weighing plate, power unit etc. against shifting and damage.



- ⇒ Put AC adapter and accessories in the small box



⇒ Lift scale with both hands

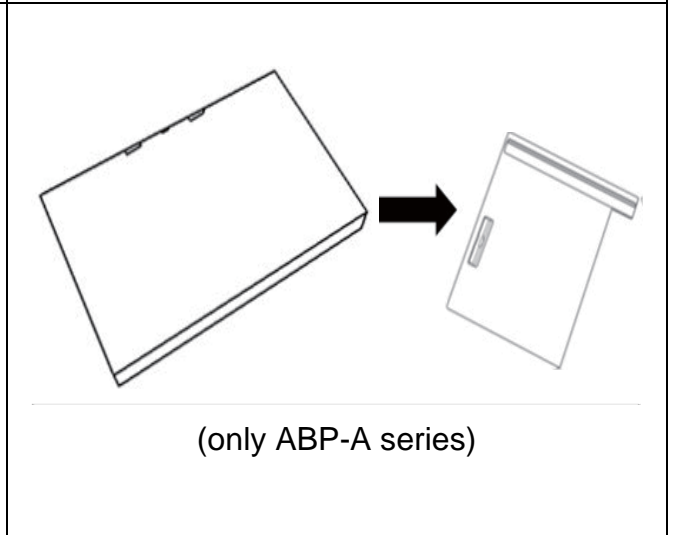
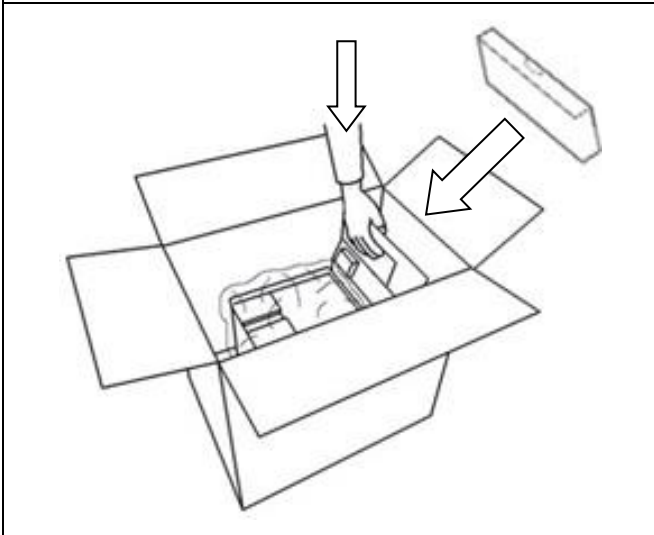
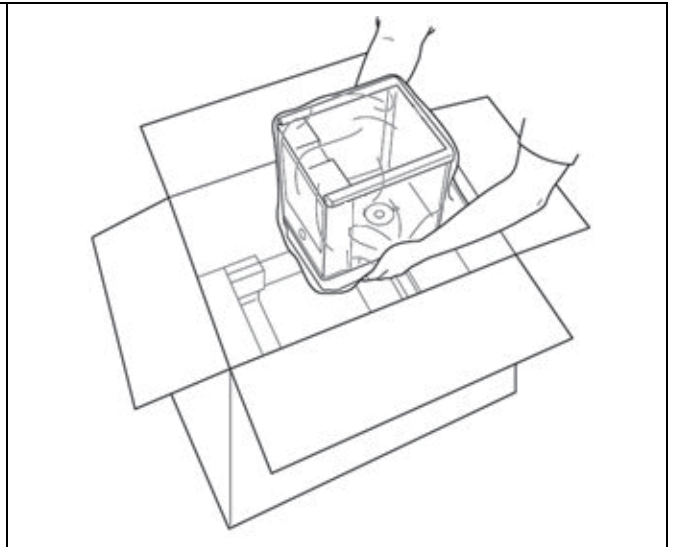
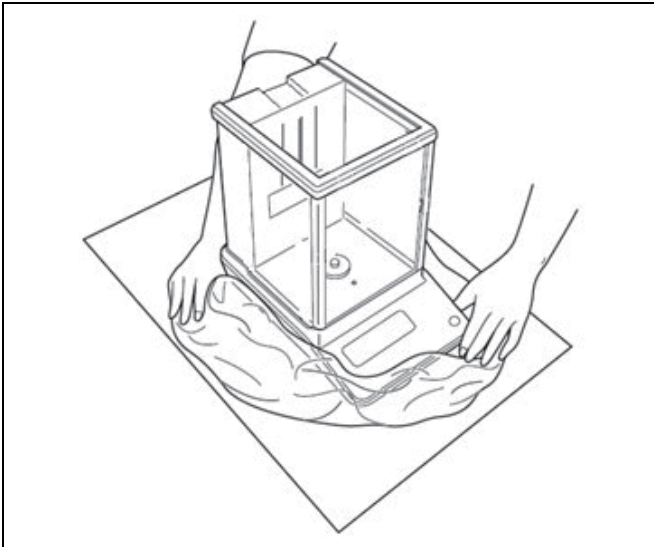

(only ABP-A series)

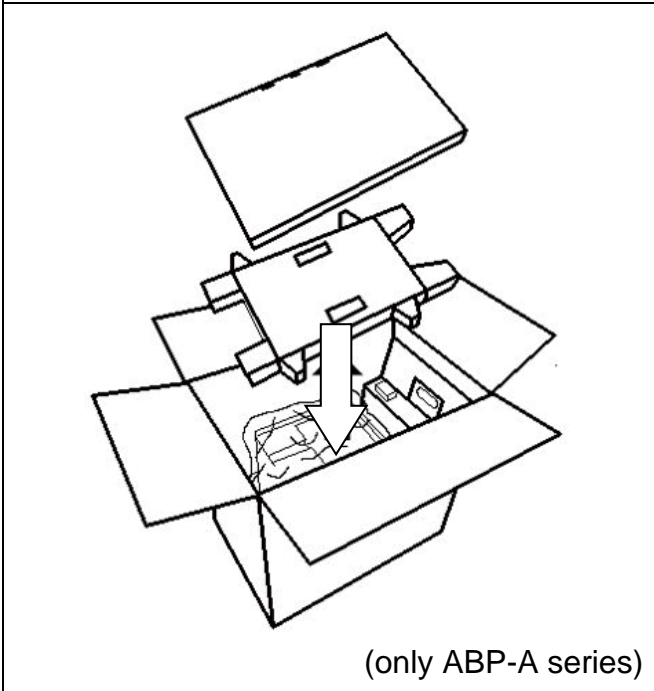

(only ABP-A series)

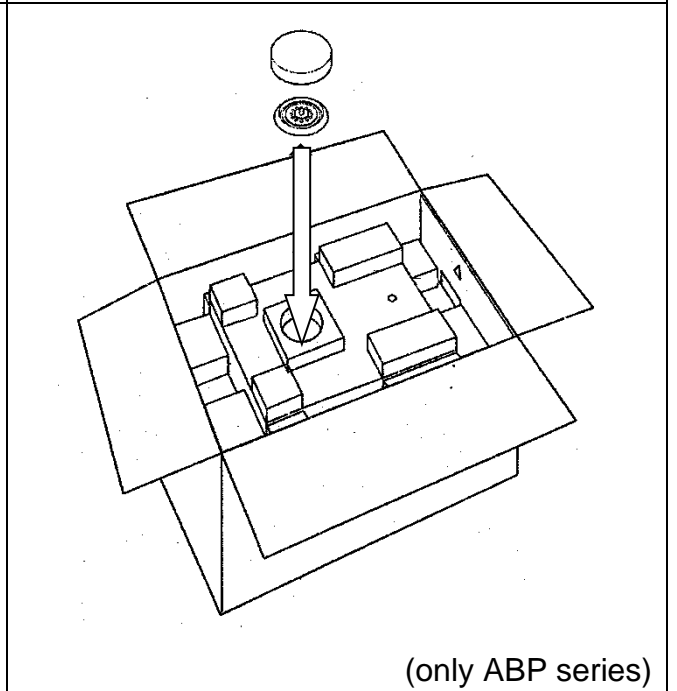

(only ABP series)

7 Unpacking, Installation and Commissioning

7.1 Installation Site, Location of Use

The balances are designed in a way that reliable weighing results are achieved in common conditions of use.

You will work accurately and fast, if you select the right location for your balance.

Therefore, observe the following for the installation site:

- Place the balance on a firm, level surface;
- Avoid extreme heat as well as temperature fluctuation caused by installing next to a radiator or in the direct sunlight;
- Protect the balance against direct draughts due to open windows and doors;
- Avoid jarring during weighing;
- Protect the balance against high humidity, vapours and dust;
- Do not expose the device to extreme dampness for longer periods of time. Non-permitted condensation (condensation of air humidity on the appliance) may occur if a cold appliance is taken to a considerably warmer environment. In this case, acclimatize the disconnected appliance for ca. 2 hours at room temperature.
- Avoid static charge of weighed items or weighing container.

If electro-magnetic fields or static charge occur, or if the power supply is unstable major deviations on the display (incorrect weighing results) are possible. In that case, the location must be changed.

7.2 Unpacking and check

Remove device and accessories from packaging, remove packaging material and install the device at the planned work place. Check if that there has been no damage and that all items of delivery scope are present.

Scope of delivery / serial accessories

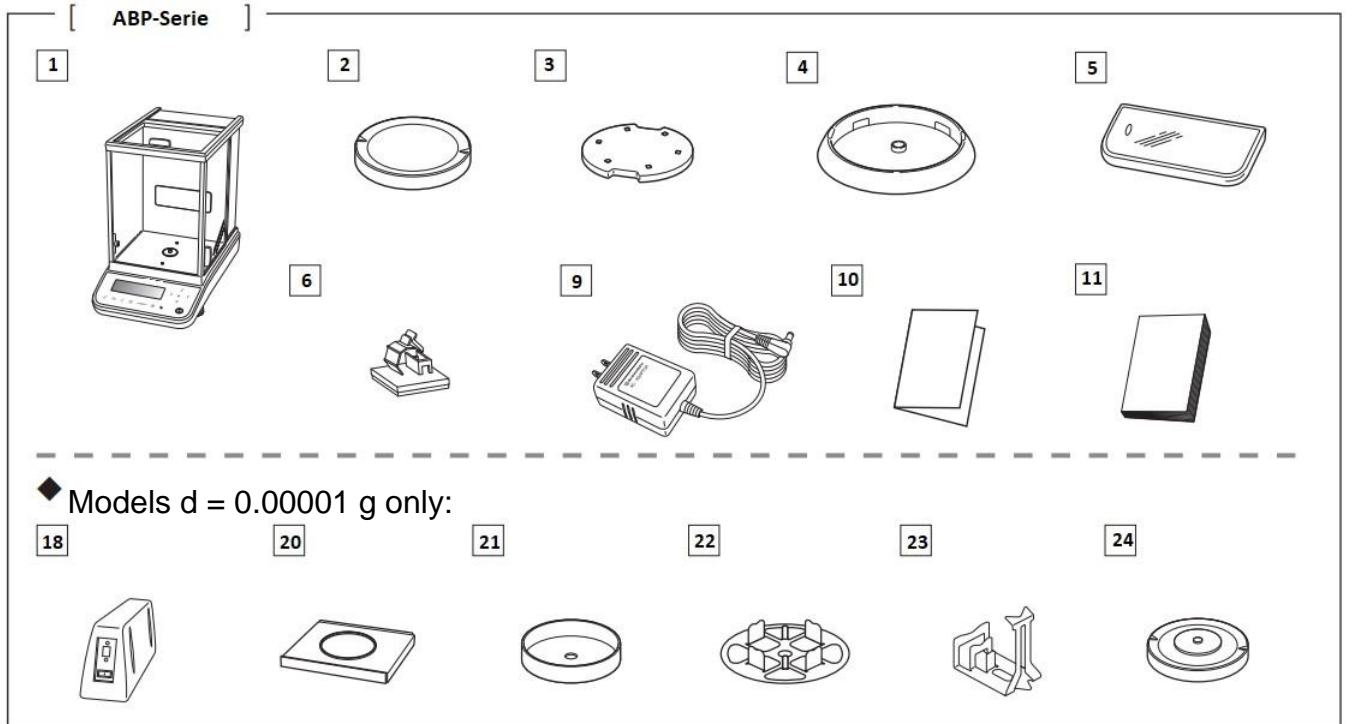
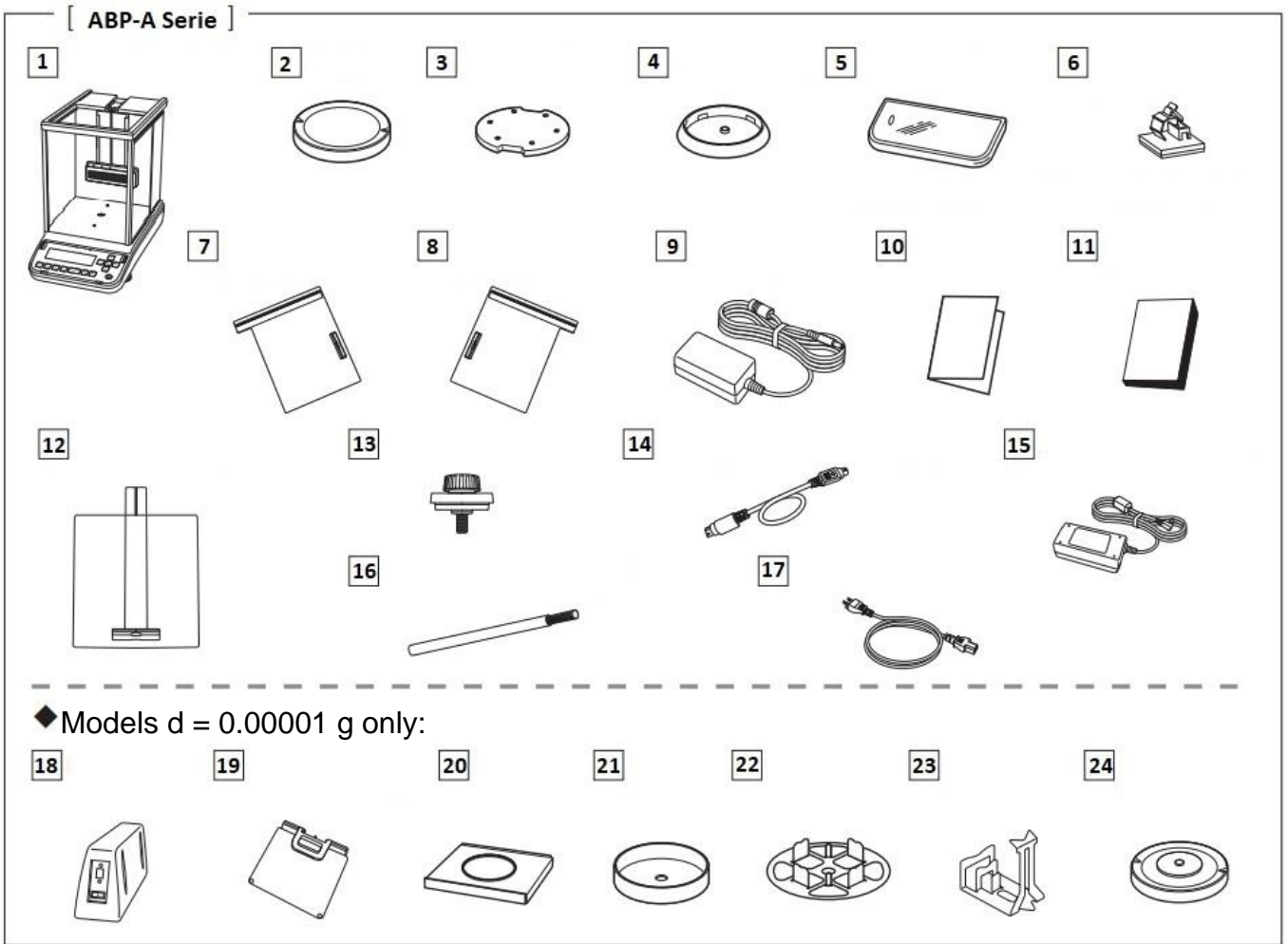

Pos.	Designation	Pos.	Designation
1	Balance	13	Stopper knobs [3]
2	Weighing pan	14	Connecting cable ionizer
3	Carrier weighing pan	15	AC adapter ionizer
4	Centring ring (Models d = 0.0001 g only)	16	Cleaning brush ionizer
5	Protective hood	17	Net cable ionizer
6	Holder for adapter cable (Models d = 0.0001 g only)	18	Power Pack
7	Glass door (left)	19	Adjustable internal windshield
8	Glass door (right)	20	Guard plate
9	AC adapter balance	21	Windshield
10	Menu Map	22	Multi-function weighing plate
11	Operating instructions	23	Test tube holder (ABP 200-5M / ABP 200-5AM only)
12	Glass door (Top)	24	Support multi-function weighing plate

7.3 Placing

7.3.1 Installing the glass windshield doors (only ABP-A series)



Make sure that the stopper knobs are attached to the glass doors (top, left, right) before switching-on the device. Otherwise the glass doors could be damaged.

Installation of the glass windshield door (top)

Insert the handle of the glass door (top) from the front side of the upper part and fasten the stopper knob from inside of the weighing space in a way that it is in a parallel position to the handle as shown in the figure on the right.

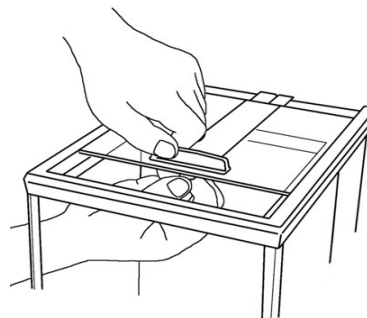

If the stopping section of the stopper knob protrudes farther than the handle, the door cannot be completely closed; so install it in a manner that it is in a parallel position to the handle.

Installation of the glass windshield door (right)

Keep the handle of the glass door (right) with the right hand and the upper edge with the left hand and insert the lower edge of the glass door into the right rail of the balance, as shown in the figure on the right.

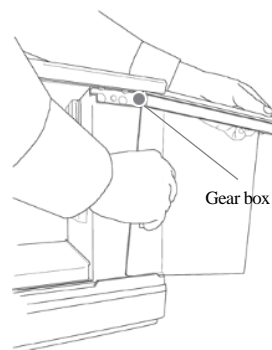

Align the rail to the upper groove of the housing and lift your left hand a little bit in order to bring the glass door into a horizontal position, then slowly insert the glass door. Close the glass door halfway and attach the stopper knob from the inside of the weighing space, so that it is in a parallel position to the handle.

If the stopping section of the stopper knob protrudes farther than the handle, the door cannot be completely closed; so install it in a manner that it is in a parallel position to the handle. See for this the figure on the right.

Ensure that you don't touch the toothed rack of the glass door, the motor driving wheel etc. and that no dirt or foreign body gets in the transmission gear. Otherwise damages may occur.

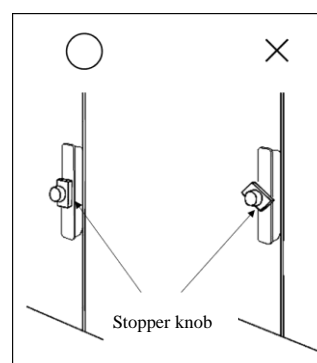

Installation of the glass windshield door (left)

Fasten this door in the same way like the right-hand glass door.

7.3.2 Assembly of the internal windshield

(only ABP-A Semi-Micro models)

Internal windshield

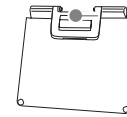

Open the glass door completely (top)

Take hold of the handle of the adjustable windshield pane with your preferred hand. Insert the adjustable windshield pane slowly and carefully from the upper opening in order to avoid that the glass door is touched.

Introduce the pin in the lower middle of the internal windshield from front into the groove in the center of the guide rail.

Introduce the lower pins (on both sides) into the guide rail.

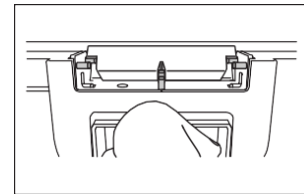
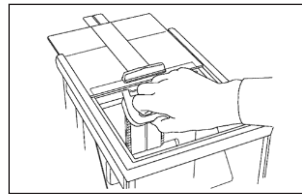
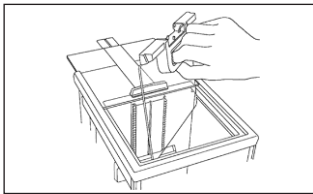

Insert the upper pins into the grooves, while keeping up the adjustable windshield plate in order to ensure that it is in horizontal position.

The internal windshield can be moved upwards and downwards by holding fast the handle and pulling the lever. Release the lever, the internal windshield is locked, when the handle is released.

Adjust the internal windshield in a way that the upper side of the internal windshield remains on the same level as the slideway.

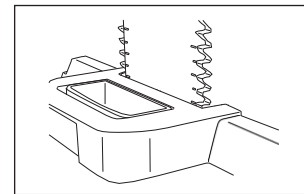
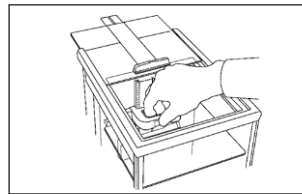
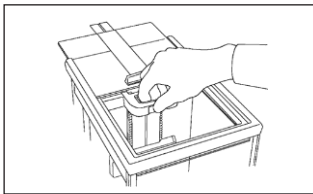

The internal windshield cannot be locked in any position in the middle of the guide rail. Make absolutely sure that the lever engages after releasing.

Adjust the position and use the internal windshield according to the samples/containers in a manner that it does not cause an obstacle.

7.3.3 Connection of the ionizer

see chap. 18.

Semi-Micro models

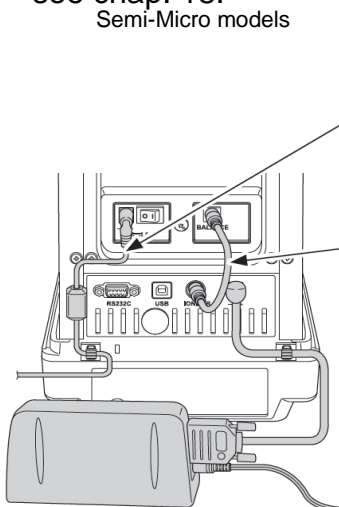

Plug the connected ionizer-AC adapter and the net cable into the DC IN-connection (for the ionizer). Connect the power plug of the ionizer to a plug-in socket.

Connect the connections of the ionizer (2 connections) on the backside of the ionizer with the ionizer connecting cable.

Attach the adapter cable holders on the backside of the main housing to the positions shown in the figure. Remove the backing paper from the holder, to uncover the adhesive surface, and press then the adhesive surface on the main housing in the alignment shown in the figure.

Excepted Semi-Micro models

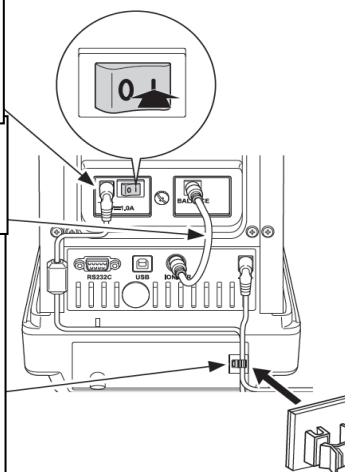

7.3.4 Installation of weighing plate

i The right place is decisive for the accuracy of the weighing results of high-resolution precision balances (see chap. 7.1).

1. Attach holder for adapter cable (Models d = 0.0001 g only)

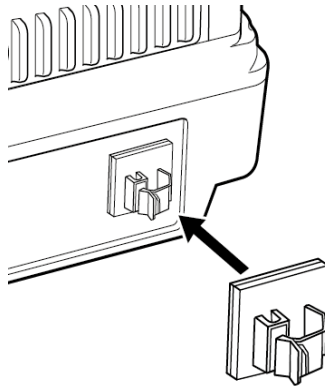

⇒ Pull off protective film and attach as shown on image.

2. Installation of weighing plate

Models d = 0.0001 g

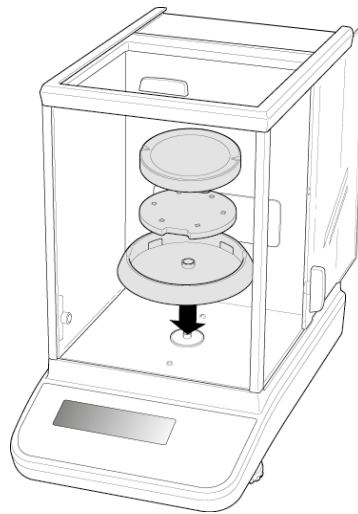

- ⇒ Attach centering ring, carrier of weighing plate and weighing plate in order.
- ⇒ Attach the safety hood

Models d = 0.00001 g

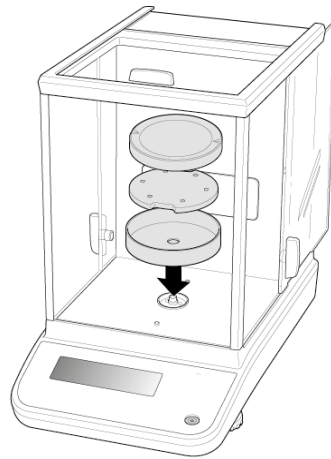

- ⇒ Attach centering ring, carrier of weighing plate and weighing plate in order.
- ⇒ Attach the safety hood

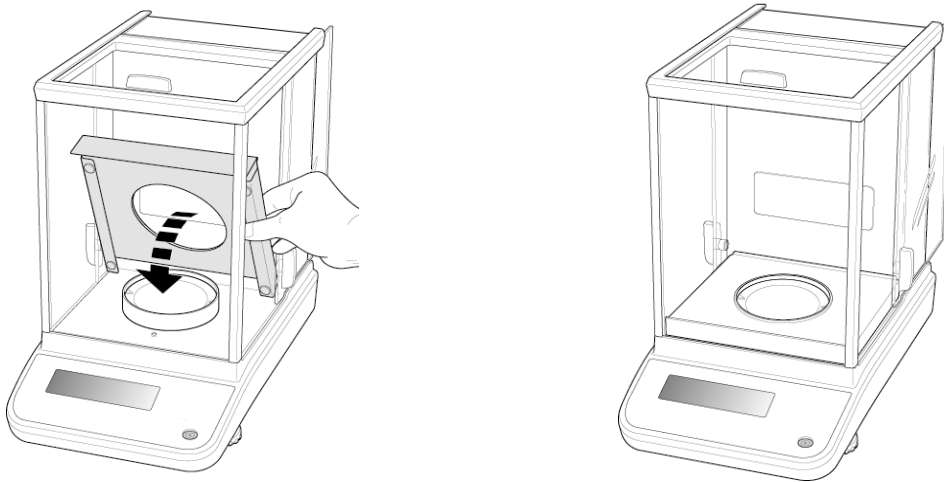

- ⇒ Place the guard plate carefully in the weighing chamber

3. Install the multi-function weighing plate (models d = 0.00001 g only)

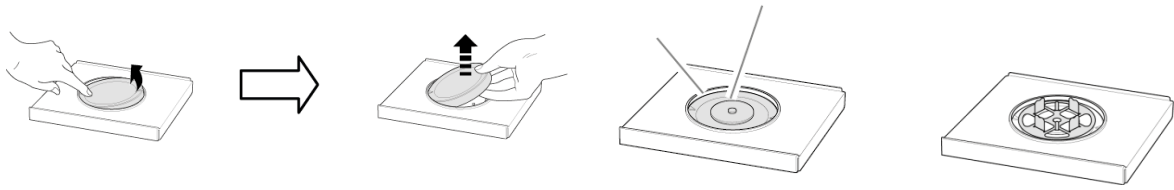

⇒ Disconnect scale from power supply.

⇒ Remove standard weighing plate as shown on illustration.

⇒ Install multi-function weighing plate together with the support. Pay due attention to centering!

Application examples:

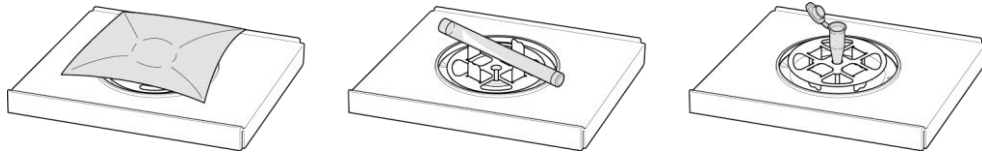

Adjustment will be required after exchanging the weighing plate, for instructions see chap. 8

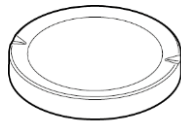

Standard weighing plate

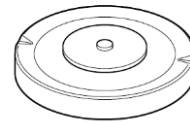

Support multi-function weighing plate

4. Install test tube holder (ABP 200-5M / ABP 200-5AM only)

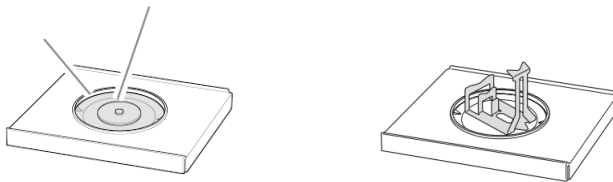

Application examples:

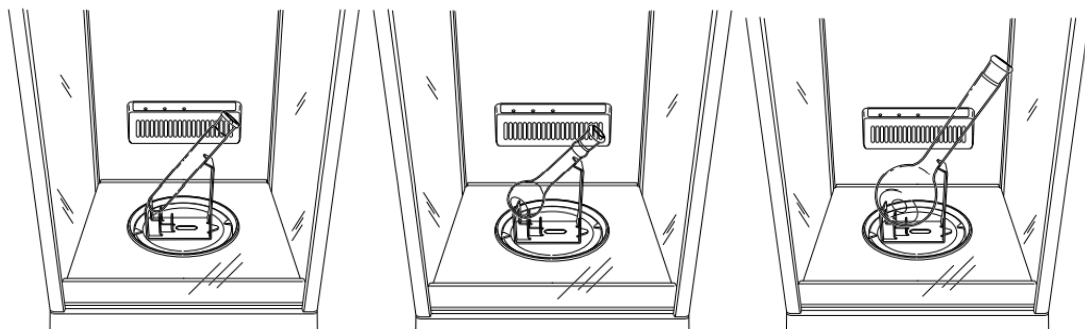

5. Levelling

- ⇒ Level balance with foot screws until the air bubble of the water balance is in the prescribed circle.

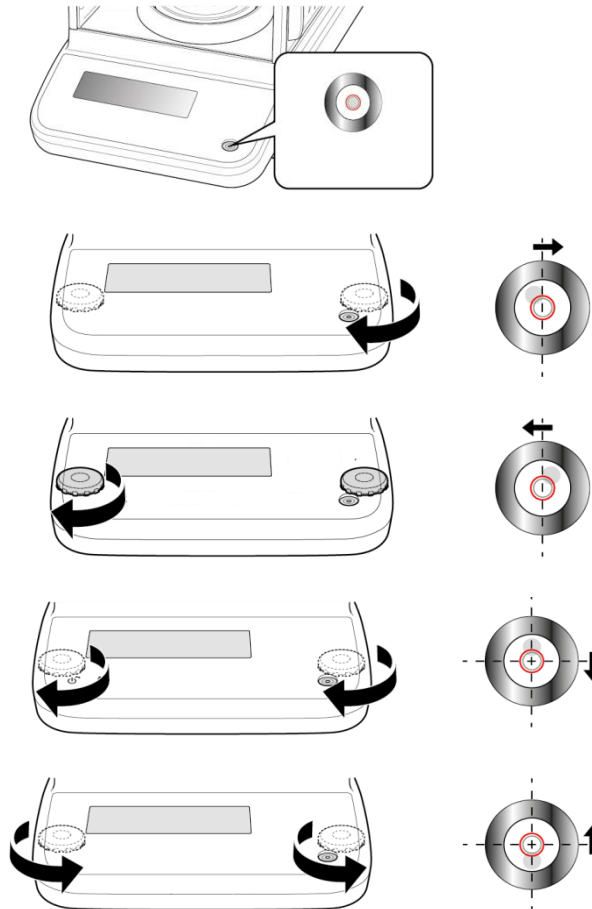

- ⇒ Check levelling regularly

7.4 Mains connection



Select a country-specific power plug and insert it in the mains adapter.



Check, whether the voltage acceptance on the scales is set correctly. Do not connect the scales to the power mains unless the information on the scales (sticker) matches the local mains voltage.

Only use KERN original mains adapter. Using other makes requires consent by KERN.



Important:

- Before starting your weighing balance, check the mains cable for damage.
- Ensure that the power unit does not come into contact with liquids.
- Ensure access to mains plug at all times.

7.4.1 Turning On the Power

Models d = 0.0001 g

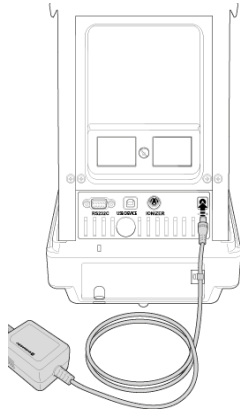

Supply power to balance via mains adapter. The display lights up and the balance carries out a selftest. Internal adjustment will be started automatically (See chap.8.3.2). The motor noise of the loading system for the internal adjustment weight will be audible.

You can cancel the adjustment by pressing the **ON/OFF** key.

The selftest is completed when „OFF“ appears on the display. From that point onwards the weighing scale will be in standby mode. The weighing balance will remain switched on as long as it is connected to the power supply.

To turn the display on/off, press the **ON/OFF** key.

When the log-in function is enabled, use the navigation keys to select the respective user and enter password, see chap. 12.8

Models d = 0.00001 g

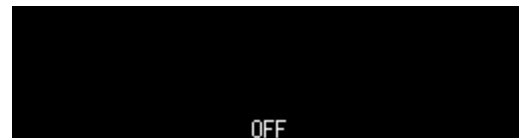
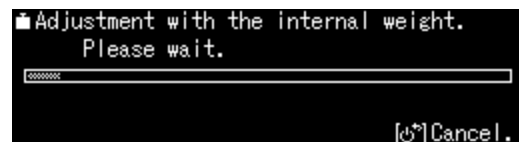
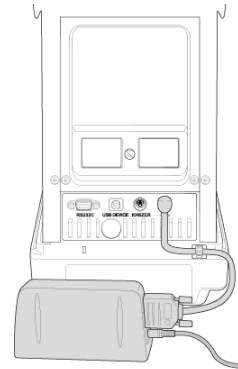

7.5 Initial Commissioning

In order to obtain exact results with the electronic balances, your balance must have reached the operating temperature (see warming up time chap.1). During this warming up time the balance must be connected to the power supply (mains, rechargeable accumulator or battery). The accuracy of the balance depends on the local acceleration of gravity. Strictly observe hints in chapter Adjustment.

7.6 Connection of peripheral devices

Before connecting or disconnecting of additional devices (printer, PC) to the data interface, always disconnect the balance from the power supply.

With your balance, only use accessories and peripheral devices by KERN, as they are ideally tuned to your balance.

8 Adjustment

As the acceleration value due to gravity is not the same at every location on earth, each balance must be coordinated - in compliance with the underlying physical weighing principle - to the existing acceleration due to gravity at its place of location (only if the balance has not already been adjusted to the location in the factory). This adjustment process must be carried out for the first commissioning, after each change of location as well as in case of fluctuating environment temperature. To receive accurate measuring values it is also recommended to adjust the balance periodically in weighing operation.

- i** • Observe stable environmental conditions. A warm up time (see chapter 1) is required for stabilization.
- Ensure that there are no objects on the weighing pan.
- Avoid vibration and air flow.
- Always carry out adjustment with the standard weighing plate in place.
- To cancel internal adjustment, press the **ON/OFF** key.
- When an optional printer is connected and the GLP function is connected, the adjustment log will be edited, see chap. 8.4

8.1 Automatic adjustment via PSC function

Force-compensated scales react sensitively to changes in temperature. The higher the sensitivity of the scale, the more pronounced the effect. The temperature controlled PSC function enables the scale to automatically correct this effect.

PCS stands for Perfect Self Calibration and facilitates fully automatic internal scale adjustment by means of an internal weight, based on time and/or temperature criteria.

Adjustment in weighing mode is carried out automatically under the following conditions:

- (1) If there is a change in ambient temperature (Δt 1°C)
- (2) When about four hours have passed since the previous adjustment
- (3) When the balance is switched from standby status to weighing mode and condition (1) or (2) has been met.

If one of the above conditions was met in weighing mode, the weight symbol  flashes for about two minutes in order to notify the pending adjustment;

During operation, the display will automatically change and the motor sound of the weight loading system is heard.

In order to ensure proper PSC operation, prevent vibrations and air flow.

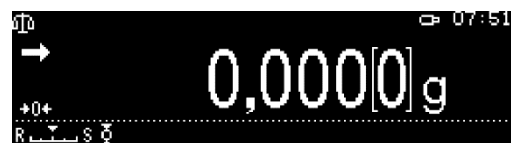
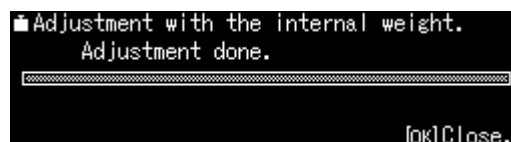
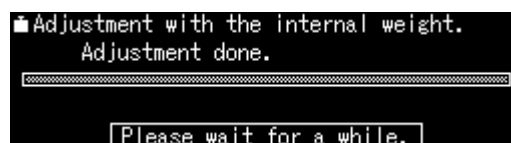
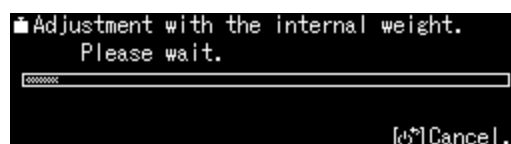



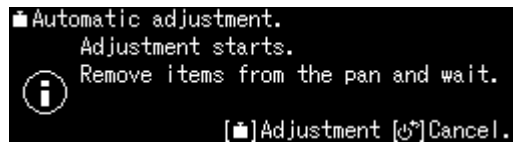
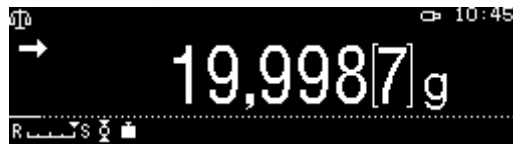

- The PSC function is always active and cannot be disabled.
- Also, no measurements can be made during automatic adjustment.
- When the weight symbol  starts flashing while the weighing plate is loaded the following message will appear



Unload weighing plate

- In order to prevent that adjustment is starting during a measuring sequence, press the **ON/OFF** key as soon as the weight symbol  appears. This will cancel adjustment and you can proceed with the measuring sequence.

Sometime later adjustment will be requested again by the flashing weight symbol .

8.2 Time-controlled automatic adjustment

With the help of its internal adjustment weight and integrated clock the balance can be set to carry out an automatic adjustment at set times (up to three times daily). This function is a very convenient function, when adjustment reports are desired to be made for regular adjustments, or when wishing span adjustments during break times to avoid interruption of measurement work.

The weight symbol  blinks for about two minutes as notification of span calibration before it begins. Automatic adjustment can be stopped by actuating the **[ON/OFF]** key during this message.

Parameter setting:

Press and hold the **CAL**-key for approx. 3 sec until the <CAL key setting> menu appears.

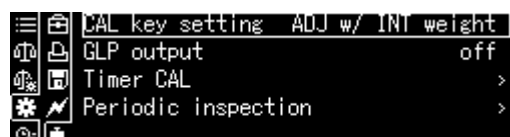

Use the navigation keys to select <CAL Timer> and confirm using the **OK**-key.

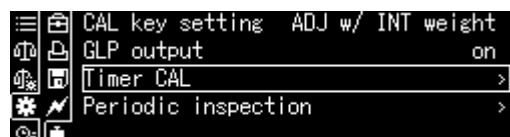

Select first time <Timer 1> and confirm using the **OK**-key.



Select settings [on] or [off] and confirm using the **OK**-key.



To set the time select [Settings] and confirm using the **OK**-key.



Use the navigation keys to enter time and confirm using the **OK**-key.

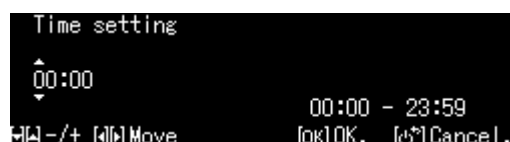

Repeat these operating steps to set the time for <Timer 2> / <Timer 3>.

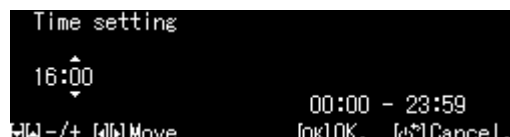

8.3 Manual adjustment via key [CAL-key]

8.3.1 Setting adjustment function for CAL-key

It is possible to start the preset adjustment procedure without having to access the menu. The Set Adjustment procedure may be set by simply pressing the [CAL]-key when in weighing mode.

Press and hold the **CAL**-key for approx. 3 sec until the <CAL key setting> menu appears.

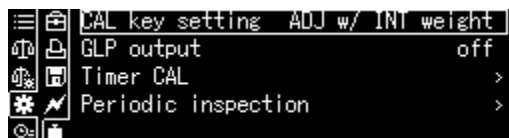

Confirm using the **OK**-key and the available settings will be displayed.

- Adjustment with internal weight, see chap. 8.3.2
- For adjustment test using internal weight see chap. 8.3.3
- Adjustment with external weight, see chap. 8.3.4
- Adjustment test with external weight, see chap. 8.3.5

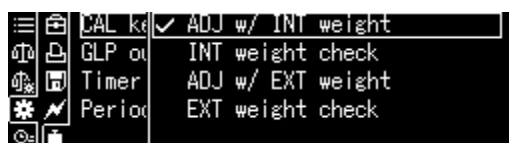

Select Settings with the help of the navigation keys and confirm using the **OK**-key.

Use the **ON/OFF** button to return into weighing mode



8.3.2 Adjustment with internal weight

Ensure that the **CAL**-key is allocated with the <Internal adjustment> function, see chap. 8.3.1.

Press **CAL** key, adjustment is started.

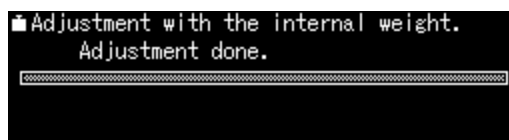
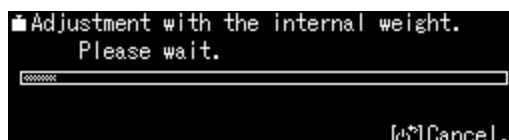

After successful adjustment the balance automatically returns to weighing mode. In case of an adjustment error (e.g. objects on the weighing plate) the display will show an error message, repeat adjustment.

8.3.3 Adjustment test with internal weight

During adjustment tests the balance automatically compares the saved value of the adjustment weight with the actual value. This is only a check, i.e. no values are changed.

Ensure that the **CAL**-key is allocated with the <Internal adjustment test> function, see chap. 8.3.1.

To start the test, press the **CAL**-key.

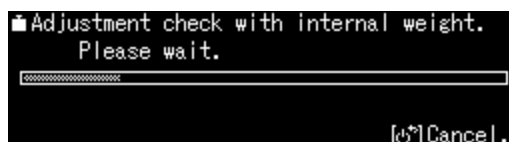

The difference to the previous adjustment will be displayed.

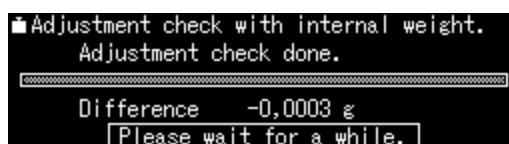

8.3.4 Adjustment with external weight

Ensure that the **CAL**-key is allocated with the <External adjustment> function, see chap. 8.3.1.

Press the **CAL**-key and the weight value for the adjustment weight will be flashing on the display. (To change the weight value, press the **MENU** button and follow the instructions on the display*).

Put the required adjustment weight carefully in the center of the weighing plate. Close wind screen doors completely. Wait until the request for removing the adjustment weight is displayed.

Take away adjustment weight.

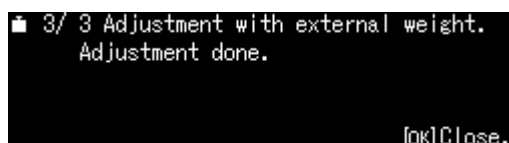
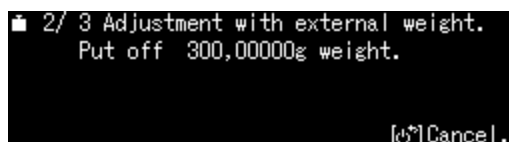
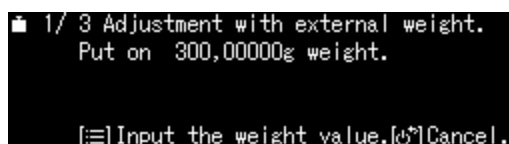

*The adjustment weight to be used depends on the capacity of the scale. Carry out adjustment as near as possible to the balance's maximum weight (recommended adjustment weight see chap. 1). Weights of different nominal values may be used for adjustment but are not optimal for technical measuring. Info about test weights can be found on the Internet at: <http://www.kern-sohn.com>

8.3.5 Adjustment test with external weight

Ensure that the **CAL**-key is assigned to the <External Weight Test> function, see chap. 8.3.1.

Press the **CAL**-key and the weight value for the adjustment weight will be flashing on the display. (To change the weight value, press the **MENU** button and follow the instructions on the display).

Put the required adjustment weight carefully in the center of the weighing plate. Close wind screen doors completely. Wait until the request for removing the adjustment weight is displayed.

The difference to the previous adjustment will be displayed.

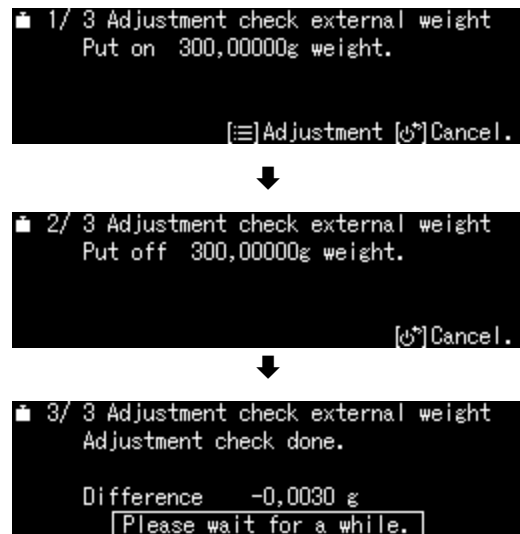

8.4 Adjustment log

If an optional printer is connected and the GLP function enabled, this will be followed by automatic log output after every adjustment.

Printout example (KERN YKB-01N):

CAL –INTERNAL		Mode of adjustment
KERN & Sohn GmbH		Company
TYPE	ABP 300-4M	Model
SN	D319300002	Serial no.
BALID	1234	Balance identification no.
DATE	2018 Aug. 17	Date
TIME	09.14.21	Time
REF	200.00000 g	Used adjustment weight
BFR	200.00000 g	Before adjustment
AFT	200.00000 g	After adjustment
-COMPLETE		
-SIGNATURE-		prepared by

+ For enabling / defining GLP-function see chap. 15.8.3

8.5 Regular inspections

The ABP series supports regular inspection of your scale. This function may be used to check repeatability, off-center stress (off-center load errors) and linearity. The instructions on the display support the implementation of individual steps.

Parameter setting:

Call up menu:

Press and hold the **CAL**-key for approx. 3 sec until the <CAL key setting> menu appears.

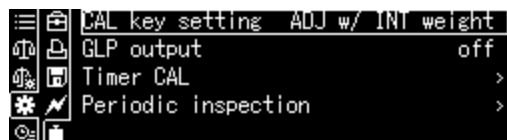

Use the navigation keys to select <Periodic inspection> and confirm using the **OK**-key.

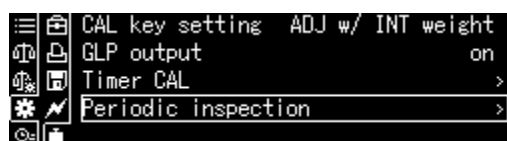

1. Settings Repeatability

<1. Select <Repeatability inspection> and confirm using the **OK**-key.



Select desired setting and confirm using the **OK**-key.

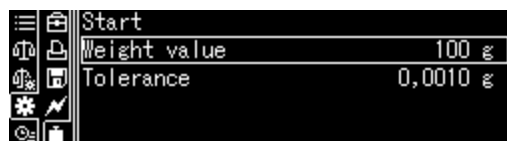

To enter the weight value for the test weight, select <Weight value> and confirm using the **OK**-key.

Use the navigation keys to enter the value and confirm using the **OK**-key.

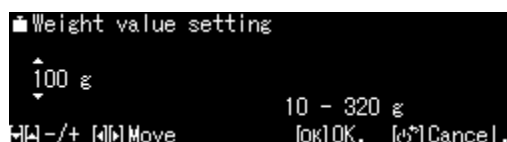

Repeat these operating steps to set all other settings for <Tolerance> / <Number of repetitions>.

Return to menu by .

2. Settings off-center load

Repeat these operating steps for Settings as shown for "Item 1 Repeatability".



3. Settings linearization

Repeat these operating steps for Settings as shown for "Item 1 Repeatability".

Performing test sequence:

Call up menu:

Press and hold the **CAL**-key for approx. 3 sec, the <CAL key setting> setting menu will appear.

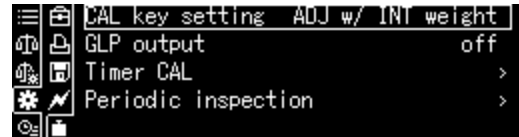

Use the navigation keys to select < Periodic inspection > and confirm using the **OK**-key.

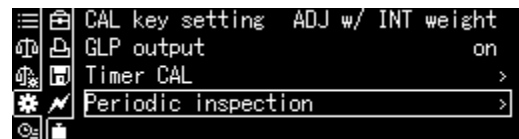

Select desired test and confirm using the **OK**-key.



Select <Start> and confirm using the **OK**-key.
Follow the instructions on the display.

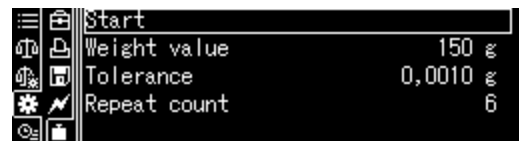

9 Verification

General:

According to EU directive 2014/23/EU balances must be officially verified if they are used as follows (legally controlled area):

- a) For commercial transactions if the price of goods is determined by weighing.
- b) For the production of medicines in pharmacies as well as for analyses in the medical and pharmaceutical laboratory.
- c) For official purposes
- d) For manufacturing final packages

In cases of doubt, please contact your local trade in standard.

Balances in the legally controlled area (-> verified balances) must keep the error limits in the verification validity period – normally they are the double of the verification error limits.

When this verification validity period expires, a re-verification must be carried out. Should be necessary an adjustment of the balance to keep the verification error limits to satisfy the re-verification requirements, this is not deemed a warranty case.

Verification notes:

An EU type approval exists for balances described in their technical data as verifiable. If the balance is used where obligation to verify exists as described above, it must be verified and re-verified at regular intervals.

Re-verification of a balance is carried out according to the respective national regulations. The validity for verification of balances in Germany is e.g. 2 years.

The legal regulation of the country where the balance is used must be observed!



Verification of the balance is invalid without the seal.

The seal marks attached on verified balances point out that the balance may only be opened and serviced by trained and authorized specialist staff. If the seal mark is destroyed, verification loses its validity. Please observe all national laws and legal regulations. In Germany a re-verification will be necessary.

Position of the official seals



10 Basic Operation

10.1 Activate standard weighing mode

Status balance	Action
The balance is now in stand-by mode	Press the ON/OFF button.
Scale is in a different operating mode	Press F -key
	or 
Balance is in menu	Press the ON/OFF key
After numeric input	Repeatedly press the ON/OFF key.

10.2 Simple weighing



A warm-up time is required for stabilization (see chap. 1).

- ⇒ Wait for zero display, reset to zero using **TARE**.
- ⇒ Place the goods to be weighed and close the wind screen doors
- ⇒ Wait until the stability display appears (→).
- ⇒ Read weighing result.

When an optional printer is connected, the weighing value can be edited.

Print-out example with enabled GLP function (ABP-Series only) (see chap. 15.8.3):

KERN & Sohn GmbH	Company
TYPE ABP 300-4M	Model
SN D319300002	Serial no.
BALID 1234	Balance identification no. (s. chap. 13.3)
DATE 2018 Aug. 17	Date
TIME 09.14.21	Time
19.999[8] g	Weighing value
-SIGNATURE-	prepared by

Print-out example with disabled GLP function (see chap. 15.8.3):

19.999[8] g	Weighing value
-------------	----------------

10.3 Taring

The dead weight of any weighing container may be tared away by pressing a button, so that the following weighing procedures show the net weight of the goods to be weighed.

- ⇒ Put vessel of goods to be weighed on weighing plate and close the wind screen doors.
- ⇒ Wait until the stability display appears (→), then press **TARE**. The weight of the container is now internally saved.
- ⇒ Weigh the goods to be weighed and close the wind screen doors.
- ⇒ Wait until the stability display appears (→).
- ⇒ Read net weight.

Note:



- The balance is able to only store one taring value at a time.
- When the balance is unloaded the saved taring value is displayed with negative sign.
- To delete the stored tare value, remove load from weighing pan and press **TARE**.
- The taring process can be repeated any number of times. The limit is reached when the whole weighing range is exhausted.

10.4 Functions of the ABP-A series (Standard weighing mode)

10.4.1 Measuring with the automatic door function (Position memory function)

This function opens and closes the glass doors (top, left, right) automatically when the buttons „open and close door“ are actuated.

The glass doors to be opened and to be closed and the percentage by which the glass doors shall open, can be adapted according to the application.

When pressing the keys "Open & close door" with open door, the balance memorizes this door position and closes the door.

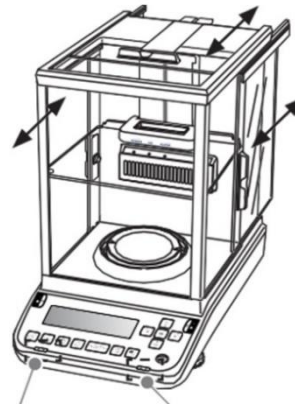

Door opening and closing button
(left/right)



Make sure that the stopper knobs are attached to the glass doors (top, left, right) before switching-on the device.
Otherwise the glass doors could be damaged.

Configuration of the automatic door function (Position memory function)

One individual button to open and to close the door can be configured in a way that it will open up to three doors at the same time (top, left, right) to their set positions.

Specific examples for application

The door opening and closing button (left) shall save the opening of the glass doors (left/right) on half height.

Configure as follows:

(1) Open the glass doors (left/right) manually till to half position.

(2) Now press the key to open and to close the door (left).

(3) The glass doors (left/right) are automatically closed. The process is now registered.

(4) By pressing the door opening and closing button (left) the glass doors (left/right) now are opened automatically till to half position. If you press again the door opening and closing button (left), after by that having opened the glass doors (left/right), the glass doors (left/right) now are closed automatically.

To select another setting, repeat the steps (1) (2) (3).

The settings of the buttons to open and to close the door are reset when the balance is switched off.

Manual actuation of the trigger (manual start)

By slight pressure on the handles of the glass doors in opening direction, the process is started and the respective doors are completely opened. By slight pulling on the handles in closing direction, the doors will close automatically.

The function of the manual trigger (manual start) can be disabled.





see chap. 13.9.

10.4.2 Measuring with the IR sensor (touchless function)

The same process can be repeated with the IR sensors, without pressing a button.

The following four functions can be carried out with the IR sensors, without pressing a button.

see chap. 13.10.1.

Button	Designation	Function
	Buttons for opening and closing doors	Opening and closing glass doors which have been configured by the position memory function.
	[PRINT]	Data output to external device (weighing mode)
	[TARE]	Taring Zeroing
	[Ionizer]	Starting the ionizer (ABP series Factory Option)

The button to open and to close the door (left) can only be assigned to the left IR sensor while the button to open and to close the door (right) left can only be assigned to the right IR sensor.

The settings of the IR sensor are not changed, even if the current supply is switched off. The position memory function will be reset.

Using the IR sensor

If you run your hand over the right or the left sensor, the blue LED for the corresponding sensor will light up.

The blue LED lights up for the corresponding sensor and continues lighting, whilst the sensor is actively recorded.

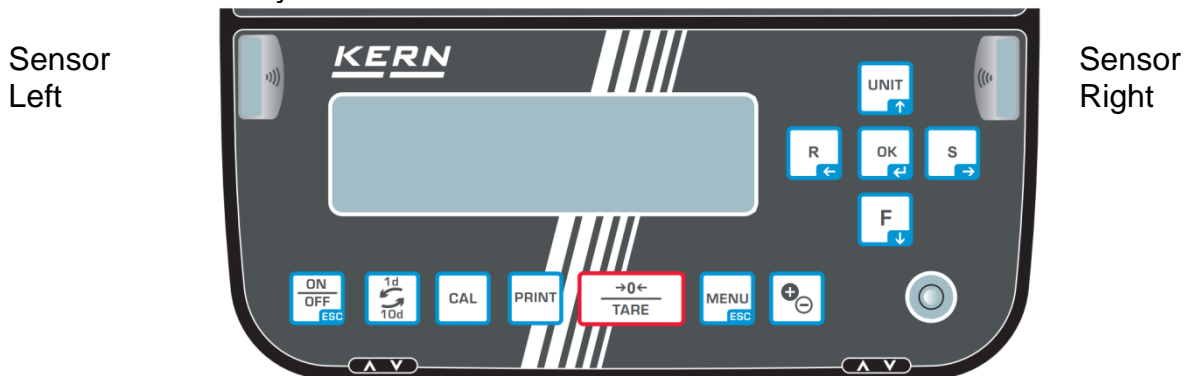

The IR sensors have two modes and the use of the IR sensors will differ when the mode is changed, see chap. 13.10.1

The IR sensors cannot be used, when the menu screen or when the standby mode is displayed. Also during calibration or in another situation than in the display of weight values. Return to the display of the weight value in order to use the touchless sensors.

10.5 Adjustable internal windshield (only at ABP-A Semi-Micro-Models)

By using the adjustable windshield plate, the volume of the weighing space is reduced and makes it thus more resistant against influence by the outside air. Due to the positioning depending on the sample/container to be weighed, it allows a reduction of the convection air current for a quicker measurement, see chap. 10.5.

Changing the position of the adjustable windshield

The adjustable windscreen plate can be moved upwards and downwards, by holding the handle fast and pulling the lever.

The lever is pulled back and the adjustable windshield plate is locked when the handle is released.

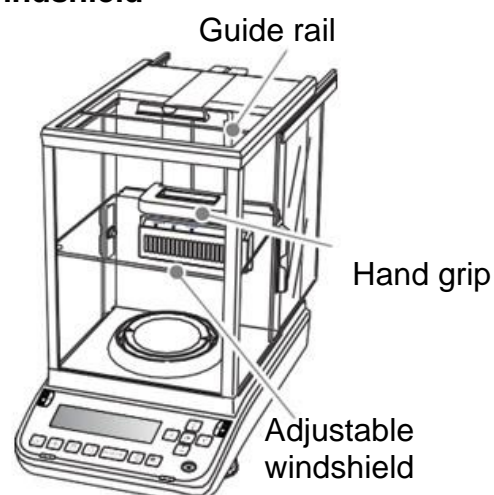

10.6 Underfloor weighing

Objects unsuitable for placing on the weighing scale due to size or shape may be weighed with the help of the flush-mounted platform.

Proceed as follows:

- ⇒ Switch off the balance.
- ⇒ Open closing cover (1) at the balance bottom.
- ⇒ Place weighing balance over an opening.
- ⇒ Attach weighed good to the hook and carry out weighing procedure.

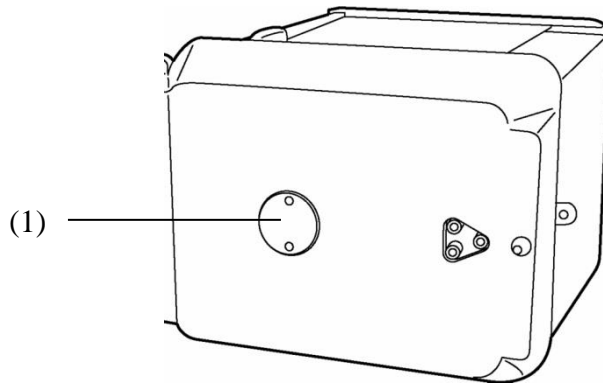

Fig.1: Underfloor weighing device



CAUTION

- Always ensure that all suspended objects are stable enough to hold the desired goods to be weighed safely (danger of breaking).
- Never suspend loads that exceed the stated maximum load (max) (danger of breaking)

Always ensure that there are no persons, animals or objects that might be damaged underneath the load.



NOTICE

After completing the underfloor weighing, the opening on the bottom of the balance must always be closed (dust protection).

10.7 Switch off the balance

- ⇒ Press the **ON/OFF** button. The balance is in standby mode, that means that the balance is now in state ready-for-operation. Immediately after switching-on it is ready for operation (press any key) without warm-up time.
- ⇒ To switch-off the balance completely, separate balance from power supply.



-  When you see messages such as [**Communication**] do not disconnect scale from power supply.

10.8 Switch-over weighing unit

To return the display to the units previously enabled in the menu press the **UNIT**-key, see chap. 12.7.



-  When switching-on the balance, the unit in which the balance has been switched off, will be displayed.

10.9 Change readability (1D/10D) (not available for verified models)

1d Display

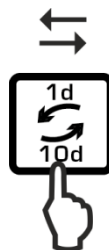

10d Display



10.10 Display Tare / Net / Gross

In weighing mode press **MENU** button.

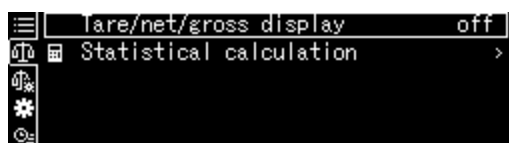

Select <Tare/Net/Gross display> and confirm using the **OK**-key.

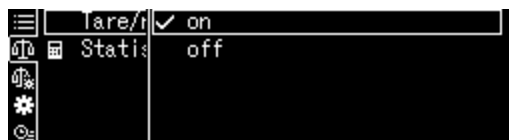

Select <on> setting and confirm using the **OK**-key.

Display for setting <On>



Display for setting <Off>



10.11 Display decimal dot as point or comma

Select <System settings> and confirm using the **OK**-key.



Select <Display decimal point> and confirm using the **OK**-key.



Select desired setting [Point] or [Comma] and confirm using the **OK**-key.

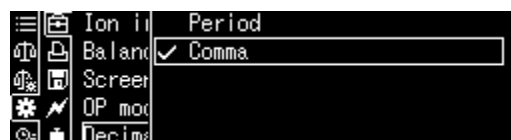













Use the **ON/OFF** button to return into weighing mode



11 Menu

11.1 Navigation in the menu

Call up menu	
Select menu block	<p>Use the navigation buttons to select the individual menu blocks one by one.</p> <p>Use the navigation key  to scroll down.</p> <p>Use the navigation key  to scroll up.</p>
Select menu item	<p>Confirm selected menu block by pressing . The first menu item of the selected menu block will be shown.</p> <p>Use the navigation buttons to select the individual menu items one by one.</p> <p>Use the navigation key  to scroll down.</p> <p>Use the navigation key  to scroll up.</p>
Select setting	<p>Confirm selected menu item with  and the current setting will be shown.</p>
Change settings	<p>Use the navigation keys to switch over into the available settings.</p> <p>Use the navigation key  to scroll down.</p> <p>Use the navigation key  to scroll up.</p>
Confirm setting	<p>Acknowledge with  or reject with </p>
Back to the previous menu	<p>Press </p>
Return to weighing mode	<p>Press </p>

Display examples:

General navigation:

i All selectable functions and settings may be accessed by navigating the arrow keys [↑, ↓, ←, →] and confirming by pressing the **OK**-key.

The framing will indicate the current selection.

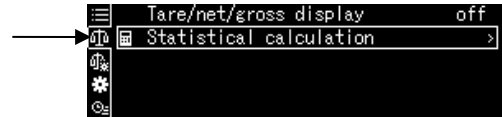

When the icon  is displayed you can press the **S**-key to access a submenu.

If a scroll bar is shown, further parameters may be displayed by using the navigation keys ↑, ↓.

Menu settings surrounded by square brackets are not available.

Press the **R**-key to return to the previous menu.

Numerical input, see chap. 3.2.1.

11.1.1 Standard weighing mode



The list of available settings will be displayed

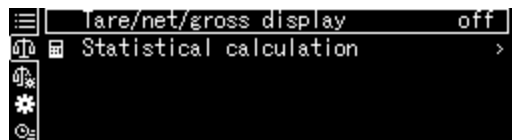

Change settings

1. Tare/net/gross display

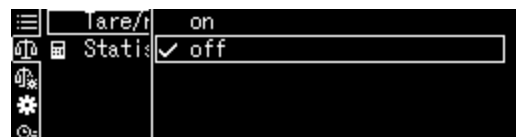
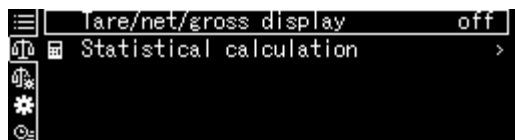

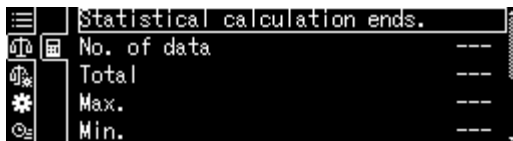
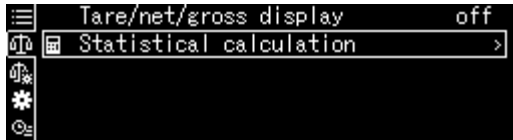
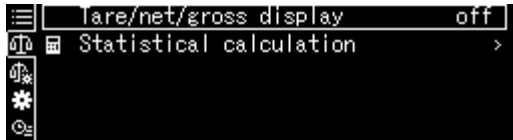

Use the navigation keys to select the desired settings ↑, ↓ and confirm using the **OK**-key.

2. Statistics



A submenu will be available by pressing 

if the icon  is displayed.

Use the navigation keys to select the desired setting ,  and confirm using the OK-key.

Return to menu by .

11.1.2 Weighing settings

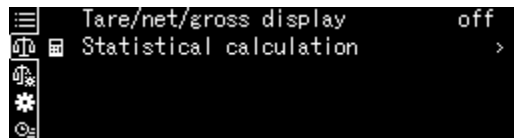
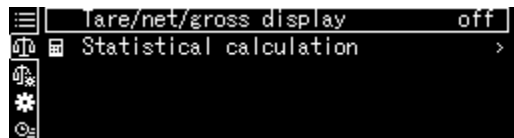

The list of available settings will be displayed.

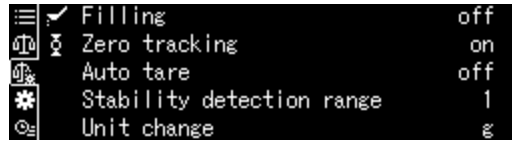

Confirm using the **OK**-key. The framing will indicate the current selection.

Select the desired settings using the **F**-key.

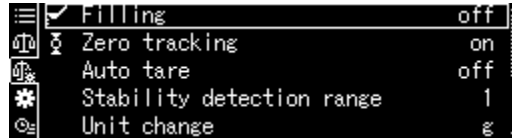

To change your selection, press the **OK**-key.

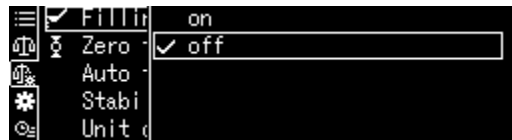

Use the navigation keys **↑**, **↓** to select the desired settings and confirm using the **OK**-key.

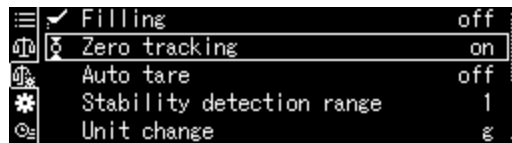

Press the **F**-key to select additional settings and make changes as described above.

11.1.3 System Settings

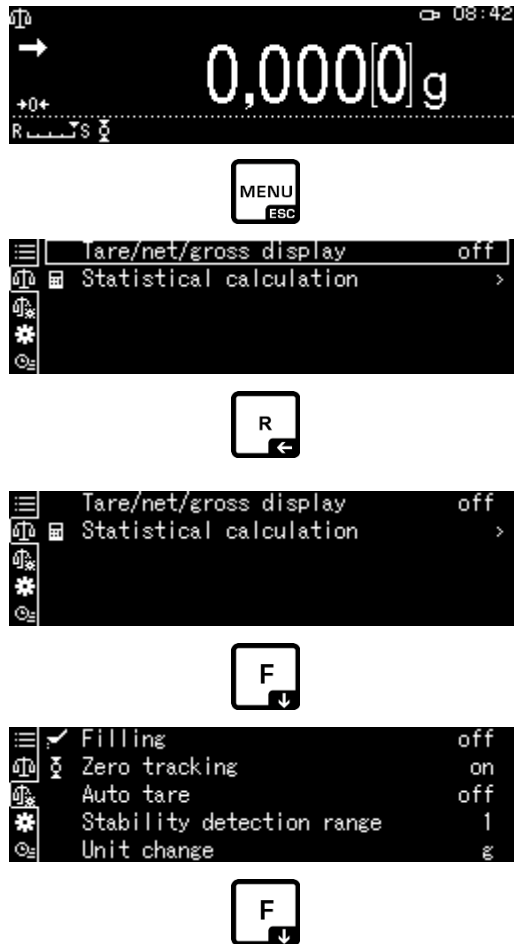

The list of available menu blocks will be displayed.

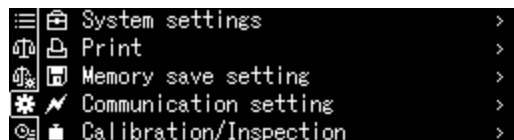

Confirm using the **OK**-key. The framing will indicate the current selection. Use the navigation keys **↑**, **↓** to select the desired menu block (such as system settings).



Confirm selection by pressing the **OK**-key.

The list of available settings will be displayed.

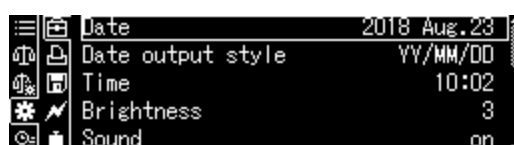

Use the navigation keys **↑**, **↓** to select the desired setting (such as brightness).



To change your selection, press the **OK**-key.

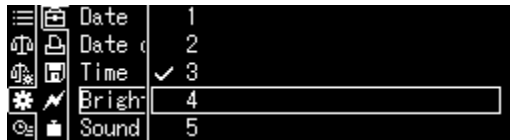

Use the navigation keys **↑**, **↓** to select the desired setting and confirm using the **OK**-key.



Press the F-key to select additional settings and make changes as described above.

11.1.4 Application settings

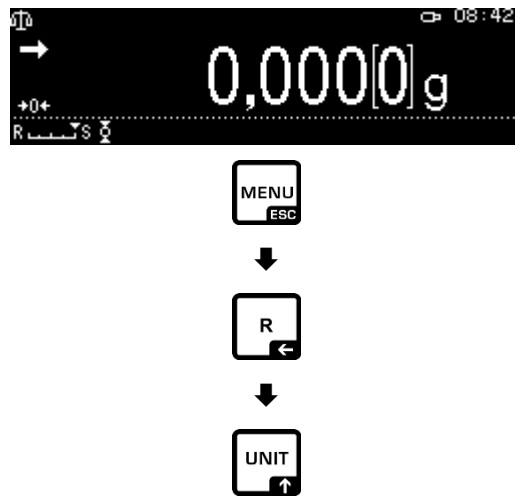

The available applications will be displayed.

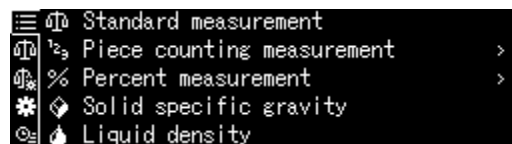

Press the **OK**-key and use the navigation keys **↑**, **↓** to select the desired application, such as part counting. The framing will indicate the current selection.

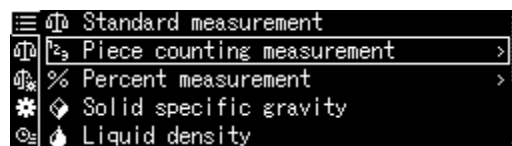

Confirm using the **OK**-key and the application specific settings will be displayed.



The application-specific settings are described in the respective chapters.

11.2 Menu overview



The menu overview is part of the scale's scope of delivery and supplied in the form of a separate document.

11.3 Resetting the menu

Using this function, you can reset all balance settings to factory default.

- i** • Factory settings are marked by a “*” in the menu oversight.
- If user management is enabled, menu resetting may only be made by an authorised user.

1. Call System Settings

⇒ see chap. 11.1.3.

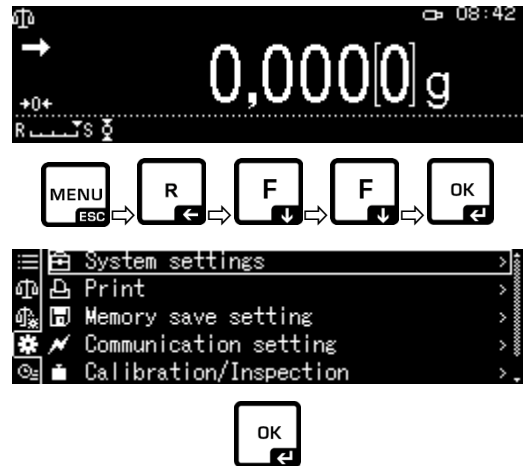

2. Enable/disable function

Use the navigation keys **↑**, **↓** to select <Menu reset> and confirm using the **OK**-key.

Password prompt will be displayed. Enter password and confirm using the **OK**-key (For “numeric input” see chap. 3.2.1).

Either

Enter user-defined password

or

Enter standard password [9999] (default setting)

Confirm query by pressing the **OK**-key

All user and application specific settings will be reset to default setting.

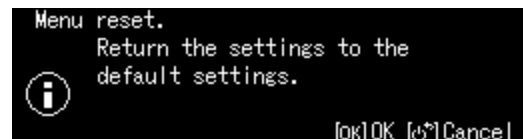
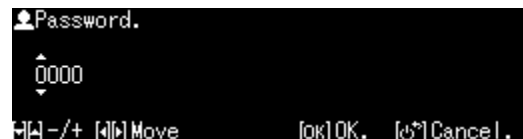

11.4 Menu Lock

The menu setting operations can be locked so that the settings cannot be inadvertently changed. This menu lock is set with the following procedure.

1. Call System Settings

⇒ see chap. 11.1.3.



2. Enable/disable function

Use the navigation keys **↑**, **↓** to select <Menu lock> and confirm using the **OK**-key. Password prompt will be displayed.

Enter password, see chap. 3.2.1 "Numeric input" and confirm using the **OK**-key.

Either

Enter user-defined password

or

Enter standard password [9999] (default setting)

Confirm query by pressing the **OK**-key

Use the navigation keys **↑**, **↓** to enable (on) / disable (off) the function and confirm using the **OK**-key.

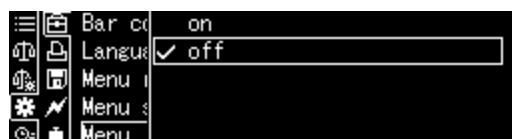
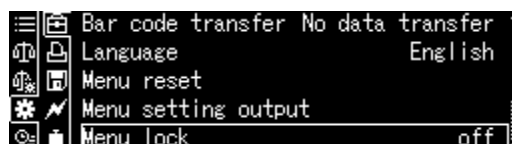

i



- The  icon will be displayed while the function is enabled.
- Weighing and adjustment can take place despite menu lock.
- Authorisation for performing this function may be allocated to any user.
- To disable the menu block, select Settings [off].

11.5 Log menu settings

When an optional printer is connected, a list of the current menu settings can be printed out.

1. Call System Settings

⇒ see chap. 11.1.3.

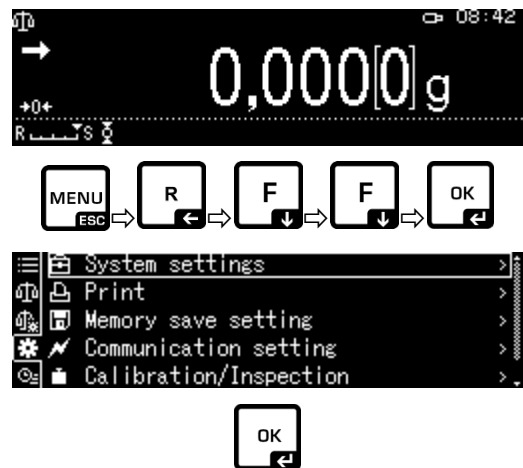

2. Activate function

Use the navigation keys **↑**, **↓** to select <Edit Menu settings> and confirm using the **OK**-key.



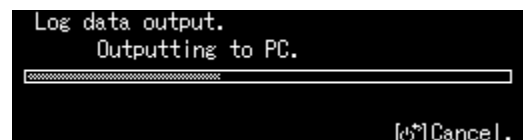
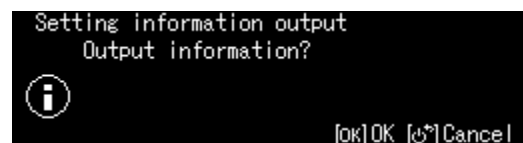

Confirm request by pressing the **OK**-key and printing will start.

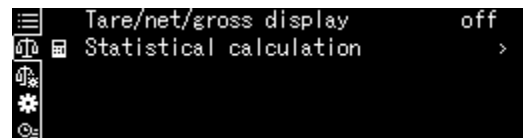

11.6 Menu history

This function is applied to display the last 10 menu steps.



Use the navigation keys \uparrow , \downarrow to select
<  > and the last 10 menu steps will be displayed.

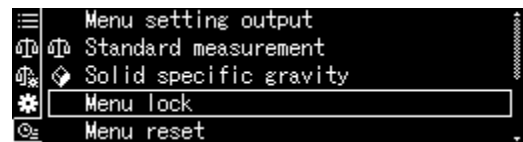

12 Description of individual functions

12.1 Zero setting and tare function

Selectable functions:

1. Zero tracking

+ see chap. 12.2.

Description

This function is used to correct automatically small weight variations which appear directly after switching-on.



In the event that small quantities are removed or added to the material to be weighed, incorrect weighing results can be displayed due to the "stability compensation". (e.g. slow flow of liquids from a container placed on the balance, evaporating processes).

When apportioning involves small variations of weight, it is advisable to switch off this function.

2. Auto tare function see chap. 12.3

After data output an automatic taring is carried out

12.2 Zero tracking



The icon  will be displayed while the zero tracking function is enabled.

1. Call function

⇒ see chap. 11.1.2.

or

Press and hold the **TARE**-key for a long time

Use the navigation keys to select **↑**, **↓** <Zero tracking> and confirm using the **OK**-key.

2. Enable/disable function

Use the navigation keys **↑**, **↓** to enable (on) / disable (off) the function and confirm using the **OK**-key.

3. Back to weighing mode, press **ON/OFF** button.

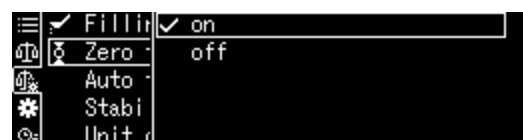
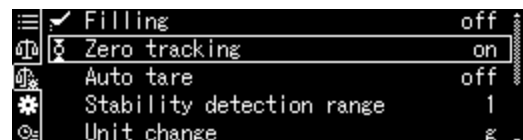
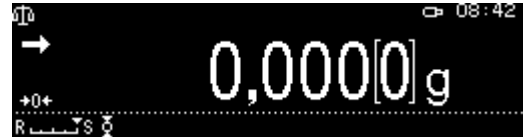

12.3 Auto Tare function

1. Call function

⇒ see chap. 11.1.2.

or

Press and hold the **TARE**-key for a long time

Use the navigation keys **↑**, **↓** to select <Auto tare> and confirm using the **OK**-key.

2. Enable/disable function

Use the navigation keys **↑**, **↓** to enable (on) / disable (off) the function and confirm using the **OK**-key.

3. Return to weighing mode

Press the **ON/OFF** key

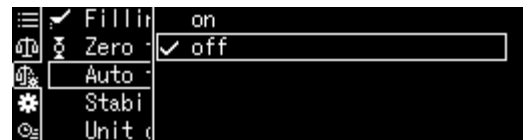
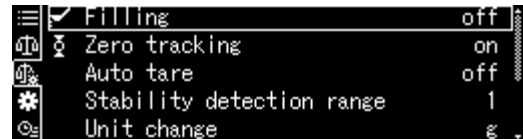
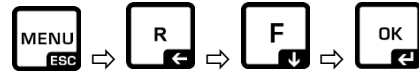

12.4 Settings for Stability and Response

Exists the possibility to tune the stability of the display and the degree of response of the balance to the requirements of certain applications or the environmental conditions.

Most measurements may be carried out by using default settings. In standard weighing mode, stability and response have the same priority. For certain applications such as e.g. dosage do use the dosing mode. In dosing mode the response degree has the higher priority.

Beside the selection standard / dosing mode the stability of the display and the response degree of the balance can additionally adapted in the menu.

Please note that in general slowing down response times result in higher stability of the set data handling, while speeding up response times have an influence on the stability deterioration.

12.4.1 Stability and response settings via „Smart Setting display“ (without invoking menu)

If there is a change in ambient conditions the responding qualities or the stability of the scale may be optimized – even during weighing – by simply pressing the key.



⇒ In weighing mode press  for Response Settings or  for Stability Settings.

Priority on response

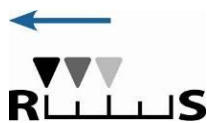

RLL



Smart setting display

Priority on stability



LLS



Operation

Every time the key is pressed, the priority for the response will be increased. The icon ▼ will be moving in the direction of <R>.

Every time the key is pressed the priority for the stability will be increased. The icon ▼ will be moving in the direction of <S>.

12.5 Dosing

Use this function if you wish to increase display speed, e.g. during apportioning. However, please note that the balance is very susceptible to ambience conditions.



The  icon will be displayed while the function is enabled.

1. Call function

⇒ see chap. 11.1.2.



<Filling> Confirm using the **OK**-key.

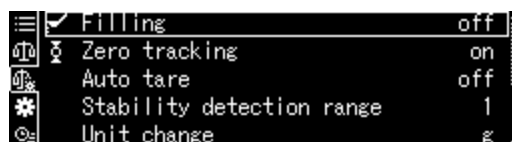

2. Enable/disable function

Use the navigation keys **↑**, **↓** to enable (on) / disable (off) the function and confirm using the **OK**-key.

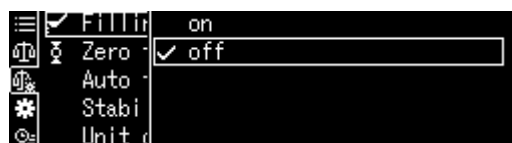

3. Return to weighing mode

Press the **ON/OFF** key

12.6 Standstill width

If the stability display lights up (→), the weighing result will be stable within the range indicated by the standstill width.

Set range for stability determination:

1. Call function

⇒ see chap. 11.1.2.

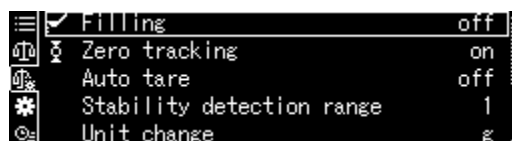

Use the navigation keys ↑, ↓ to select <Stability detection range> and confirm using the **OK**-key.

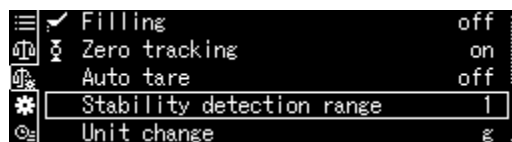

2. Set range for stability determination

Use the navigation keys ↑, ↓ to select setting and confirm using the **OK**-key.

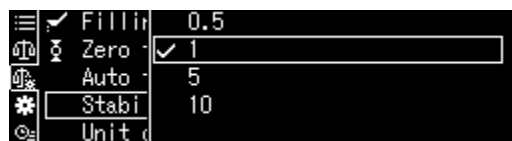

0.5d Stability display (→) very quiet environment



1000d Stability display (→) busy environment

3. Return to weighing mode

Press the **ON/OFF** key

12.7 Weighing Units

This function is used to define which weighing units you wish to apply. By pressing the **UNIT** key, the display can be switched over to the units enabled before in the menu.

Scales with type approval allow you to change to the following units:

[g] → [mg] → [ct]

1. Call function

In weighing mode press and hold the **UNIT**-key for approx. 3 sec until the <Unit setting> menu is displayed.

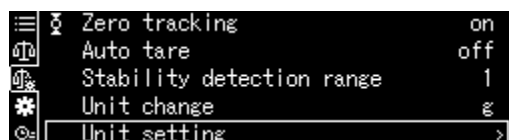

Confirm using the **OK**-key and the available units will be displayed.



Use the navigation keys to **↑**, **↓** select the unit and confirm using the **OK**-key.



2. Enable/disable units

Use the navigation keys **↑**, **↓** to enable (on) / disable (off) the function and confirm using the **OK**-key.

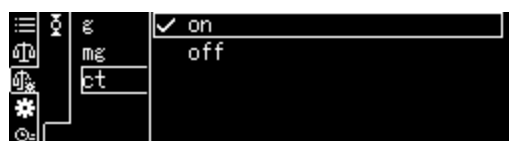

3. Return to weighing mode

Press the **ON/OFF** key

12.8 User administration log-in function

The scale has a user administration where individual access rights for administrator and user levels may be defined. The input of a user name and password is required for access.

The administrator can use all the functions and has all rights. Only the administrator is authorized to create new user profiles and to grant access rights.

A user on the other hand may not have access to all functions. He/she has limited rights that are defined in the user profile. The maximum of users is limited to 10.

a) Enable/disable function

Login function [off]	Login function [on]
All users have administrator rights and full access (default setting).	There is only one administrator and maximal 10 users.

1. Call System Settings

⇒ see chap. 11.1.3.

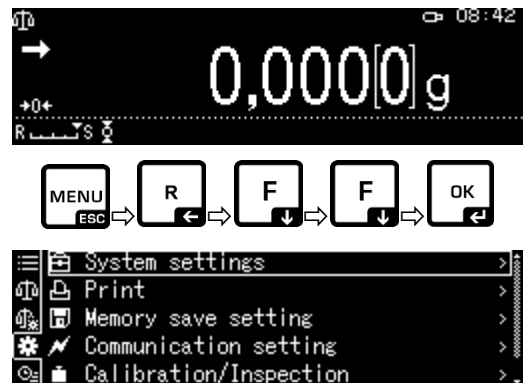

Use the navigation keys to select **↑**, **↓** <User setting > and confirm using the **OK**-key.

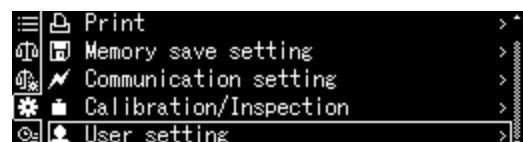

2. Enable/disable function

Use the navigation keys **↑**, **↓** to enable (on) / disable (off) the function and confirm using the **OK**-key.

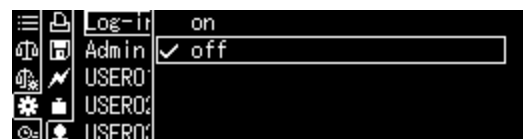
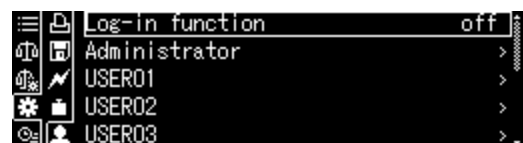

Weighing balance returns to menu.

From this point onwards you will be logged-in as administrator and authorized to change settings.

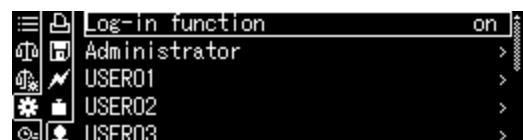

b) Creating a user profile

- i** Only the administrator may create new user profiles and grant access rights.
A user profile may only be changed by the administrator.

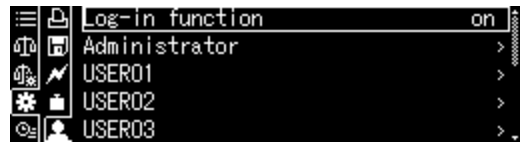

1. Select administrator or user

Use the navigation keys **↑**, **↓** to select Administrator or User <Administrator or User 01 - 10> and confirm using the **OK**-key.

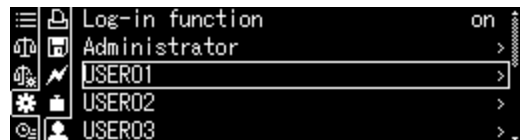

2. Define user selection to be displayed on log-in

Use the navigation keys **↑**, **↓** to select <User ID number> and confirm using the **OK**-key.



Use the navigation keys **↑**, **↓** to select <Valid> or <Invalid> and confirm using the **OK**-key.

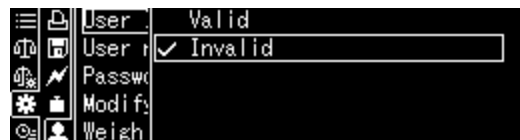

When selecting <Valid> continue with input as described in the next step.

When selecting <Invalid> use the **ON/OFF**-key to return to weighing mode.



3. Change user name

Use the navigation keys **↑**, **↓** to select <User name> and confirm using the **OK**-key.



Enter desired user name (for numeric input, see chap. 3.2.1)

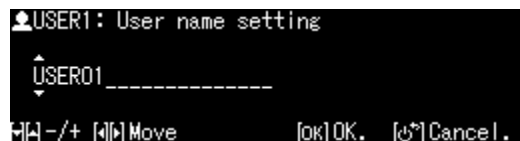

Confirm selection by pressing the **OK**-key.

Weighing balance returns to menu.

Here you may change settings as described below.

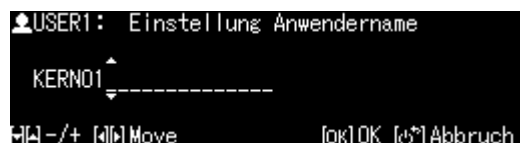

c) Define password

Different passwords are required according to user or administrator.

Type	Administrator password	User Password
Default setting for password	9999	0000
Log-in	Administrator ID	User ID
Access rights	All functions and rights	Limited rights defined in user profile. No password will be required if default setting [0000] is used.

Select user and confirm using the **OK**-key.

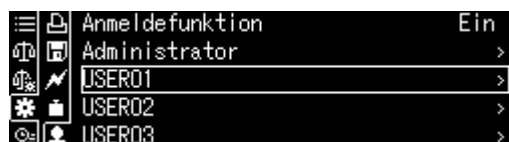

Use the navigation keys **↑**, **↓** to select <Password> and confirm using the **OK**-key.

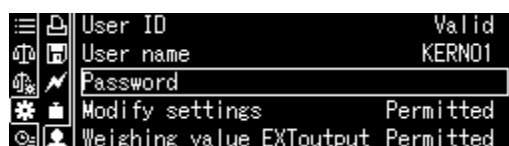

Enter password
(For numeric input see chap. 3.2.1)

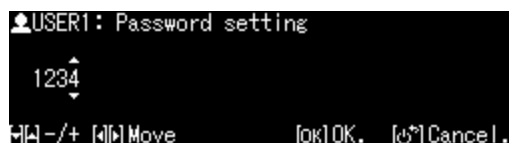

Confirm selection by pressing the **OK**-key.

Weighing balance returns to menu.

Here you may change settings as described below.



d) Granting user rights

The administrator defines which of the following activities may be performed by the user.

<Change settings>	Make settings in menu
<Output weighing value>	Data output to external devices
<Make use of USB>	Access to USB storage space
<Adjustment>	Change adjustment settings
<Test>	Carry out regular inspection check

Use the navigation keys **↑**, **↓** to select the activity such as <Modify setting>, to which access rights are to be granted or refused. Confirm selection by pressing the **OK**-key.



Use the navigation keys **↑**, **↓** to select the desired settings and confirm using the **OK**-key.

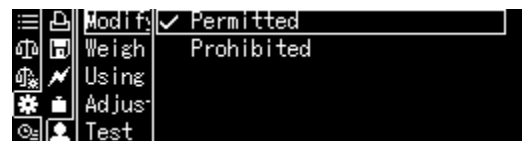

Weighing balance returns to menu.



Use the navigation keys **↑**, **↓** to select the next menu item such as <Weighing value output> and change settings as described above.

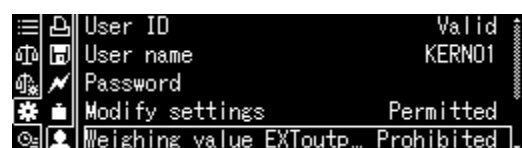

Repeat this sequence of operations for all five menu items.

Return to weighing mode:

Press the **ON/OFF** key

e) Change user name

Use the navigation keys **↑**, **↓** to select <User name> and confirm using the **OK**-key.



Enter desired user name (For numeric entry see chap. 3.2.1)

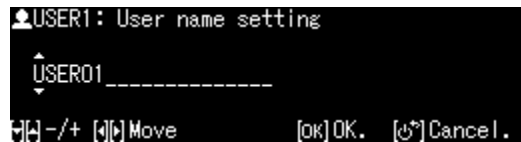

Confirm selection by pressing the **OK**-key.

Weighing balance returns to menu.

Here you may change settings as described below.

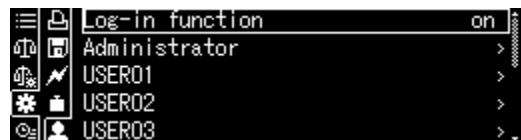

i The user name will be displayed on the top right of the display during operation and as long as the respective user profile is enabled.

f) Login

When the log-in function is enabled, the list of users will be displayed on log-in.



Use the navigation keys \uparrow , \downarrow to select User and confirm using the **OK**-key.

Password prompt will be displayed.

Enter password and confirm using the **OK**-key (For numeric entry see chap. 3.2.1).



i When a user logs in using the standard password [0000] no password query will be made.

The display will change into operating mode, the selected user will be enabled and will be shown at the top of the display.



- i**
- Apart from administrator or user it is also possible to log-in as "Guest".
 - A logged-in guest may merely perform weighing.

Sequence of operations:

Press the **ON/OFF**-key when list of users is displayed



The display will then change to operating mode, the selected user <GUEST> will be enabled and shown on the top of the display.



13 Balance settings

13.1 Screen saver

While this function is enabled the balance display will automatically turn dark change after a defined time without a change in load or conditions. You can turn off the function (ABP series only) or define a time after which the balance display turn dark. To restart press any key.

For calling system settings see chap. 11.1.3

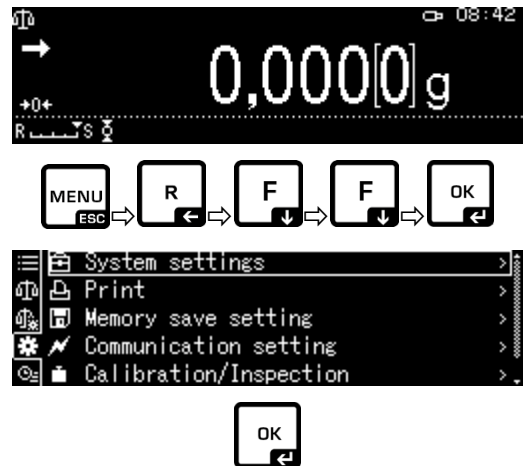

Use the navigation keys to select **↑**, **↓** <Screen saver> and confirm using the **OK**-key.

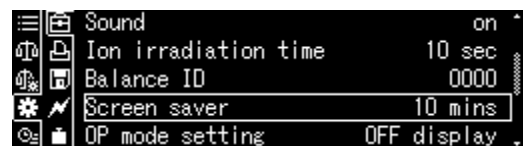

Use the navigation keys **↑**, **↓** to select switch off time and confirm using the **OK**-key.

Options: off, 5, 10, 15, 20, 30 min. (off is ABP series only)

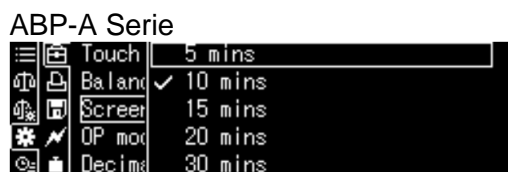

Use the **ON/OFF** button to return into weighing mode

13.2 Display settings in operating mode

For calling system settings see chap. 11.1.3

Use the navigation keys **↑**, **↓** to select <Operating modes display> and confirm using the **OK**-key.

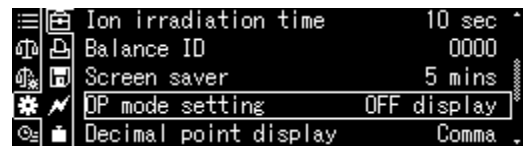

Use the navigation keys **↑**, **↓** to select the desired setting and confirm using the **OK**-key.

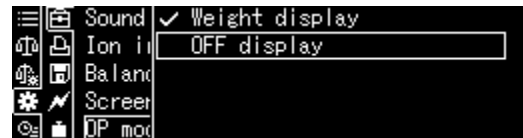

Use the **ON/OFF** button to return into weighing mode

13.3 Balance identification no.

This setting is for the balance ID number that is output along with the adjustment report.

For calling system settings see chap. 11.1.3

Use the navigation keys **↑**, **↓** to select <Balance ID number> and confirm using the **OK**-key.

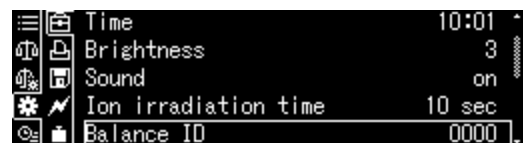

Use the navigation keys **↑**, **↓** to enter the name (max. 16 characters) and confirm using the **OK**-key.



Numerical input, see chap. 3.2.1.

Use the **ON/OFF** button to return into weighing mode

13.4 Entering date and time

For calling system settings see chap. 11.1.3

Use the navigation keys **↑**, **↓** to select <Date> or <Time> and confirm using the **OK**-key.



Use the navigation keys **↑**, **↓** to enter date or time and confirm using the **OK**-key.



Numerical input, see chap. 3.2.1.

Use the **ON/OFF** button to return into weighing mode

13.5 Date format

For calling system settings see chap. 11.1.3

Use the navigation keys **↑**, **↓** to select <Date output style> and confirm using the **OK**-key.



Use the navigation keys **↑**, **↓** to set output format and confirm using the **OK**-key



YY/MM/DD	Year/ month/ day
MM/DD/YY	Month/Day/Year
DD/MM/YY	Day/Month/Year

Use the **ON/OFF** button to return into weighing mode

13.6 Brightness of display

For calling system settings see chap. 11.1.3

Use the navigation keys to select **↑**, **↓** <Brightness> and confirm using the **OK**-key.



Use the navigation keys **↑**, **↓** to set brightness and confirm using the **OK**-key

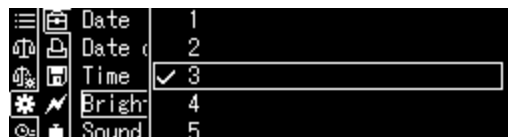

Use the **ON/OFF** button to return into weighing mode

13.7 Acoustic signal on pressing key and display of stability

For calling system settings see chap. 11.1.3

Use the navigation keys **↑**, **↓** to select <Acoustic signal> and confirm using the **OK**-key.



Use the navigation keys **↑**, **↓** to select setting [On] or [Off] and confirm using the **OK**-key

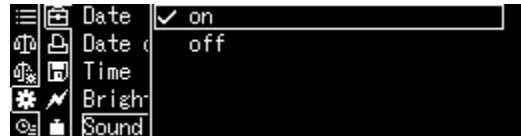

Use the **ON/OFF** button to return into weighing mode

13.8 User language

For calling system settings see chap. 11.1.3

Use the navigation keys **↑**, **↓** to select <Language> and confirm using the **OK**-key



Use the navigation keys **↑**, **↓** to select language and confirm using the **OK**-key

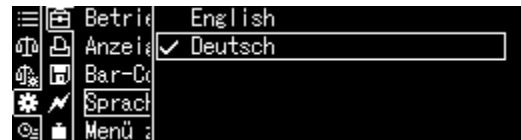

Use the **ON/OFF** button to return into weighing mode

13.9 Configuration of the manual door opener (only ABP-A series)

For calling system settings see chap. 11.1.3

Use the navigation keys **↑**, **↓** to select <Manual trigger> and confirm using the **OK**-key.

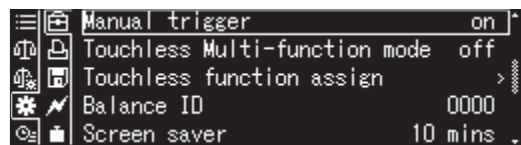

Use the navigation keys **↑**, **↓** to select setting [On] or [Off] and confirm using the **OK**-key

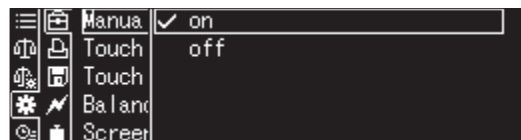





Use the **ON/OFF** button to return into weighing mode

13.10 Configuration methods of the IR sensors (only ABP-A series)

In this section we explain how you can switch-over the operating modes for the IR sensors and how you can assign functions to every IR sensor. After having configured the operating modes of the IR sensor, assign functions to the configured operating modes. The functions which can be assigned to the IR sensors, are listed in the following table.

If you don't use the IR sensors

You can configure the IR sensors in a manner that they are not enabled, even if you run a hand over the sensors. For this purpose don't assign any button function to the IR sensors.

Button	Designation	Function
	Buttons for opening and closing doors	Opening and closing glass doors which have been configured by the position memory function.
	[PRINT]	Data output to external device (weighing mode)
	[TARE]	Taring Zeroing
	[Ionizer]	Starting the ionizer (ABP series Factory option)

i The button to open and to close the door (left) can only be assigned to the left IR sensor while the button to open and to close the door (right) left can only be assigned to the right IR sensor. The settings of the IR sensor are not reset, even if the current supply is switched off and on again. The settings of the position memory function, however, are reset.

13.10.1 Switch-over the operating mode of the IR sensors

The ABP-A series has a multifunctional mode, in which four functions maximum can be assigned to the IR sensors. The operating modes of the IR sensors vary depending on whether this mode is turned on or turned off.

The multifunction mode is enabled as per standard.

IR sensor operation with enabled multifunction mode

When the multifunction mode is enabled, four functions maximum can be assigned to the IR sensors.

In the following you will see function examples of the IR sensors.

- Actuating the doors by running the hand over the left/right sensor
- Edit data by holding the hand above the IR sensor for approx. 2 seconds after having placed the sample and the weight value having been stabilized

By that way you can carry out a lot of procedures such as opening and closing the doors, taring and editing the weighing value without pressing any button of the operating field.

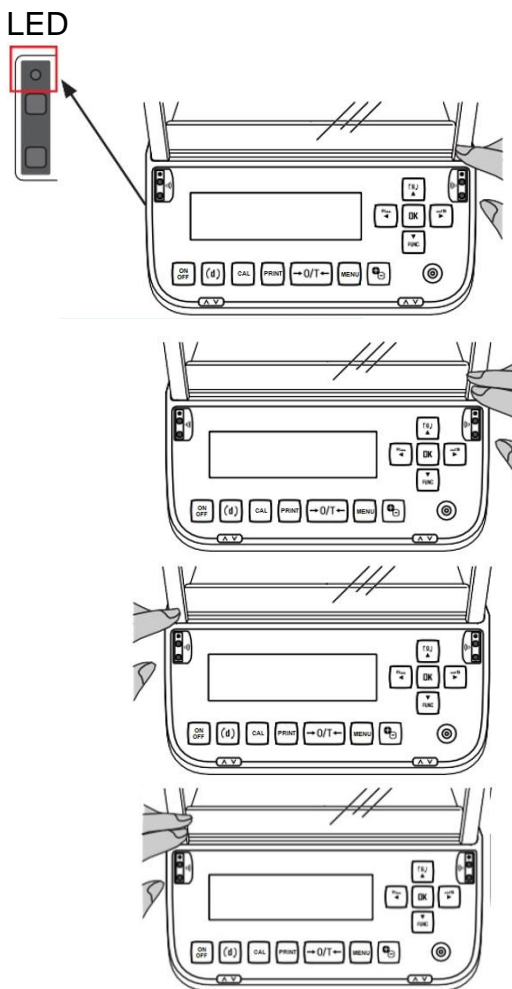

Actuate right IR sensor (short)
Run the hand over the sensor and remove it (when the LED lights up)

Actuate right IR sensor (long)
Hold the hand above the sensor, that the LED will light up for approx. 2 seconds.

Actuate left IR sensor (short)
Run the hand over the sensor and remove it (when the LED lights up)

Actuate left IR sensor (long)
Hold the hand above the sensor, that the LED will light up for approx. 2 seconds.

- i** In figure 1 & 3 you run your hand or your fingers over the IR sensor
→ The LED lights up
Then remove the hand or the fingers
→ The LED switches off and the function is enabled.

Touchless sensor operation with disabled multifunctional mode

Disabling the multifunctional mode permits a faster operation of the IR sensors than with enabled multifunctional mode. When the multifunctional mode is disabled, two functions may be assigned which are shown in the following illustration.

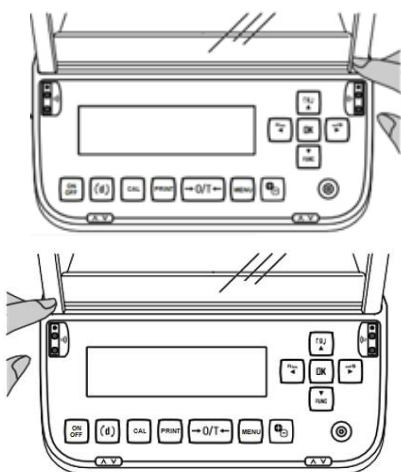

Right IR sensor (immediate)
Run your hand or your fingers over the sensor, the LED will light up

Left IR sensor (immediate)
Run your hand or your fingers over the sensor, the LED will light up

The function will be executed when you run your hand or your fingers over the touchless sensor and the LED is lighting up.

Procedure for the configuration of the multifunctional mode

For calling system settings see chap. 11.1.3

Use the navigation keys **↑**, **↓** to select <Touchless multifunctional mode> and confirm using the **OK**-key.

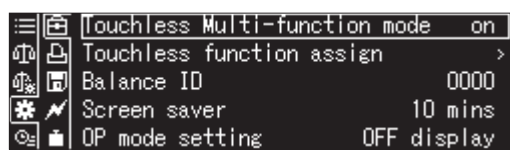

Use the navigation keys **↑**, **↓** to select setting [On] or [Off] and confirm using the **OK**-key

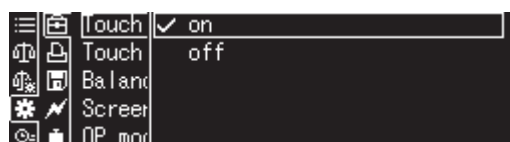

Use the **ON/OFF** button to return into weighing mode

Assignment configuration of touchless functions

For calling system settings see chap. 11.1.3

Use the navigation keys **↑**, **↓** to select <Touchless multifunction assignment> and confirm using the **OK**-key.

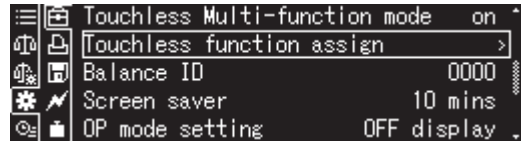

Use the navigation keys **↑**, **↓** to select <Right IR sensor (short)> and confirm using the **OK**-key.

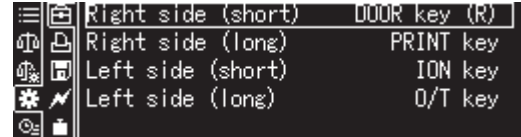

Use the navigation keys **↑**, **↓** to select the function which you want to assign to the right IR sensor (short)> and confirm using the **OK**-key.

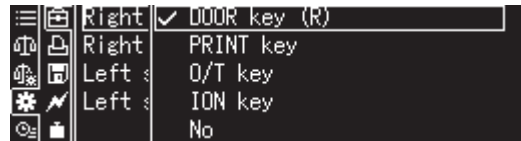

Use the **ON/OFF** button to return into weighing mode

Configure the right IR sensor (long), the left IR sensor (short) and the left IR sensor (long) on the same way.

Buttons	Function
Button open and close door (right)	Opening and closing the right door
Button to open and to close the door (left)	Opening and closing the left door
[Button [PRINTING]]	Data output to external device (weighing mode)
Button [O/T]	Taring / Setting to zero
[ION button]	Start ionizer
[None]	Disables the touchless sensors

The standard settings for the allocation of the touchless functions are as follows.

Multifunctional mode is enabled

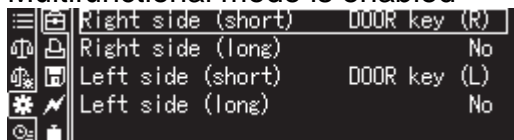

Multifunctional mode is disabled

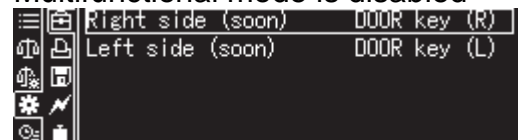

Checking the functions assigned to the touchless sensors (only when the multifunctional mode is enabled)

(1) Run your hand in load weighing mode over the right and the left IR sensors, to make the LEDs light up for approx. 2 seconds.

(2) The function allocation status is shown on the display field.

When the settings of the IR sensors are not correct, configure the settings anew.

(3) Run your hands over the right and the left IR sensor, to make the LEDs light up for approx. 2 seconds.

(4) Return to the load weighing mode.

The button [ON/OFF] can also be used for returning into the load weighing mode.

Move your hands simultaneously over the right and the left IR sensor, to make the LEDs light up for approx. 3 seconds.

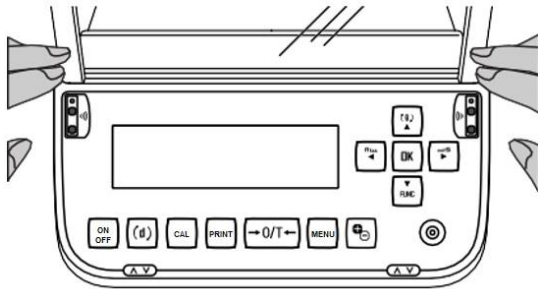









Call up the setting allocation menu by carrying out the operation shown on the left

☰	☒	Right side (short)	DOOR key (R)
☒	☒	Right side (long)	No
☒	☒	Left side (short)	DOOR key (L)
☒	☒	Left side (long)	No

14 Application Functions

Overview of available applications:

Symbol	Function	Combinable functions		
		Statistics	Check weighing	Minimum initial weight
	Parts counting	✓	✓	✓
	Percent determination	✓	✓	✓
	Density determination <Solid matter>	✓	✓	✓
	Density determination <Liquid>	✓	✓	✓
	Totalization	-	-	✓
	Free recipe composition	-	-	✓
	Recipe preparation	-	-	✓
	Buffer solution preparation	-	-	✓
	Sample preparation	-	-	✓



- The balance starts in the mode, in which it has been switched off.
- To switch-over between application and weighing mode press the **F**-button.

14.1 Parts counting

With parts counting you can either count parts into a container or remove parts from a container. To count a greater number of parts the average weight per part has to be determined with a small quantity (reference quantity). The larger the reference quantity, the higher the counting exactness. High reference must be selected for small parts or parts with considerably different sizes.

14.1.1 Settings

- + **Enable function and calculate single weight by weighing a known reference quantity.**

1. Selecting an application

⇒ see chap. 11.1.4.

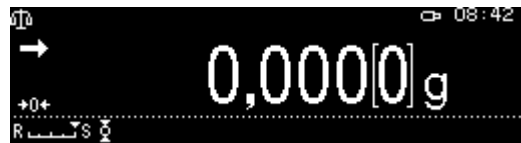

The available applications will be displayed.

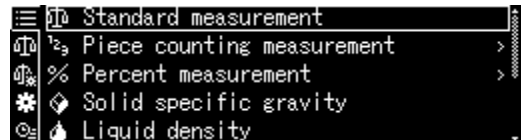

Use the navigation keys to select **↑ ↓** <Parts count>. The framing will indicate the current selection. Confirm using the **OK**-key and the application specific settings will be displayed.

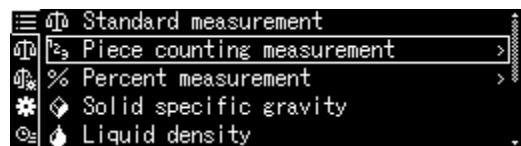

2. Storage location no. / name for initial input

Use the navigation keys **↑, ↓** to select a memory space and confirm using the **OK**-key.



For the **first input** the display for entering a memory name will appear.

Use the navigation keys **↑, ↓** to select a memory space and confirm using the **OK**-key.

If required, change name and confirm using the **OK**-key.

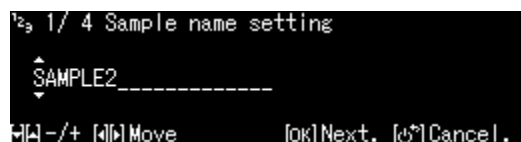

To **overwrite** a stored piece weight continue by referring to chap. 14.1.4

3. Set reference

Enter reference quantity and confirm using the **OK**-key.

```
2/ 4 Setting reference PCS
005 PCS
1 - 100 PCS
[-]/+ [j] Move [ok] Next. [c] Cancel.
```



Load the number of parts corresponding to the selected reference quantity. Wait until stability display has settled, then confirm using the **OK**-key.

```
3/ 4 Unit weight measurement
→ 20,000[1]g
R S g [ok] Meas. [c] Cancel.
```



The scale will calculate the average single weight and display the result. Confirm using the **OK**-key

```
4/ 4 Unit weight registered
Name TEST
Unit Weight. 4,0000200 g
Reference PCS 5 PCS
[ok] Close.
```

+ Enter single weight as numeric value

- ⇒ In counting mode, press **MENU**-key.
- ⇒ Use the navigation keys to select **↑**, **↓** <Single weight> and confirm using the **OK**-key.
- ⇒ Enter known single weight and confirm using the **OK**-key.

```
Sample name TEST
Reference PCS 25
Reference weight 99,9968 g
Unit weight 3,9998720 g
Display with load weight off
```



```
Unit weight setting
003,9998720 g
0,0001000 - 320 g
[-]/+ [j] Move [ok] OK. [c] Cancel.
```

14.1.2 Setting the display

- ⇒ In counting mode, press **MENU**-key.
- ⇒ Use the navigation keys **↑**, **↓** to select <Display with weight value> and confirm using the **OK**-key.
- ⇒ Select <on> or <off> and confirm using the **OK**-key.

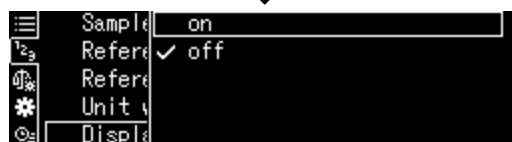
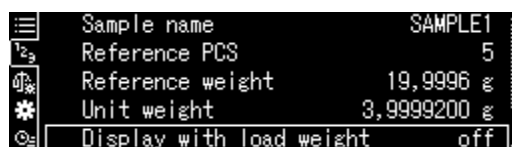

Setting <Off>



Setting <On>

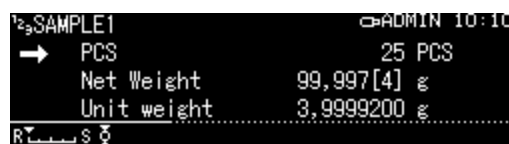

14.1.3 Parts counting

- ⇒ In counting mode, select a stored piece weight and confirm using the **OK**-key (chap. 14.1.1).
- ⇒ Put empty container on the scale and tare.
- ⇒ Fill weighing goods into the container and read the piece quantity.



14.1.4 Change settings

- ⇒ In counting mode, press **Menu**-button.
- ⇒ Select <Changing registration> and confirm using the **OK**-key.
The following changes may be made:

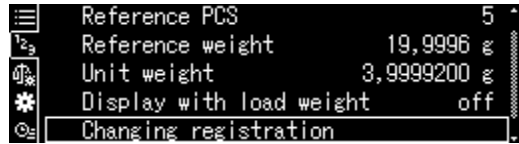

Product name:

Change name and confirm using the **OK**-key.



Reference quantity:

Change reference piece weight and confirm using the **OK**-key.

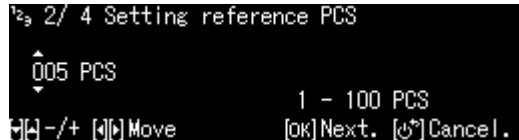

Reference weight:

Load weight and confirm using the **OK**-key.



- ⇒ The changes made will be displayed.

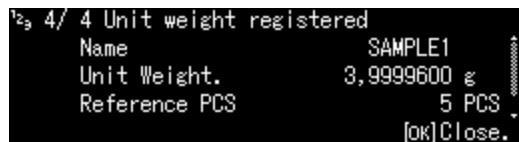

- ⇒ To return to counting mode, press the **ON/OFF**-key

14.1.5 Switching between counting and weighing mode



14.2 Percent determination

Percent weighing allows to display weight in percent, in relation to a reference weight.

The balance offers two possibilities:

1. Loaded reference weight = 100 %
2. Loaded reference weight = user defined

14.2.1 Settings

+ Activate function

Selecting application (see chap. 11.1.4)

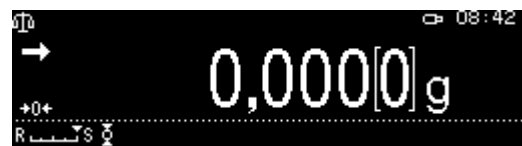

The available applications will be displayed.

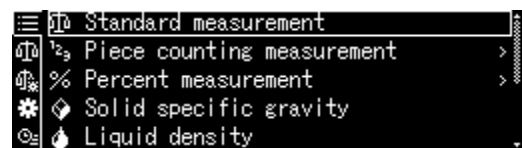

Use the navigation keys \uparrow , \downarrow to select calculation of percentage. The framing will indicate the current selection.

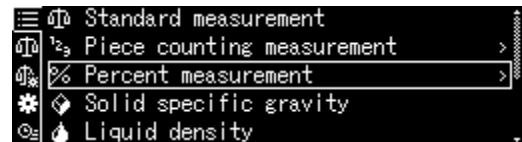

Confirm using the **OK**-key and the application specific settings will be displayed.

100PER1 -3:

Loaded reference weight = 100 %

ANYPER1, 2:

Loaded reference weight = user defined [%]



For the **first input** the display for entering a memory name will appear.
Use the navigation keys **↑**, **↓** to select a memory space and confirm using the **OK**-key.

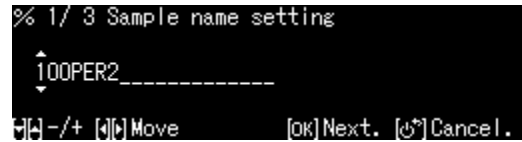

If required, change name and confirm using the **OK**-key.

To **overwrite** a stored reference continue by referring to chap. 14.2.4

Further steps:

- ⇒ **Loaded reference weight = 100 %**
or
- ⇒ **Loaded reference weight = user defined [%]**

+ Loaded reference weight = 100 %

⇒ Select 100PER1, 2 or 3 (or own description) and confirm using the **OK**-key



⇒ If required, place empty container on scale and tare.



⇒ Load reference weight corresponding to 100 %
(Minimum weight: Readability d x 100).
Wait until stability display (→) has settled, then confirm using the **OK**-key.

⇒ The reference will be imported and displayed.

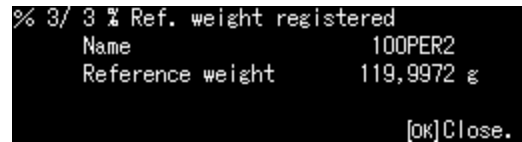

⇒ Confirm using the **OK**-key

⇒ From now on the weight of the sample will be shown in percent based on the reference weight



+ Loaded reference weight = user defined [%]

- ⇒ Select ANYPER1 or 2 (or own description) and confirm using the **OK**-key
- ⇒ Use the navigation keys to enter a percentage value of your choice and confirm using the **OK**-key.
- ⇒ If required, place empty container on scale and tare.
- ⇒ Place reference weight corresponding to the entered percentage value and confirm using the **OK**-key.
- ⇒ The reference will be imported and displayed.
- ⇒ Confirm using the **OK**-key
- ⇒ From now on the weight of the sample will be shown in percent based on the reference weight

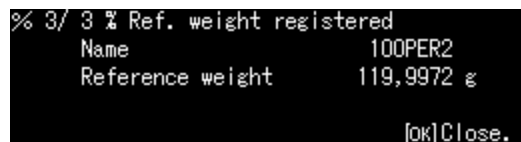
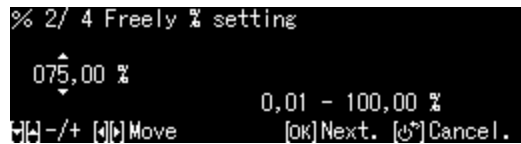

14.2.2 Setting the display

- ⇒ In percentage mode, press the **MENU**-key.
- ⇒ Use the navigation keys **↑**, **↓** to select <Display with weight value> and confirm using the **OK**-key.
- ⇒ Select setting <On> or <Off> and confirm using the **OK**-key.

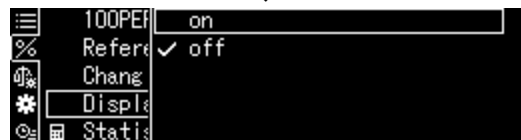
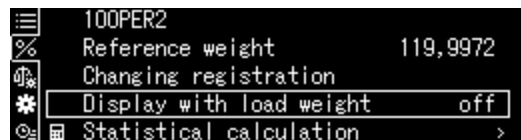

Setting <Off>



Setting <On>

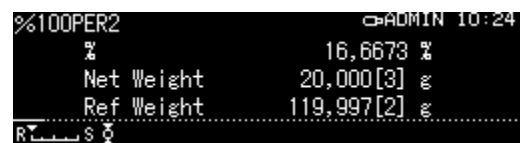

14.2.3 Performing calculation of percentage

⇒ In percentage mode, select stored reference and confirm using the **OK**-key (chap. 14.2.1).



⇒ Put empty container on the scale and tare.

⇒ Fill weighed good into container. The weight of the weighed good will be displayed in percent.



14.2.4 Change settings

⇒ In percentage mode, press the **Menu**-key.

⇒ Select < Changing registration > and confirm using the **OK**-key.
The following changes may be made:

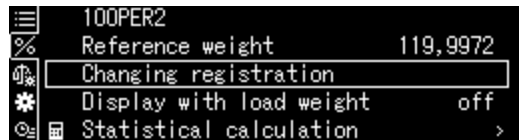

Product name:

Change name and confirm using the **OK**-key.

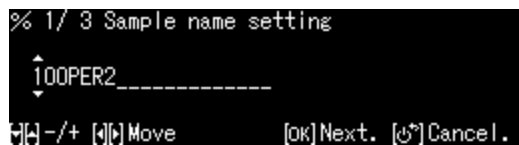

Reference weight:

Load weight and confirm using the **OK**-key.



⇒ The changes made will be displayed.

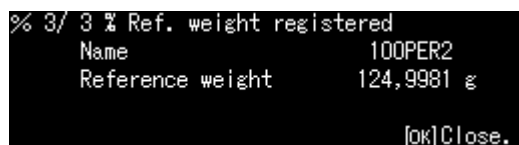

⇒ To return to percentage mode, press the **ON/OFF**-key.

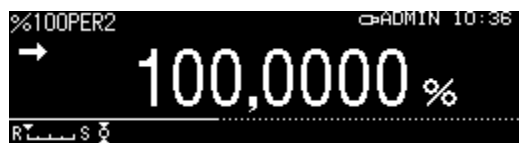

14.2.5 Switching between percentage and weighing mode



14.3 Determining the density of solid matter and liquids

For density determination we recommend working with the optionally available density determination set.

The set contains all the accessories and aids required for easy and precise density determination.

For instructions please see the operating instructions enclosed with the density determination set.

14.4 Totalization

This function is used to automatically add any number of single weighings to a total sum.

When the standstill control (→) is complete the weighing value is automatically issued to an optional printer or a PC. The displayed value is added into the total adding memory. Afterwards automatic taring will take place. This process is repeated newly every subsequent time a new sample is placed on the weighing pan. When the last single weighing process is finished, press the PRINT key to receive the total sum ("TOTAL=").

⇒ Selecting an application, see chap. 11.1.4

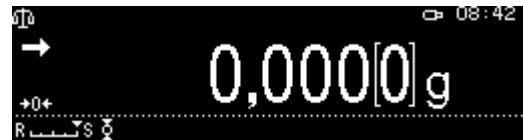

The available applications will be displayed.

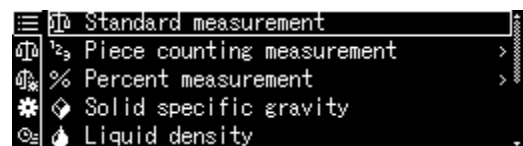

⇒ Use the navigation keys ↑, ↓ to select <Add-on mode>. The framing will indicate the current selection.

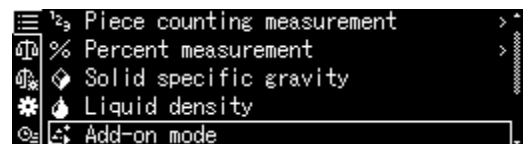

⇒ If required, place the empty container on the scale and tare.

⇒ To start the add-up sequence, press the **OK**-key.

If connected to an optional printer, a header will be issued.



⇒ Place first good to be weighed on balance. When the standstill control (→) is complete the weighing value is automatically issued to the optional printer. The displayed value is added into the total adding memory. Afterwards automatic taring will take place.

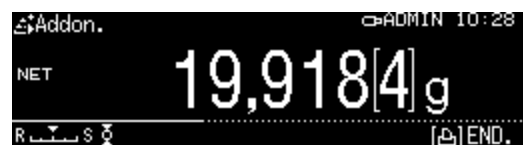

- ⇒ Repeat this sequence for each additional component.
- ⇒ To complete the sequence and to display the total, press the **PRINT**-key.

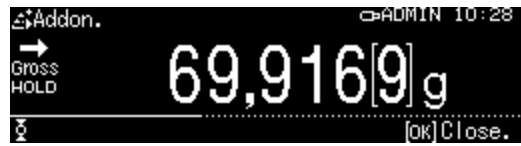

- ⇒ To start another add-up sequence, press the **OK**-key.



Data output:

- ⇒ In totalizing mode press **MENU** button.
- ⇒ Use the navigation keys to select **↑**, **↓** <Print> and confirm using the **OK**-key.



1. Output item number

- ⇒ Use the navigation keys **↑**, **↓** to select <Element No. output> and confirm using the **OK**-key.
- ⇒ Select setting <On> or <Off> and confirm using the **OK**-key.

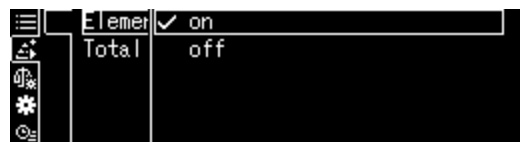
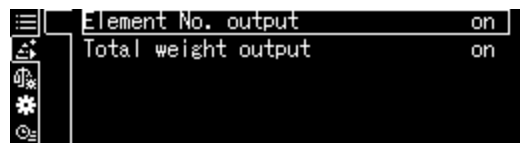

Sample log
Edit component number <On>

Sample log
Edit component number <Off>

ADDON MODE		ADDON MODE	
N001 =	1.004[1] g	1.004[1] g	
N002	0.999[2] g	0.999[2] g	
N003 =	0.999[0] g	0.999[0] g	
N004 =	0.999[1] g	0.999[1] g	
N005 =	0.994[8] g	0.994[8] g	
TOTAL	4.996[2] g	TOTAL = 4,996[2]g	

2. Edit total weight <TOTAL>

⇒ Use the navigation keys **↑**, **↓** to select <Total weight output> and confirm using the **OK**-key.

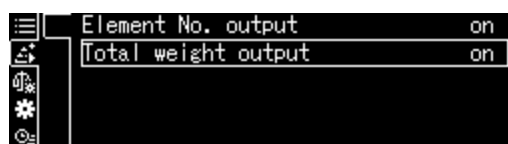

⇒ Select setting <On> or <Off> and confirm using the **OK**-key.

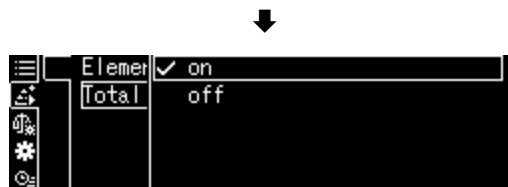

Sample log
Edit total weight <On>

ADDON MODE	ADDON MODE
N001 = 1.004[1] g	N001 = 1.004[1] g
N002 = 0.999[2] g	N002 = 0.999[2] g
N003 = 0.999[0] g	N003 = 0.999[0] g
N004 = 0.999[1] g	N004 = 0.999[1] g
N005 = 0.994[8] g	N005 = 0.994[8] g
TOTAL 4.996[2] g	

Sample log
Edit total weight <Off>

⇒ Return to add-on mode by pressing the **ON/OFF**-key.



14.5 Recipe composition

14.5.1 Free recipe composition

This function can be applied to add weighing different components of a compound. For monitoring purposes the weight of all components (N001, N002 etc.) as well as the total weight may be issued to an optional printer or PC.

The balance works with a separated memory for the weight of the weighing container and of the recipe components.

1. Selecting an application

⇒ see chap. 11.1.4.



The available applications will be displayed.

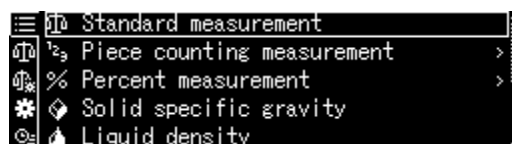

⇒ Use the navigation keys to select **↑** **↓** <Formulation mode>. The framing will indicate the current selection. Confirm using the **OK**-key.

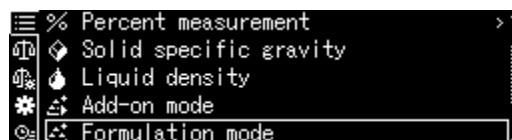

2. Weighing components

⇒ If required, place the empty container on the scale and tare.

⇒ To start the recipe sequence, press the **OK**-key.

If connected to an optional printer, a header will be issued.



⇒ Determine initial weight of first component. Wait until stability display (→) has settled down, then press the **OK**-key. The weighing result will be issued automatically and added to the add-on memory. Afterwards automatic taring will take place. The balance is ready to weigh-in the second component.



- ⇒ Weigh additional components as described above.
- ⇒ To complete the recipe, press the **PRINT**-key. The total will be displayed and issued.
- ⇒ To start a new recipe, press the **OK**-key.

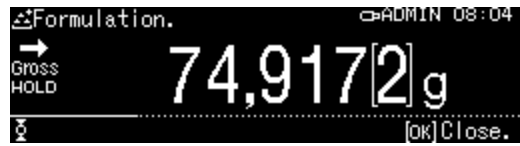

Data output:

- ⇒ In recipe mode, press the **MENU**-key.
- ⇒ Use the navigation keys **↑**, **↓** to select <Printer settings> and confirm using the **OK**-key.



1. Output item number

- ⇒ Use the navigation keys **↑**, **↓** to select <Edit component number> and confirm using the **OK**-key.
- ⇒ Select setting <On> or <Off> and confirm using the **OK**-key.

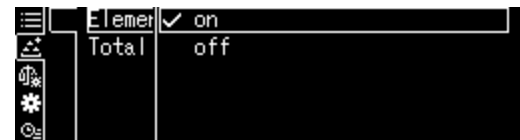
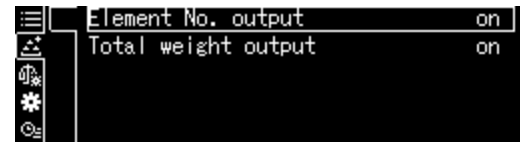

Sample log
Edit component number <On>

Sample log
Edit component number <Off>

FORMULATION MODE		FORMULATION MODE	
N001 =	49.998[2] g		49.998[2] g
N002 =	19.919[1] g		19.919[1] g
N003 =	4.999[9] g		4.999[9] g
TOTAL	74.917[2] g	TOTAL =	74,917[2]g

2. Edit total weight <TOTAL>

⇒ Use the navigation keys **↑**, **↓** to select <Edit total weight> and confirm using the **OK**-key.

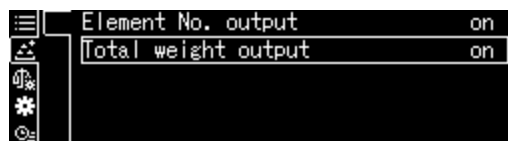

⇒ Select setting <On> or <Off> and confirm using the **OK**-key.

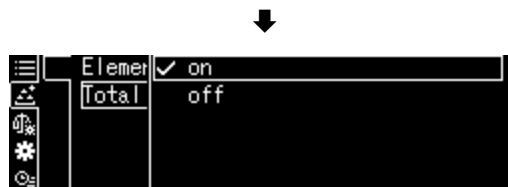

Sample log
Edit total weight <On>

FORMULATION MODE		FORMULATION MODE	
N001 =	49.998[2] g		49.998[2] g
N002 =	19.919[1] g		19.919[1] g
N003 =	4.999[9] g		4.999[9] g
TOTAL	74.917[2] g		

Sample log
Edit total weight <Off>

⇒ To return to recipe mode, press the **ON/OFF**-key.



14.5.2 Define and process recipes

The scale has an internal memory for complete recipes and their components as well as the corresponding parameters (such as recipe name, tolerances, automatic taring etc.). During the processing of these recipes the scale will guide you step-by-step through the initial weighing process of components.

+ Defining recipes

1. Selecting an application

⇒ see chap. 11.1.4.

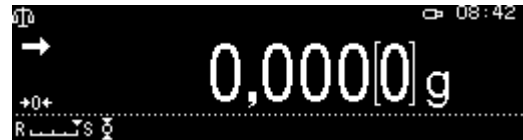

The available applications will be displayed.

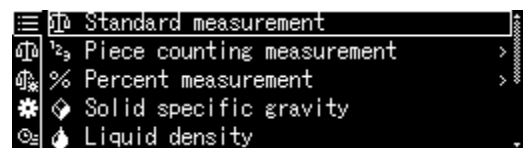

Use the navigation keys **↑**, **↓** to select <Recipe preparation>. The framing will indicate the current selection. Confirm using the **OK**-key.

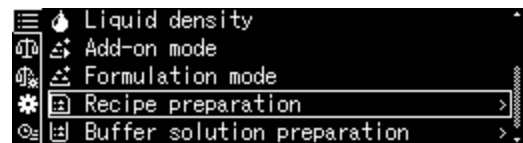

2. Select recipe

⇒ Use the navigation keys **↑**, **↓** select the desired recipe <RECIPE 1 - 5> and confirm using the **OK**-key.



3. Recipe name (at initial input)



To **overwrite** a saved recipe please refer to chap. 14.1.4

The display used to enter a recipe name will appear during an **initial input**. Confirm <Recipe name> using the **OK**-key.

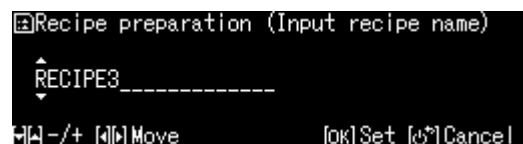
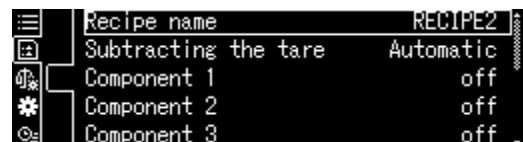

Enter the recipe name such as MiHo-Creme and confirm using the **OK**-key.

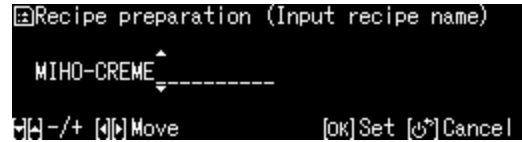

4. Manual and automatic taring after importing individual components.

⇒ Use the navigation keys **↑**, **↓** to select <Subtract tare value> and confirm using the **OK**-key.

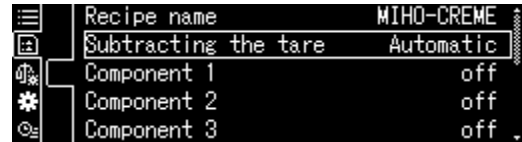

⇒ Select desired setting

Manual:

After taking-over the weighing value of a component by pressing the **OK**-key taring will take place after pressing the **TARE**-key.

Automatic:

After taking-over the weighing value of a component by pressing the **OK**-key, automatic taring will take place.

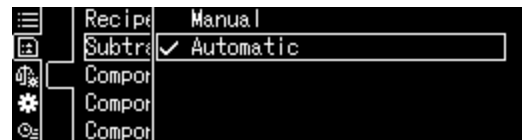

5. Define components

⇒ Use the navigation keys **↑**, **↓** to select a component <Component 1 - 10> and confirm using the **OK**-key. Take-over setting [On] by pressing the **OK**-key.

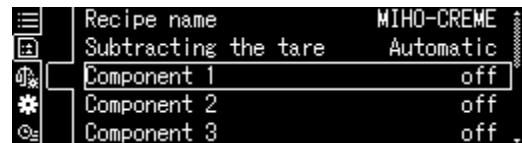

⇒ Use the navigation keys **↑**, **↓** to select <Settings data printout> and confirm using the **OK**-key. Set parameters for component one by one.

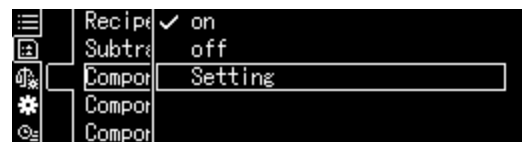

Component name

⇒ Enter component name such as milk (max. 20 characters) and confirm using the **OK**-key

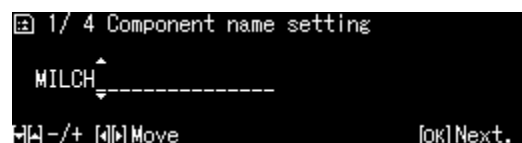
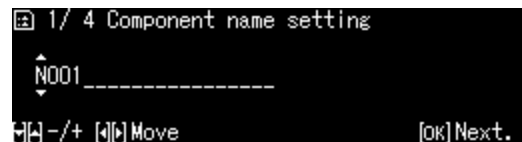

Weighing unit

- ⇒ Select weighing unit and confirm using the **OK**-key

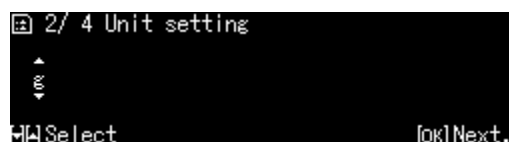

Component weight

- ⇒ Enter weight and confirm using the **OK**-key

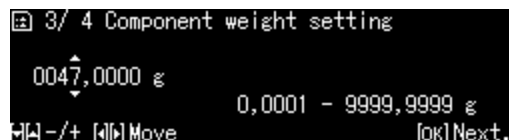

Tolerance of components

- ⇒ Enter tolerance and confirm using the **OK**-key

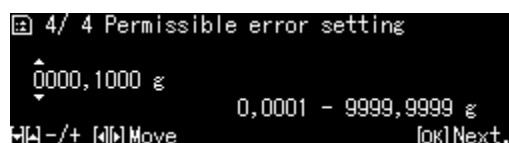

- ⇒ **Repeat step 5 for all components of the recipe**

- ⇒ To return to recipe mode, press the **ON/OFF**-key

+ Process recipe

1. Selecting an application

⇒ see chap. 11.1.4.

The available applications will be displayed.

Use the navigation keys **↑**, **↓** to select <Recipe preparation>. The framing will indicate the current selection. Confirm using the **OK**-key.

2. Select recipe

⇒ Use the navigation keys **↑**, **↓** to select desired recipe such as MiHo-Creme and confirm using the **OK**-key.

⇒ The balance is ready for weighing the first component. The number for the component (such as 1 of 6), component name and the target weight will be displayed.

⇒ Load weighing container and tare.

3. Determine initial weight of component

⇒ Determine initial weight of first component. The weighing aid diagram with its tolerance marks facilitates the determination of the initial weight as a target value.

⇒ Wait for stability sign (→). Apply the achieved target value by pressing the **OK**-key.

Depending on the setting, the display will be reset to zero either automatically, or by pressing the **TARE**-key.

The balance is ready to weigh the second component.

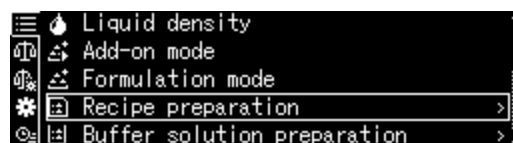
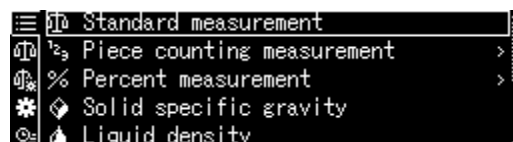

- ⇒ Further components can be weighed as described for the first component. All determined single values taken-over by the **OK**-key will be saved.



4. Completing a recipe composition

- ⇒ Once the last component has been taken-over, the result of the recipe will be displayed and issued automatically.
- ⇒ Finish recipe by pressing the **OK**-key. The memory will be deleted. A new recipe composition may be started.



14.5.3 Change recipe

- ⇒ In recipe mode press **MENU** button.
- ⇒ Select <Change user> and confirm using the **OK**-key.
- ⇒ Make changes as described in section "Define recipe".

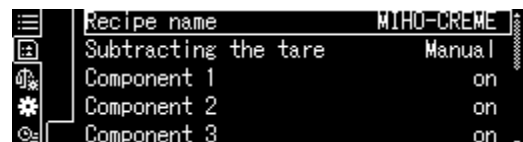

14.5.4 Sample log (KERN YKB-01N):

RECIPE FUNCTION		
NAME		<i>Recipe name</i>
MIHO-CREME		
N001		<i>1. Component</i>
MILK		
TGT=	47,000[0] g	<i>Target value</i>
RNG=	0.100[0] g	<i>Tolerance</i>
WEI=	47.014[1] g	<i>Weighed-in quantity</i>
DIF=	0.014[1] g	<i>Deviation from target value</i>
N002		<i>2. Component</i>
ALMOND OIL		
TGT=	95,000[0] g	<i>Target value</i>
RNG=	0.100[0] g	<i>Tolerance</i>
WEI=	95.005[7] g	<i>Weighed-in quantity</i>
DIF=	0.005[7] g	<i>Deviation from target value</i>
N003		<i>3. Component</i>
HONEY		
TGT=	8,000[0] g	<i>Target value</i>
RNG=	0.100[0] g	<i>Tolerance</i>
WEI=	7.990[6] g	<i>Weighed-in quantity</i>
DIF=	0.009[4] g	<i>Deviation from target value</i>
N004		<i>4. Component</i>
BEZOE-OIL		
TGT=	0.600[0] g	<i>Target value</i>
RNG=	0.100[0] g	<i>Tolerance</i>
WEI=	0.600[6] g	<i>Weighed-in quantity</i>
DIF=	0.000[6] g	<i>Deviation from target value</i>
N005		<i>5. Component</i>
OLIBANUM OIL		
TGT=	0.600[0] g	<i>Target value</i>
RNG=	0.100[0] g	<i>Tolerance</i>
WEI=	0.611[8] g	<i>Weighed-in quantity</i>
DIF=	0.011[8] g	<i>Deviation from target value</i>
TOTAL =	151,222[8]g	<i>Total</i>



For settings for data output, see chap. 14.5.1 "Data output".

14.6 Preparing buffer solutions

The factory setting provides the scale with the following 13 recipes for preparing buffer solutions.

No.	Substance amount concentration	Buffer system	pH value
1	100mM	Phosphoric acid (sodium)	pH = 2.1
2	10 mM	Phosphoric acid (sodium)	pH = 2.6
3	50mM	Phosphoric acid (sodium)	pH = 2.8
4	100mM	Phosphoric acid (sodium)	pH = 6.8
5	10mM	Phosphoric acid (sodium)	pH = 6.9
6	20mM	Citric acid (sodium)	pH = 3.1
7	20mM	Citric acid (sodium)	pH = 4.6
8	10mM	Tartaric acid (sodium)	pH = 2.9
9	10mM	Tartaric acid (sodium)	pH = 4.2
10	20mM	Acetic acid (ethanolamine)	pH = 9.6
11	100mM	Acetic acid (sodium)	pH = 4.7
12	100mM	Boracic acid (potassium)	pH = 9.1
13	100mM	Boracic acid (sodium)	pH = 9.1

1. Selecting an application

⇒ see chap. 11.1.4.

The available applications will be displayed.

Use the navigation keys **↑**, **↓** to select <Buffer solution preparation>. Confirm using the **OK**-key.

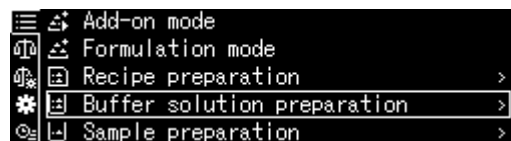
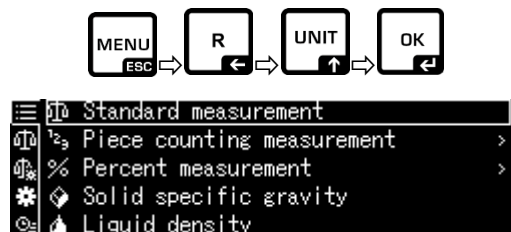

2. Selecting a buffer system

- ⇒ Use the navigation keys **↑**, **↓** to select the desired buffer solution from the list and confirm using the **OK**-key.

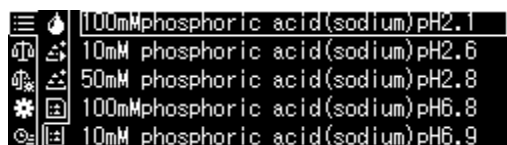

3. Tolerance of components

- ⇒ Press **MENU** button
- ⇒ Select <Admitted errors> and confirm using the **OK**-key.
- ⇒ Enter tolerance and confirm using the **OK**-key, selectable 0.0001g – 9.9999g.
- ⇒ To return to the previous menu, press the **MENU**-key.

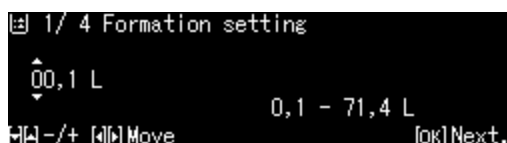
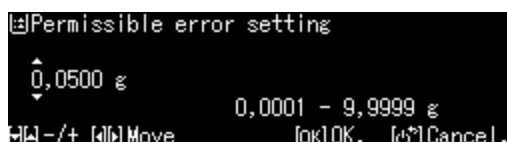
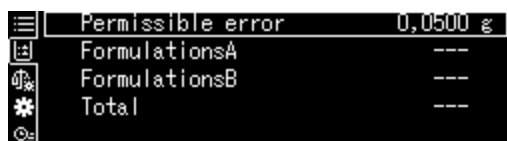
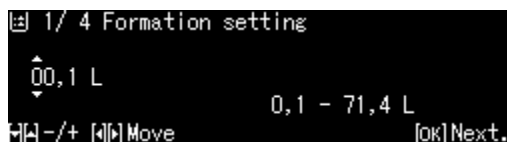

4. Enter volume

- ⇒ Enter volume and confirm using the **OK**-key.
- ⇒ The balance is ready for weighing the first component. Displays the component name and the nominal weight.
- ⇒ Load weighing container and tare.

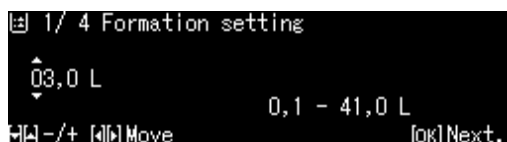

5. Add components

- ⇒ Weigh displayed component.
The weighing aid diagram with its tolerance marks facilitates the determination of the initial weight as a target value.
- ⇒ Wait for stability sign (→). Apply the achieved target value by pressing the **OK**-key.
- ⇒ Add the displayed volume of the second component using a chemical dropper.
- ⇒ Confirm using the **OK**-key

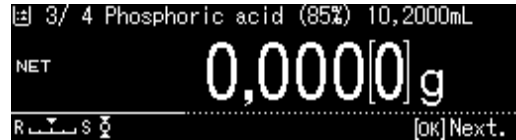

6. Completing recipe composition

- ⇒ Once the last component has been applied, the result will be displayed and issued automatically.
- ⇒ Finish by pressing the **OK**-key.
The memory will be deleted. A new recipe composition may be started.

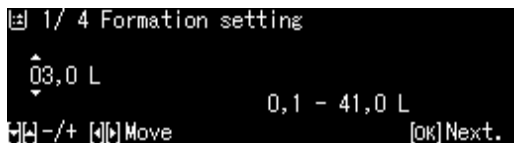

14.7 Sample preparation

This function is used to calculate automatically and to prepare standard solutions with a special component based on hydrochloride or hydrate compounds.

The following sample types are available.

Salts (Hydrochloride)	Target weight (g) = $\frac{\text{Molecular weight}}{\text{Molecular weight} - \text{weight of salt} \times 36.45} \times \text{active substance (g)}$
Molecular weight	Target weight (g) = $\frac{\text{Molecular weight}}{\text{Molecular weight of active substance}} \times \text{active substance (g)}$
Hydrate	Target weight (g) = $\frac{\text{Molecular weight}}{\text{Molecular weight} - \text{weight of hydrate} \times 18.02} \times \text{active substance (g)}$
Purity	Target weight (g) = $\frac{100\%}{\text{Purity (\%)}} \times \text{active substance (g)}$

+ Define sample preparation

For selecting application, see chap. 11.1.4



The available applications will be displayed.

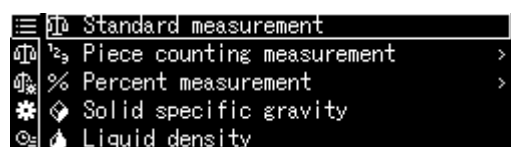

Use the navigation keys to select \uparrow \downarrow <Sample preparation>.

The framing will indicate the current selection. Confirm using the **OK**-key.

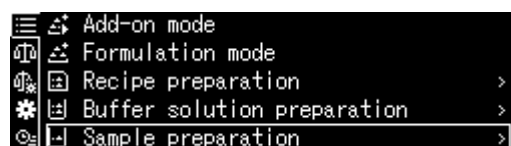

For the **first input** the display for entering a memory name will appear. Use the navigation keys **↑**, **↓** to select a memory space and confirm using the **OK**-key.

If required, change name and confirm using the **OK**-key.

```
SAMPLE01
SAMPLE02
SAMPLE03
SAMPLE04
SAMPLE05
```



```
1/ 4 Sample name setting
SAMPLE2_____
[-]/+ [M] Move [OK] Next. [C] Cancel.
```



```
1/ 6 Sample name setting
FURSULTIAMIN_____
[-]/+ [M] Move [OK] Next.
```



To overwrite a saved sample please continue by referring to chap. 14.7.1

⇒ Use the navigation keys **↑**, **↓** to select sample type and confirm using the **OK**-key.

Options:

<Hydrate>

<Purity>

<Molecular weight>

<Hydrochloride>

⇒ Enter the weight for the required active substance and confirm using the **OK**-key.

```
2/ 6 Sample type setting
Hydrochloride
[-]/+ [OK] Next.
```

⇒ Enter tolerance and confirm using the **OK**-key.

```
3/ 6 Collection weight setting
000,0100 g
0,0001 - 320,0000 g
[-]/+ [M] Move [OK] Next.
```

⇒ Enter molecular weight of component and confirm using the **OK**-key.

```
4/ 6 Tolerance range setting
000,0010 g
0,0001 - 0,0100 g
[-]/+ [M] Move [OK] END.
```

⇒ Enter quantity of chloride groups and confirm using the **OK**-key.

```
5/ 6 Molecular weight setting
0398,5400
36,5000 - 9999,9999
[-]/+ [M] Move [OK] Next.
```

⇒ Save by pressing the **OK**-key. The values for the samples are displayed.

```
6/ 6 Number of hydrochloride setting
0001
1 - 10
[-]/+ [M] Move [OK] END.
```

```
Sample preparation FURSULTIAMIN
Target 0,0110 g
Gross 0,000[1] g
+0+ Picking 0,000[1] g
R s
```

+ Preparing a sample

1. Select application <Sample preparation>

⇒ See previous paragraph Define “Sample preparation”

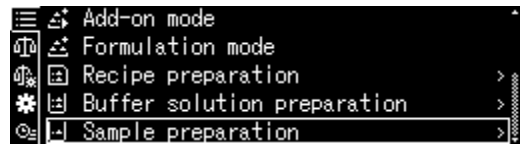

2. Select sample

⇒ Use the navigation keys ↑, ↓ to select the desired sample and confirm using the **OK**-key.

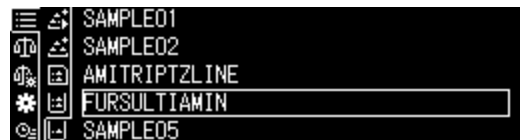

3. Determine initial weight for component

⇒ Weigh the component until the target weight is identical to the gross weight. The weighing aid graph with its tolerance marks facilitates matching the initial weight to the target weight.

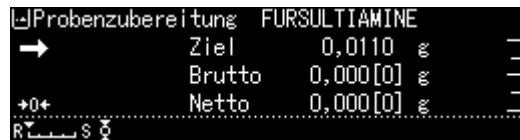

Target weight → Target 0,0110 g

Current weighing value → Gross 0,011[7] g

Active substance → Picking 0,010[6] g

The tolerance mark "OK" indicates the achievement of the target weight.

14.7.1 Changing saved samples

⇒ In sample preparation mode press **MENU** button.

⇒ Select <Work on current sample> and confirm using the **OK**-key.

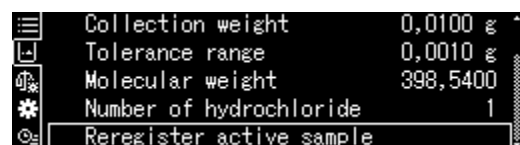

⇒ Make changes as described in the previous paragraph.

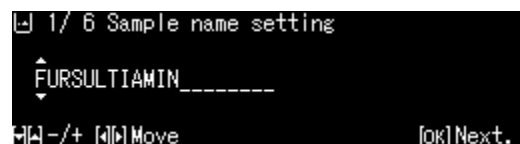

14.8 Statistics

The Statistics function facilitates the statistical evaluation of weighing values.

Combinable functions:

Standard weighing mode, parts counting, percentage determination, animal weighing, density determination <Solids>, density determination <Liquids>

1. Select application to be applied to statistics

- ⇒ See chap. 11.1.4
The available applications will be displayed.
- ⇒ Select the desired application using the navigation keys \uparrow \downarrow .
The framing will indicate the current selection. Confirm using the **OK**-key.

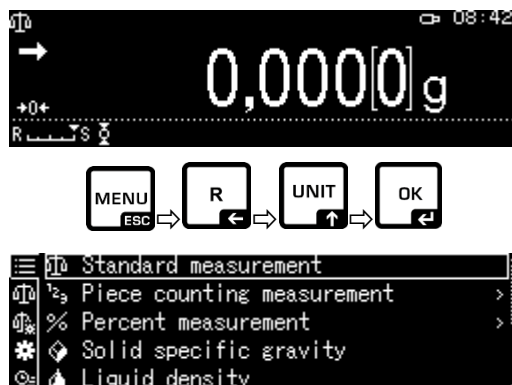

2. Start statistics

- ⇒ Press **MENU** button.
- ⇒ Select < Statistical calculation > and confirm using the **OK**-key.
- ⇒ Select <Start Statistical calculation> and confirm using the **OK**-key.
The header will be issued to an optional printer.
- ⇒ Put first weighed good on weighing plate and wait for stability sign (\rightarrow).
- ⇒ Save weighing value to statistics by pressing the PRINT-key.
- ⇒ Put additional weighed good on platform and save each weighing value to statistics by pressing the PRINT-key.
Each time you save a value it will be logged automatically.

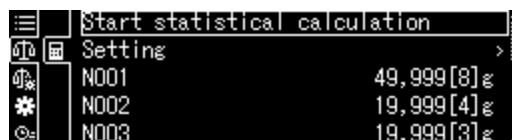
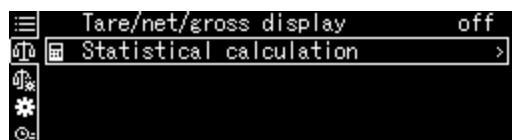

3. Finish statistics

- ⇒ Press **MENU** button.
- ⇒ <Finish Statistical calculation ends>
The result will be issued automatically.

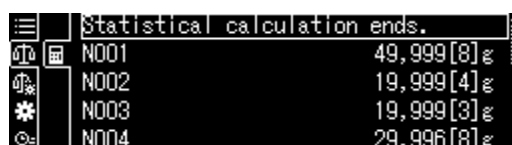

Sample log
Print sample number <On>

STATISTICS

N001 = 1,0047g
 N002 = 0,9990g
 N003 = 0,9984g
 N004 = 0,9983g
 N005 = 0,9989g

1. Weighing value
 2. Weighing value
 3. Weighing value
 4. Weighing value
 5. Weighing value

..... <RESULT>

N = 5
 T = 4,9993 g
 MAX = 1,0047 g
 MIN = 0,9983 g
 RNG = 0,0064
 MEAN = 0,99986 g
 SD = 0,00272 g
 CV% = 0,00 %
 V = 0,00001

Number of samples
 Total
 Biggest weight value
 Smallest weight value
 Difference smallest /
 greatest weighing value
 Mean Value
 Standard Deviation
 Relative standard deviation
 Fraction
 Calculation:

$$s = \sqrt{\frac{1}{n-1} \{ \sum (x_i - \bar{x})^2 \}}$$

s Standard Deviation
 n Number
 x_i: Weighing value

14.9 Control weighing and target weighing

This function is used to determine the matching of a weighing value to the specified control values.

Control values can be exact target values (target weighing) or the limits set for the tolerance range (control weighing) within which the weighing value is to be kept.

14.9.1 Target weighing

This mode e.g. is used for weighing constant liquid quantities or for assessment of missing quantities or excess quantities.

The target value is the numeric value which corresponds to the nominal quantity of the used unit. Beside the target value a tolerance value is entered. This is a numerical value which is plus/minus over or under the acceptable target value.

Reaching of target value is shown on the diagram. The tolerance marks **HI**, **OK** or **LO** indicate whether the weighed good is below, within or above the specified tolerances.

+ Settings

1. Call up weighing settings

In weighing mode press **MENU** button.

Press the **R-Taste** key and use the navigation keys **↑**, **↓** to select **<Weighing Settings>** and confirm using the **OK**-key.

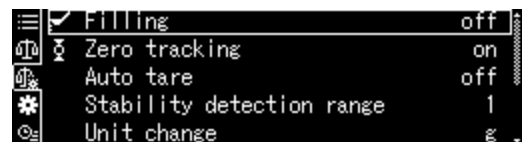

2. Activate function

Use the navigation keys **↑**, **↓** to select **<Target measurement>** and confirm using the **OK**-key.

Select **Settings <On>** and confirm using the **OK**-key.

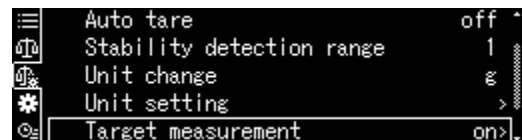

3. Setting target value

⇒ Select **<Setting>** and confirm using the **OK**-key.

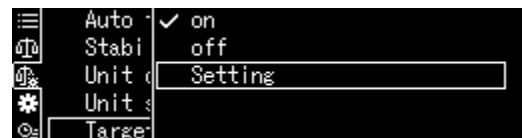

- ⇒ Select <Target value> and confirm using the **OK**-key.

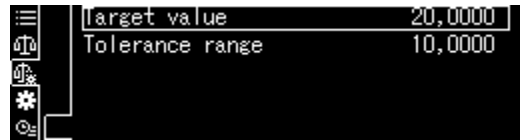

- ⇒ Enter target value and confirm using the **OK**-key.

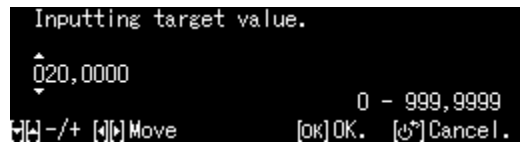

4. Setting tolerance

- ⇒ Select <Tolerance range> and confirm using the **OK**-key.

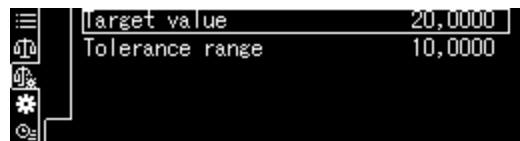

- ⇒ Enter tolerance and confirm using the **OK**-key.

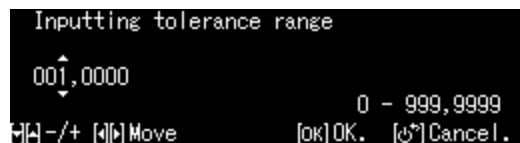

- ⇒ To return to target weighing mode, press the **ON/OFF**-key.



+ Perform target weighing



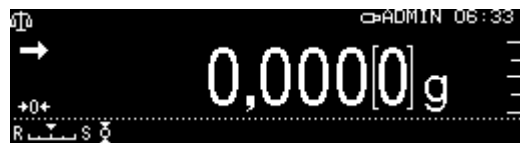

- ⇒ If required, place empty container on scale and tare.

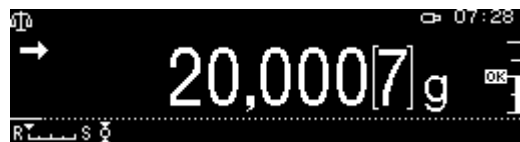

- ⇒ Place weighed goods and wait until the tolerance mark **HI**, **OK** or **LO** appears. With the help of the tolerance mark check if the weighed goods are under, inside or over the default tolerance.



The tolerance marks provide the following information:

Condition	Grading	Status Tolerance mark	Optical signal	Example: Target value 100g Tolerance 0.0010g
Weight more than the nominal weight and above the upper tolerance	Great difference to target value		flashes slowly (Cycle: 1,5 - 2 s)	< 150 g
	Small difference to target value (<25 %)		flashes fast (Cycle: 0.5 - 1 s)	< 125 g
Weight within tolerance (target value ± tolerance)	Target value accepted		Not flashing	99.9990 – 100.0010 g
Weight less than nominal weight and below the lower tolerance	Great difference to target value (> 25 %)		flashes fast (Cycle: 0.5 - 1 s)	> 75 g
	Small difference to target value		flashes slowly (Cycle: 1,5 - 2 s)	> 50g

14.9.2 Control weighing (Pass / Fail evaluation)

In many cases not the nominal value of the weighed goods is the decisive parameter, but the deviation from this nominal value. Such applications are for example the weight check of equivalent packages or the process check of parts in a fabrication process.

By entering the upper and lower limit value you can ensure that the weighed weighing good remains exactly within the set tolerance range at all time. If the values of limits are exceeded or not reached this will be indicated by the displayed indicators **HI**, **OK** or **LO**.

+ Settings

1. Call up weighing settings

In weighing mode press **MENU** button.

Press the **R-Taste** key and use the navigation keys **↑**, **↓** to select [Weighing Settings] and confirm using the **OK**-key.

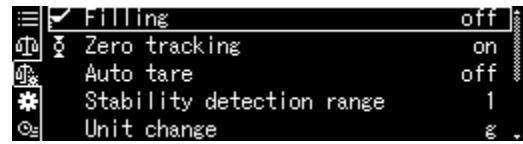

2. Activate function

Use the navigation keys **↑**, **↓** to select <Pass/fail evaluation> and confirm using the **OK**-key.

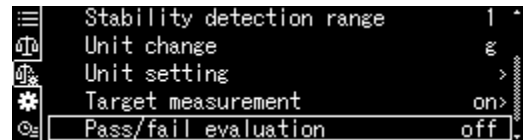

Select Settings <On> and confirm using the **OK**-key.



3. Setting limits

⇒ Select <Setting> and confirm using the **OK**-key.

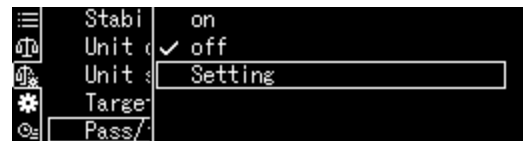

⇒ Define the limit values one by one and confirm using the **OK**-key.
When entering the limit values ensure that the values match logically one with another, i.e. the lower limit value must not be greater than the upper one.

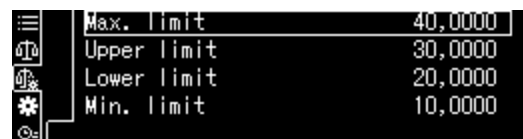

⇒ To return to control mode, press the **ON/OFF**-key

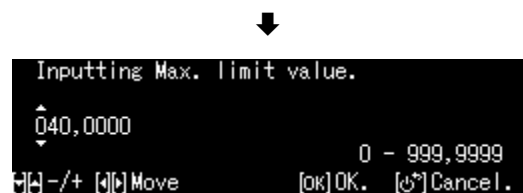

+ Perform control weighing

⇒ If required, place empty container on scale and tare.



⇒ Place weighed goods and wait until the tolerance mark **HI**, **OK** or **LO** appears. Apply the tolerance marks to check whether the weighed good is within the set tolerance range.

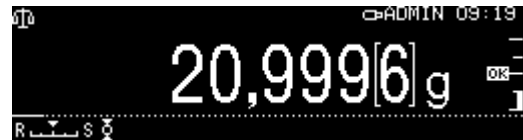

Input example:	Upper range limit	40.0000 g
	Upper limit	30.0000 g
	Lower limit	10.0000 g
	Lower range limit	20.0000 g

	Weighing value >	Upper range limit	> 40.0000 g	Beyond tolerance limit. No tolerance mark shown.
Upper limit value	< Weighing value ≤	Upper range limit	>30.0000g – 40.0000g	
Lower limit	≤ Weighing value ≤	Upper limit value	≥20.0000g – 30.0000g	
Lower range limit	≤ Weighing value <	Lower limit value	10.000 g – 19.9999 g	
	Weighing value <	Lower range limit	< 10.0000 g	Beyond tolerance limit. No tolerance mark shown.

14.10 Minimum sample weight

The default setting for the function "Minimum initial weight" is "locked".

Settings can only be defined locally in connection with a DakkS calibration. For further information please see KERN-Homepage (www.kern-sohn.com).

15 Interfaces

Via the interfaces weighing data may be exchanged with connected peripheral devices.

Issue may be made to a printer, PC or check displays. In the same way, control commands and data inputs may occur via the connected devices (such as PC, keyboard, barcode reader).

15.1 Connect printer

Turn off scale and printer.

Use a suitable cable to connect the weighing balance to the interface of the printer.

Faultless operation requires an adequate KERN interface cable (optional).

Turn on scale and printer.

Communication parameters (Baud rate, bits and parity) of scale and printer must match, see chap. 15.7

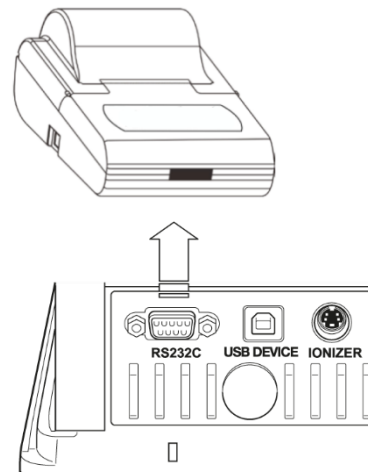

15.2 Connect PC

Turn off scale and connect it to a PC as shown on the diagram.

Switch on balance

The USB driver will be installed automatically.

If required, a suitable driver is available for downloading from our KERN- Homepage www.kern-sohn.com/Downloads. Select the driver version compatible with your system and execute the exe file.

We recommend our transfer software 'Balance Connection KERN SCD 4.0' for the import of data to a PC program.

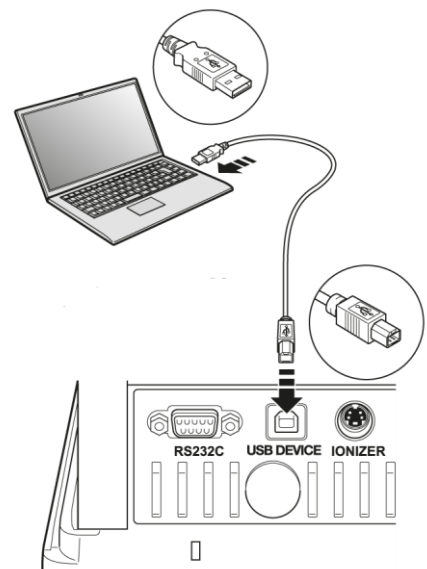

15.3 Connect serial devices / connect programmable controller (SPS / PLC)

Turn off scale and device.

Connect scale to interface of device, using a suitable RS232C cable.

Faultless operation requires an adequate KERN interface cable (optional).

Turn on scale and device.

Adapt communication parameter of scale and device, see chap. 15.7

Data is issued or received via the **PRINT**-key or control commands.

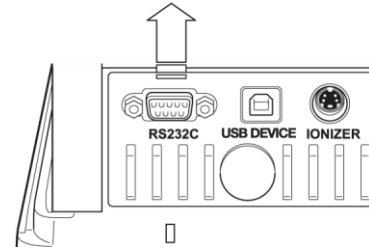

15.4 Interface cable (RS232)

Serial device			Scale 9-pole	
RXD	2	_____	3	TXD
TXD	3	_____	2	RXD
DTR	4	_____	6	DSR
SG	5	_____	5	SG
DSR	6	_____	4	DTR
RTS	7] _____ [7	RTS
CTS	8] _____ [8	CTS

15.5 Data transmission format

1. Standard format example [-123.4567]

	①	②								③	④		
Positon	1	2	3	4	5	6	7	8	9	10	11	12	13
ASCII	2DH	31H	32H	33H	2EH	34H	35H	36H	37H	20H	67H	20H	0DH
Data	-	1	2	3	.	4	5	6	7		g		C/R

No.	Description	
①	Signs	[_] positive values (blanks)
		[-] negative values
②	Weighing value	Numeric weighing value is displayed in eight positions. Not required positions = space character 20H Possible overload, presented in 2 positions with O L. For scales with type approval the verified value is presented in brackets "[]". This way the data length is increased by two positions.
③	Unit	1 character: Position 11
		3 character: Position 11-13
		4 character: Position 11-14
④	Final character	Separator C/R = 0DH, L/F = 0AH At CR+LF data length will be increased by one position.

2. Stable / unstable weighing value:

Positon	1	2	3	4
ASCII	53H	2D H	31H	32H
Data	S	-	1	2

stable S (53H)
unstable U (55H)













15.6 Interface commands

The weighing balance recognises the commands listed below.

1. Data output

Order	Function
D02	Continuous data output of stable weighing values
D03	Status of stability display is attached to the data in the continuous output (U: instable; S: stable).
D05	Single output
D06	Automatic output
D07	Single output. Status of stability display is attached to the data in the output (U: instable; S: stable). (not applicable in ABP-A series)
D08	Single output with stable weighing value
D09	Cancel output

2. Key operations

Order	Function
POWER	Press simulation 
DIGIT	Press simulation 
PRINT	Press simulation 
TARE	Press simulation 
CAL	Press simulation 
MENU	Press simulation 
ION	Press simulation 
ENTER	Press simulation 
UP	Press simulation 
DOWN	Press simulation 
LEFT	Press simulation 
RIGHT	Press simulation 

3. Application settings

Order	Function
Standard weighing mode	
R	Quit standard weighing mode
Piece counting	
PCS	Call function (? : no. 1- 5)
UW?=XX.XXXX	Determine single weight by weighing ?: Nr. 1- 5 XX.XXXX: Weighing value
UW	Count parts (? : no. 1- 5)
UB?=XXXXX	Enter single weight as numeric value [XXXXX] (? : no. 1- 5)
UW	Count parts (? : no. 1- 5)
RECALC	Recalculate single weight
Percentage calculation	
G	% ⇄ g
%?	Select reference ?: No. 1- 3. If no reference is set, the currently loaded weight will be saved as reference (=100%).
% W ? = XX.XXXX	Determine reference ?: Nr. 1 - 3 XX.XXXX: Loaded reference weight = 100 %
% W ?	Percentage calculation (? : No. 1- 3.)
Recipe composition	
M	Call function
Totalization	
+	Call function
Density determination of solids	
SD	Call function
Determining density of liquids	
LD	Call function

4. Control weighing and target weighing

Order	Function
Target weighing	
TRGT	Call function
TARGET=XX.XXXX	Select target weight
LIMIT=XX.XXXX	Select tolerance
Checkweighing	
CHKW	Call function
OVR.RNG=XX.XXXX	Select max target weight
HI.LIM=XX.XXXX	Select upper tolerance
LO.LIM =XX.XXXX	Select lower tolerance
UND.RNG=XX.XXXX	Select min target weight
Start tolerance check	
GO	HL: Outside upper tolerance range
	HI: Weight greater than target weight
	OK: Weight within tolerance
	LO: Weight lower than target weight
	LL: Outside lower tolerance range

5. Adjustment and weighing units

Order	Function
Adjustment	
ICAL	Internal adjustment
ECAL	External adjustment
ECAL.W=XXX.XXXX	Enter weight value for external adjustment weight (XXX.XXXX) [g].
Weighing Units	
g	Activate the weighing unit, in which can be toggled with the UNIT key.
mg	
ct	

6. System Settings

Order	Function
Software scale	
ID=XXXX	Select scale ID no. (default setting [0 0 0 0])
ID	Display scale ID no.
STATE	Printout list of current menu settings
TIME	Display date / time
User administration	
LOGIN=XXXX: YYYY	Login XXXX : User name (max 20 characters) YYYY: Password (4 characters)
LOGOUT	Logout
UID	Display currently logged-in user

7. Miscellaneous

Order	Function
TYPE	Model
VER	Software version
SN	Serial number
MAX	Weighing range (max)
MIN	Readability

8. Automatic door commands (only ABP-A)

Order	Function
RO=LLLRRRUUU	Settings of the open position for each door LLL: open position of the left door. Set value between 20 and 100 (%). RRR: open position of the right door. Set value between 20 and 100 (%). UUU: open position of the upper door. Set value between 20 and 100 (%).
OA	Open the upper, right and left door (all 3)
WS 0	Close the upper, right and left door (all 3)
WS 1	Open the right door
CR	Close the right door
WS 2	Open the left door
CL	Close the left door
OU	Open the upper door
CU	Close the upper door
DOORR	Button to open and to close the door (right)
DOORL	Button to open and to close the door (left)

15.7 Communication parameters

All communication parameters will be set (see chap. 15.7.1) by calling a standard setting.

The subsequent standard setting must be selected according to the printer (details see the following table).

All parameters may be of course also set in a user specific way (See chap. 15.7.2).

Menu selection	Effective	Enhanced	Type M	Type S	Type A		
Manufacturer	KERN (Standard)	KERN *	Mettler	Sartorius	A & D	-	- Setting for KERN YKB-01N
Baudrate	1200	1200	2400	1200	2400	user-defined	9600
Parity	None (8)	None (8)	Even (7)	Odd (7)	Even (7)	user-defined	None (8)
Stop bit	1	1	2	2	2	user-defined	1
Handshake	off	off	off	Hardware	off	user-defined	off
Data format	KERN Standard	KERN Standard	Mettler Standard	Sartorius Standard	A & D Standard	user-defined	FREE
Separator	C/R	C/R	C/R + L/F	C/R + L/F	C/R + L/F	user-defined	C/R

*only if the balance can send a feedback to the PC (without error: OK [C/R], at error NG [C/R]).

15.7.1 Select standard setting

1. Call function

Press and hold **PRINT**-key for approx. 3 sec.

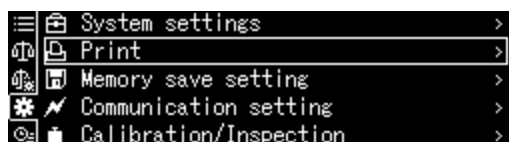

Use the navigation keys to select <Communication setting> and confirm using the **OK**-key.

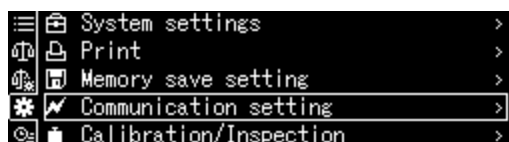

Use the navigation keys to select interface and confirm using the **OK**-key.



2. Select setting

The available settings will be displayed, see chap. 15.7

- Effective
- Enhanced
- Type M
- Type S
- Type A
- User-defined

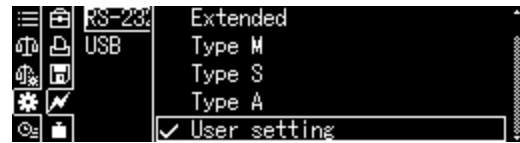

Select desired setting with the help of the navigation keys and confirm using the **OK**-key.

Use the **ON/OFF** button to return into weighing mode



15.7.2 User defined settings (display example for KERN YKB-01N)

Every communication parameter can be set individually in the menu item "User setting".

Call function:

Press and hold **PRINT**-key for approx. 3 sec.

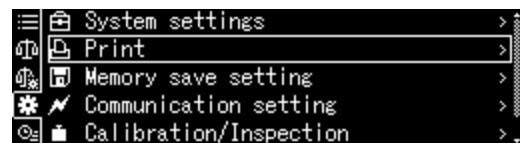

Use the navigation keys to select <Communication setting> and confirm using the **OK**-key.

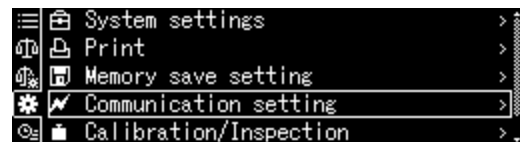

Use the navigation keys to select interface and confirm using the **OK**-key.



Use the navigation keys to select <User-defined> and confirm using the **OK**-key.

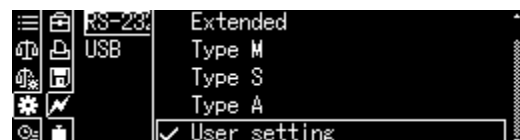

Setting communication parameters:

Use the navigation keys to select the available settings one by one and confirm using the **OK**-key.

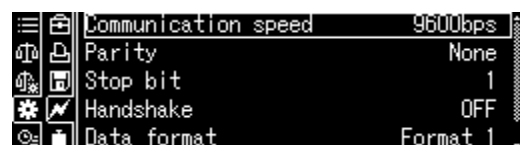

1. Communication speed (Baudrate)

Use the navigation keys to select <Communication Speed> and confirm using the **OK**-key.

Select setting and confirm using the **OK**-key.



2. Parity

Use the navigation keys to select <Parity> and confirm using the **OK**-key.

Select setting and confirm using the **OK**-key.

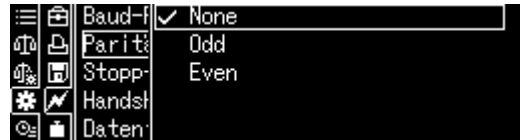

None	No parity, 8 bit
Odd	Odd parity, 7 bit
Even	Even parity, 7 bit

3. Stop bit

Use the navigation keys to select <Stop-bit> and confirm using the **OK**-key.

Select setting and confirm using the **OK**-key.

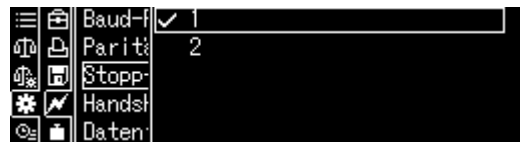

1	1 bit
2	2 bit

4. Handshake

Use the navigation keys to select <Handshake> and confirm using the **OK**-key.

Select setting and confirm using the **OK**-key.



OFF	No handshake
HARD	Hardware Handshake
SOFT	Software Handshake
TIMER	Timer Handshake

5. Data format

Use the navigation keys to select <Data format> and confirm using the **OK**-key.

Select setting and confirm using the **OK**-key.

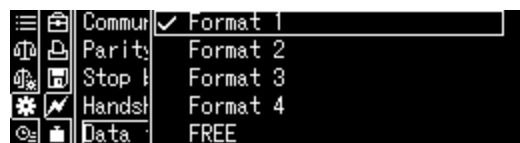

Format 1	KERN Standard
Format 2	Mettler Extended
Format 3	Sartorius Standard
Format 4	A&D Standard
FREE	Options: byte 1 -99, Data length 1 -99

6. Final character

Use the navigation keys to select <Limiter> and confirm using the **OK**-key.
Select setting and confirm using the **OK**-key.



Return to weighing mode

Press **ON/OFF** repeatedly or for 3 s.

15.8 Issue functions

15.8.1 Automatic data output / Auto Print function

Data output happens automatically without having to press the **PRINT**-key as soon as the corresponding output condition has been met, dependent on the setting in the menu.



The  icon will be displayed while the function is enabled.

Not combinable with the continuous data output.

Call function:

Press and hold **PRINT**-key for approx. 3 sec.
Confirm <Printing> by pressing the **OK**-key.



Select settings <Automatic printing> and confirm using the **OK**-key.

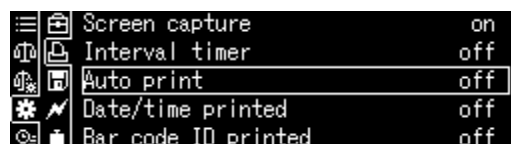

Select Settings <On> and confirm using the **OK**-key.

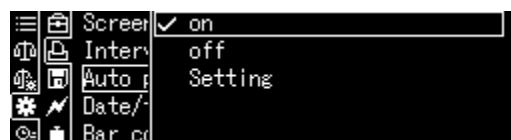

Set output condition:

Use the navigation keys <Settings data output> and confirm using the **OK**-key.

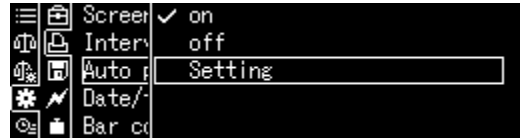

Use the navigation keys to select the desired setting and confirm using the **OK**-key.

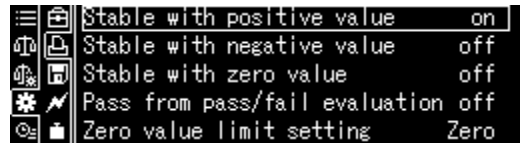

Stable/positive value	Single output for stable and positive weighing value.	
Stable/negative value	Single output for stable and positive or negative weighing value.	
Stable at zero	Single output for stable and positive weighing value. New output only after zero display and stabilization	
Pass/ Fail	If the Auto Print function is connected to the check weighing function, data of stable weighing values are output with indicator display OK .	
Set zero value limit	[Zero]	Another output when the display goes back to zero. Setting for priority of accuracy
	[50 % of previous output]	Another output when the display goes back to 50% of the previous weighing value. Setting for priority of work efficiency

Return to weighing mode

Press the **ON/OFF** button.
From here on the Auto Print function is active, the indicator  is displayed.

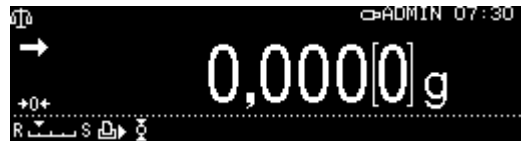

Place goods to be weighed on balance

- ⇒ If required, place empty container on scale and tare.
- ⇒ Place weighed goods and wait until the stability display (➔) appears. The weighing value is issued automatically.
- ⇒ Remove the weighed good.

15.8.2 Continuous data output



The  icon will be displayed while the function is enabled.
Not combinable with automatic data output.

Call function:

Press and hold **PRINT**-key for approx. 3 sec.
Confirm <Print> using the **OK**-key.



Select Settings <Interval clocking> and confirm using the **OK**-key.



Select Settings <On> and confirm using the **OK**-key.

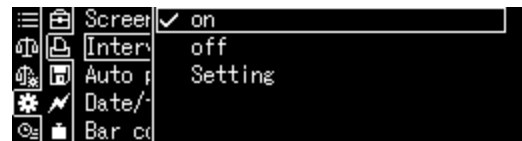

Setting output interval:

Use the navigation keys to select <Settings data output> and confirm using the **OK**-key.

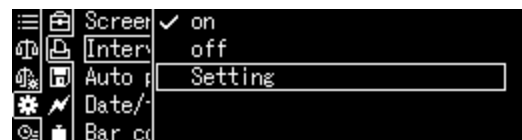

Use the navigation keys to select Interval and confirm using the **OK**-key, selectable 00:00 – 99:59 sec.

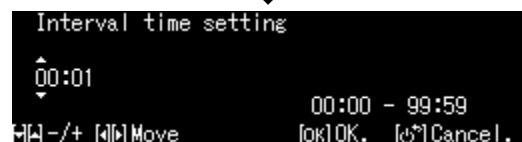

Return to weighing mode

Press the **ON/OFF** button.
From that point onwards continuous data output will be enabled and the indicator  will be displayed.



Place goods to be weighed on balance

- ⇒ If required, place empty container on scale and tare.
- ⇒ Place goods to be weighed on balance
- ⇒ The weighing values are issued according to the defined interval.



Continuous data output may be cancelled and restarted with the help of the **PRINT**-key.

15.8.3 GLP Output Function

With the GLP Output function the printouts of weighing results are completed with a bottom row and a head line. The content of the header and footer are selectable.

Call function:

Press and hold the **CAL**-key for approx. 3 sec.

Confirm <GLP output> by pressing the **OK**-key.

Select Settings <On> and confirm using the **OK**-key.

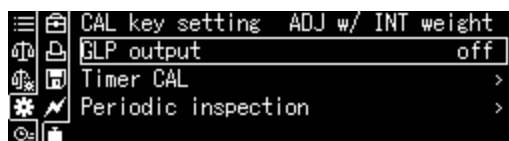

Set output condition:

Use the navigation keys <Setting> and confirm using the **OK**-key.

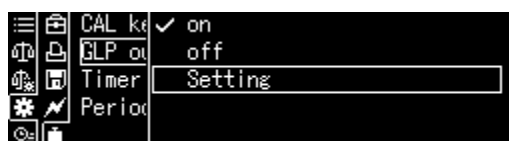

Use the navigation keys to define the contents for the header and footer one by one, each time confirming by pressing the **OK**-key.

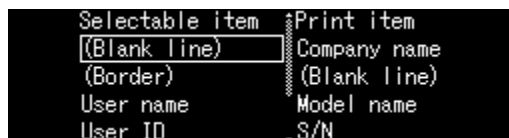

Return to weighing mode

Press the **ON/OFF** button.

- + Enter scale identification number, see chap. 13.3

15.8.4 Defining output details

When the function is enabled you can in addition to weighing value issue the date, time, barcode ID and sample name.

Call function:

Press and hold **PRINT**-key for approx. 3 sec.

Confirm <Printing> by pressing the **OK**-key.



Setting output details:

Use the navigation keys to enable [on] the desired details one by one [on], confirming each time by pressing the OK-key.

- Prints Date/time
- Prints Bar code ident no.
- Prints sample ident number

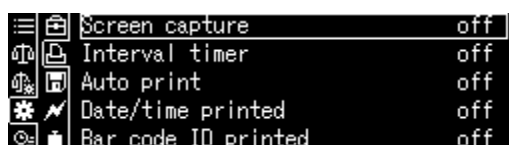

Return to weighing mode: Press the **ON/OFF** button.

Sample log:

----- DATE 2018 Oct. 07 TIME 18:31:34 23456780123456789012 AAAAA0008 175.932[0] g -----	<i>Date</i> <i>Time</i> <i>Barcode ID (max. 22 characters)</i> <i>Sample description</i> <i>Weighing value</i>
---	--

i You may also define the output details via System Settings (See chap. 11.1.3).

The barcode ID may also take place with the help of a barcode reader or a PC keyboard.

15.10 USB connection

The USB interfaces are used to issue adjustment and weighing data. In the same way control commands and data entries may be entered via the connected devices (PC keyboard, barcode reader).





Connecting devices:

After connecting the USB device, connect power supply.
Connecting the USB device later may not work properly



USB connection

USB equipment and application.

			
<p>Save weighing data and adjustment logs</p>	<p>Data input Please refer to below link about recommended keyboard www.kern-sohn.com/Downloads</p>	<p>Data transmission</p>	<p>USB Hub</p>

15.10.1 Edit weighing data, adjustment logs and screenshots to USB medium

+ Preparation

Call function

For calling system settings see chap. 11.1.3

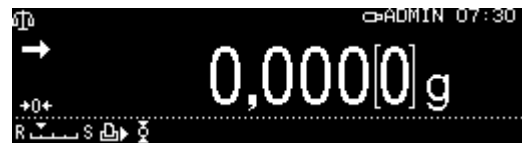

Use the navigation keys \uparrow , \downarrow to select <Setting data backup> and confirm using the **OK**-key.

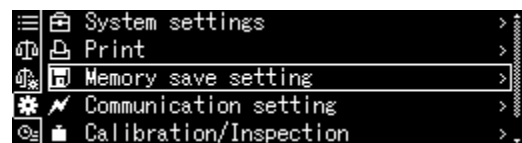

The available menu items will be displayed.

- Save measured records to USB
- Save calibration records to USB
- internal memory output
- USB saved data format

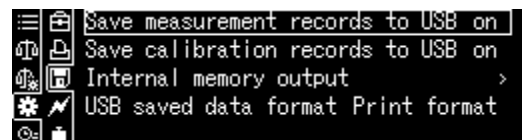

Select file format:

Use the navigation keys to select <USB saved data format> and confirm using the **OK**-key.

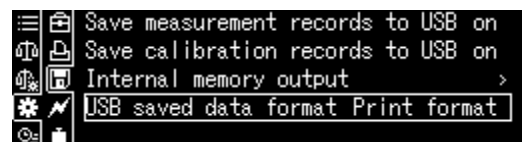

Confirm desired setting by pressing the **OK**-key.

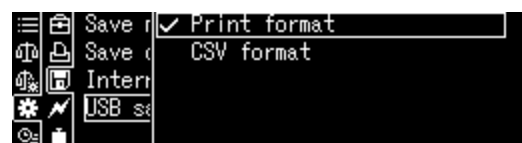

Return to weighing mode: Press the **ON/OFF** button.

+ **Save displayed value as screenshot**

Call System Settings

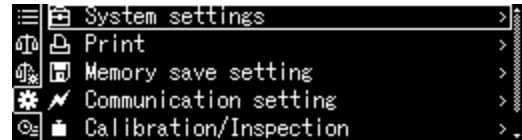
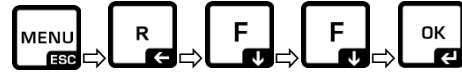

Use the navigation keys to select **↑**, **↓**
<Print> and confirm using the **OK**-key.

or

Press the **PRINT** key long time.



To enable <Screen Capture> select setting
<On> and confirm using the **OK**-key

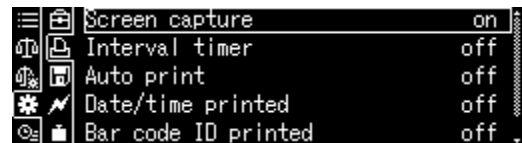

Connect the scale to a USB stick.

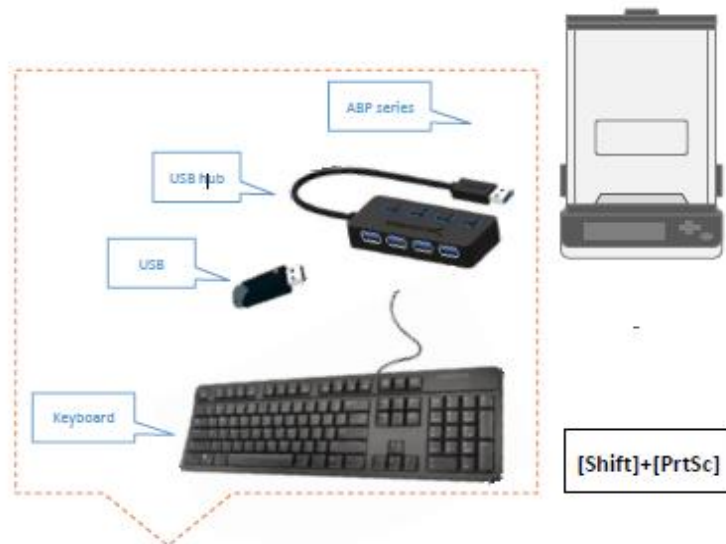

Save screenshot by pressing **PRINT** key

+ **Issue internal memory**

Call Menu Item <Internal memory output> as described above under "Preparation".

Confirm using the **OK**-key

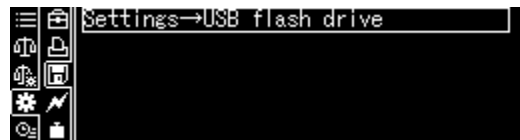
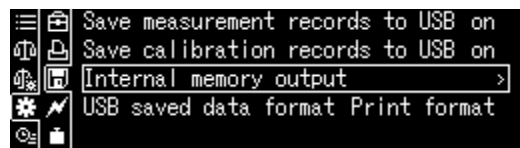

Confirm using the **OK**-key, data will be issued.



Return to weighing mode: Press the **ON/OFF** button.

15.10.2 Data transfer by means of barcode reader

For calling system settings see chap. 11.1.3

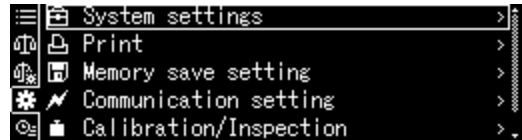

Press **OK** button.



Use the navigation keys **↑**, **↓** to select <Bar code menu> and confirm using the **OK**-key.



The available menu items will be displayed.

- Transfer: All data
- Without commands
- No transmission

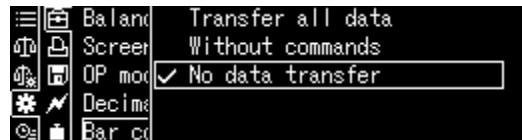

Confirm desired setting by pressing the **OK**-key.

Return to weighing mode: Press the **ON/OFF** button.

Application example for easy log-on (without password entry):

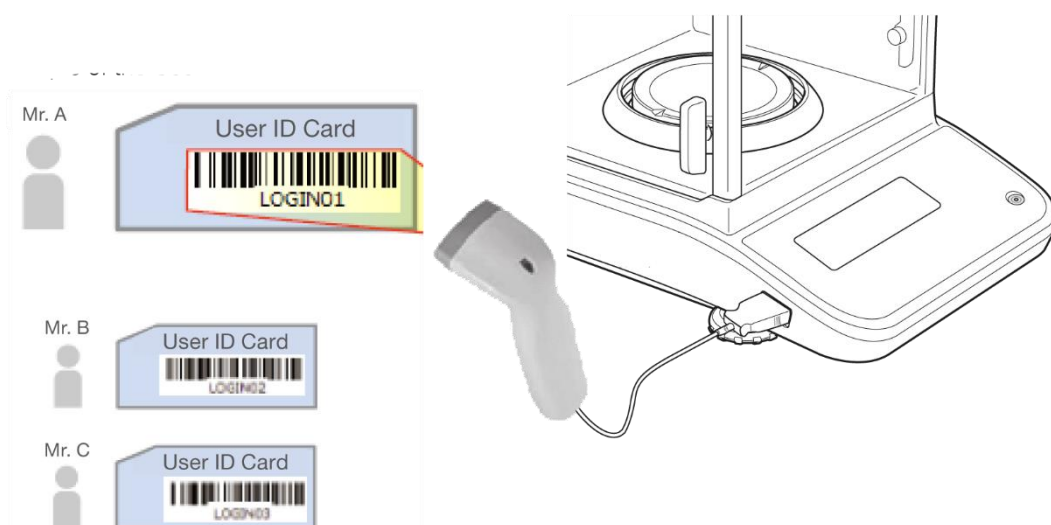

16 Servicing, maintenance, disposal

16.1 Cleaning



Before any maintenance, cleaning and repair work disconnect the appliance from the operating voltage.

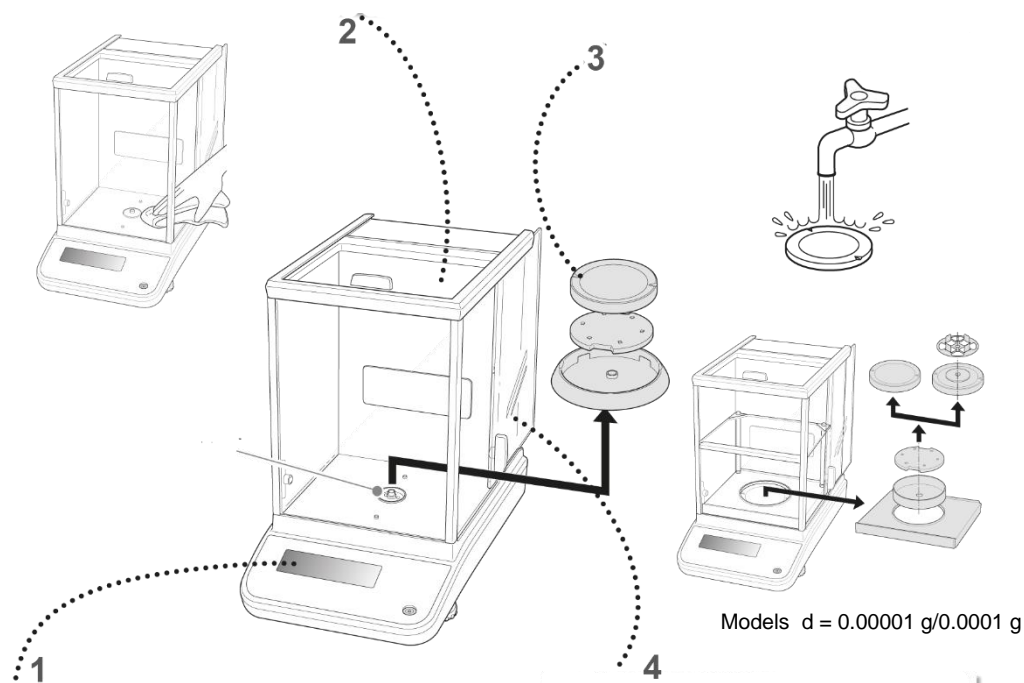

Fig.1: Clean the balance

1. Display

Please do not use aggressive cleaning agents (solvents or similar agents), but a cloth dampened with mild soap suds.

2. Housing

Please do not use aggressive cleaning agents (solvents or similar agents), but a cloth dampened with mild soap suds. Take care that the device is not penetrated by fluids and polish it with a dry soft cloth.

Loose residue sample/powder can be removed carefully with a brush or manual vacuum cleaner.

Spilled weighing goods must be removed immediately.

3. Weighing plate

Remove weighing plate, clean it wet and dry it before installation

4. Glass doors

These may be removed as described below and cleaned with a commercial glass cleaner.

Handle glass doors with care.

Attention: Risk of breakage

Risk of cuts.

Keep away your hands/fingers from the running rail.



1. Remove, screening ring, weighing plate and carrier of weighing plate

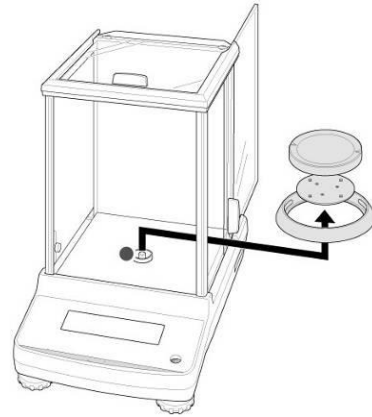

2. Remove the plastic handle by turning.



Do not touch the support of the weighing plate. This could cause damage to the balance.

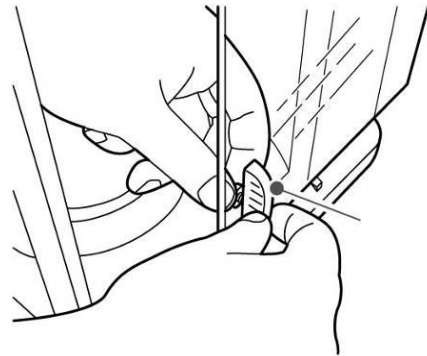

3. Remove glass door carefully acc. to fig.

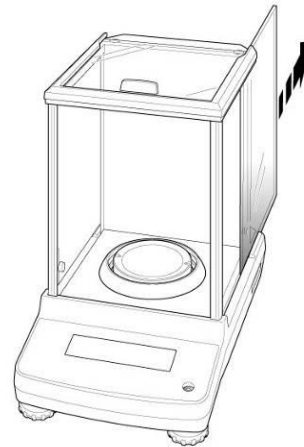

Fig.2: Remove the glass doors

4. Re-install the glass door in reverse order.



To secure the glass doors always reattach the plastic handle.

16.2 Servicing, maintenance

- ⇒ The appliance may only be opened by trained service technicians who are authorized by KERN.
 - ⇒ Before opening, disconnect from power supply.
- TABP-BA-e-2212

16.3 Disposal

Disposal of packaging and appliance must be carried out by operator according to valid national or regional law of the location where the appliance is used.

17 Instant help for troubleshooting

Possible causes of errors:

In case of an error in the program process, briefly turn off the balance and disconnect from power supply. The weighing process must then be restarted from the beginning.

Fault	Possible cause
The weight display does not glow.	<ul style="list-style-type: none">• The balance is not switched on.• The mains supply connection has been interrupted (mains cable not plugged in/faulty).• Power supply interrupted.
The displayed weight is permanently changing	<ul style="list-style-type: none">• Draught/air movement• Glass doors not closed• Table/floor vibrations• Weighing plate has contact with foreign objects.• Electromagnetic fields / static charging (choose different location/switch off interfering device if possible)
The weighing result is obviously incorrect	<ul style="list-style-type: none">• The display of the balance is not at zero• Adjustment is no longer correct.• The balance is on an uneven surface.• Great fluctuations in temperature.• Electromagnetic fields / static charging (choose different location/switch off interfering device if possible)
The desired weighing unit cannot be called by UNIT key.	<ul style="list-style-type: none">• Unit was not activated beforehand.
Automatic adjustment carried out frequently.	<ul style="list-style-type: none">• Severe temperature variations in the room or the instrument
No data transfer between printer and balance.	<ul style="list-style-type: none">• Communication settings are wrong.

The menu settings cannot be changed.

The glass door does not function normally. The error message about the glass door was displayed. (only ABP-A series)

The glass door cannot be closed. Or, it opens immediately right after being closed. (only ABP-A series)

The doors cannot be opened or closed even if the buttons for opening and closing of the doors are pressed or a manual trigger is actuated. (only ABP-A series)

- The menu is locked. Remove the menu lock.
- The current is switched on while a foreign body is stuck in the door or a foreign body during operation has been trapped in the door.
- Opening and closing a glass door could not be triggered because it was actuated manually
- The glass doors were manually quickly opened or closed
- While the glass door was closed, an object hit the door.
- Check whether the glass doors and the stopper knobs are correctly fastened, and switch off and on again the power supply of the balance housing, or initialize the doors automatically.
- When the glass doors or the stopper knobs are loose or missing, re-attach them prior to switching-on the balance.

18 Ionizer









18.1 General hints

The ionizer is available for the ABP-series as Factory Option. In the ABP-A series it is installed as per standard.

The ionizer has conductive peaks supplied by high voltage which, based on corona discharge, generate positively and negatively charged ions in the immediate vicinity. These are attracted by the electrostatic charge of goods to be weighed and, thus, neutralize the interfering electrostatic charge. This also does away with the forces falsifying the weighing (such as falsified weighing result, weighing value drifted).

18.2 Basic Safety Precautions

WARNING

-  The use of ionizer is only intended in combination with electronic weighing balances. Do not use for any other purposes.
-  Never operate the ionizer in explosive environment. The serial version is not explosion protected.
-  Protect the ionizer against high air humidity / temperature, steams and dust;
Take care to select a location free of water and oil
Do not expose the ionizer to strong humidity for extended periods. Non-permitted condensation (condensation of air humidity on the appliance) may occur if a cold appliance is taken to a considerably warmer environment. In this case, acclimatize the disconnected ionizer for ca. 2 hours at room temperature.
-  Whilst the ionizer is switched on, do not touch the ion source; see sticker on the left side.
-  In case of smoke development, smell of fire, strong heating-up of the ionizer or when the red LED starts glowing, turn off the ionizer immediately and disconnect it from the mains.
-  If water or other foreign matter enters the ionizer, turn off the master switch immediately and disconnect it from the mains.
-  On account of the high voltage technology, handle the ion source and exits with care.
-  Do not dismantle or modify the ionizer.



Prevent damage caused by dropping, vibration or shock; see sticker on the left side.



Always use the genuine power pack. The stated voltage value must be the same as the local voltage.



Risk of injury! The peaks of the ion source are very sharp and cutting.



The ionizer generates poisonous ozone; ensure sufficient ventilation.



For maintenance and repair work disconnect the ionizer from the mains.



Disconnect the ionizer from the mains during periods of idleness.



CAUTION



Maintain and clean the ionizer at regular intervals

Clean the ion source: After 1000 hours

Exchange ion source: After 30000 hours



Starting up a damaged ionizer may result in a short circuit, fire or electric shock.



Starting up out of doors and inside vehicles is prohibited and will result in total loss of warranty.



The occurrence of electromagnetic fields may result in major display deviations (incorrect weighing results). Discharge sample at a sufficient distance from the weighing balance.



During normal operation the green LED [POWER], will be glowing, in case of a breakdown the red LED [ALARM].

If the red LED is glowing, turn off the ionizer at the master switch and turn it on again. If the red LED continues to glow, inform the manufacturer.

During ionization the blue LED [RUN] is lighting.



During ionization an operation noise is audible.

18.3 Technical data

Technology	AC Corona discharge
Discharge time ($\pm 1000V \rightarrow \pm 100V$)	1 second
Ozone concentration	0.06ppm (150 mm from ion source)
Environmental conditions	0- 40 °C, 25 – 80 % air humidity (non-condensing)
Electric Supply	Mains adapter: Input AC 100V - 240V, 0.58 A, 50 - 60 Hz Output DC 24V, 1 A Ionizer: 200 mA
Degree of pollution	2
Overvoltage category	Category II
Place of installation	In sealed rooms only

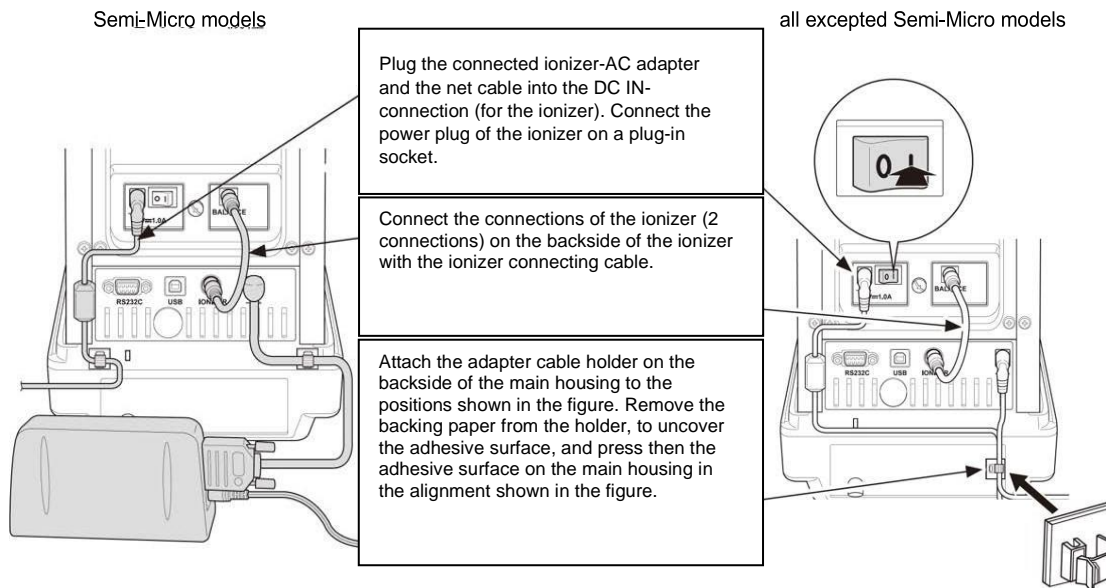

18.4 Commissioning

Switch on balance

Connect network adapter of ionizer to scale, as shown on diagram.

Connect network adapter of ionizer to power supply.

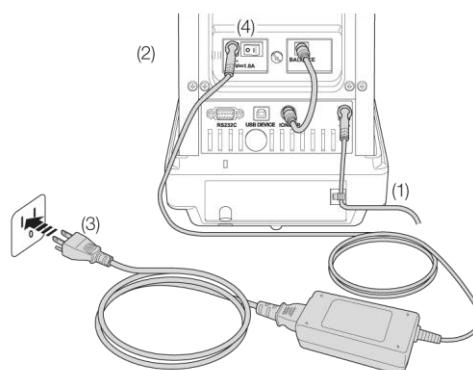

Turn on ionizer as shown on diagram [on].

The display  will light up.
(only ABP series)

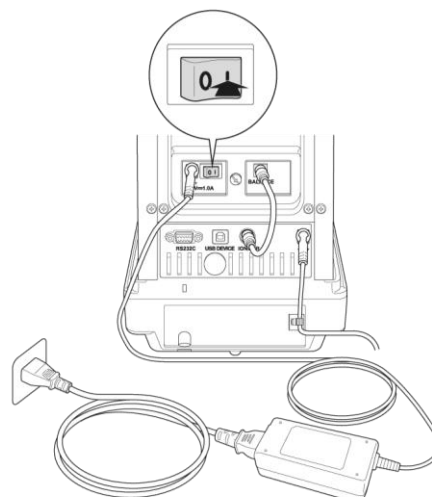

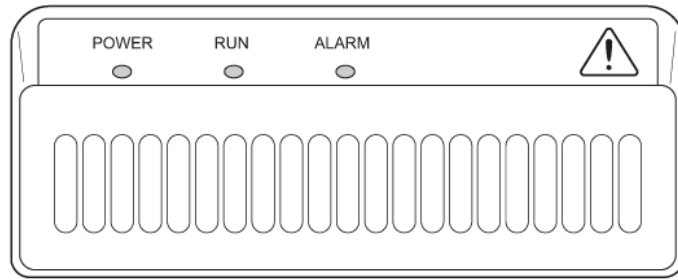

Ionization

Make sure that the green LED [Power] is lighting.



Close windshield doors.



Press -button (ABP) / -button (ABP-A), ionization is started. During ionization the blue LED [RUN] is lighting. The length of time depends on the menu setting <System Settings → Ion irradiation time>.

Set irradiation time for ions

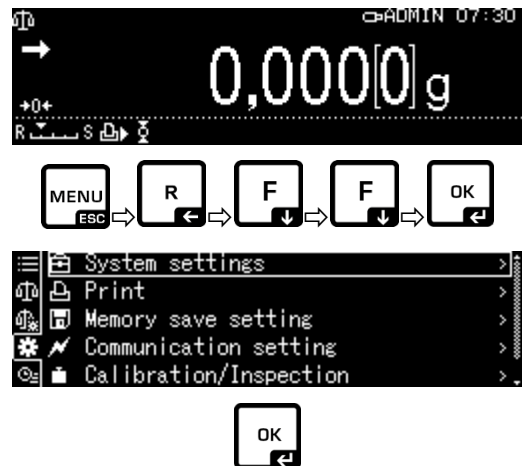
For calling system settings see chap. 11.1.3



Press **OK** button.

Use the navigation keys to ,  to select <Ion irradiation time> and confirm using the **OK**-key.



Confirm desired setting by pressing the **OK**-key.

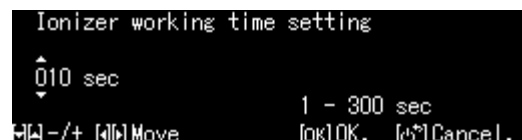





Return to weighing mode:

Press the **ON/OFF** button.

18.5 Maintenance & Cleaning

- i** Maintain and clean the ionizer at regular intervals
Clean the ion source: After 1000 hours
Exchange ion source: After 30000 hours

 WARNING	
	Disconnect the device from mains before cleaning.
	Do not dismantle the ionizer.
	Clean the ion source with care. Take care that the peaks are not bent.

Cleaning

To clean the housing, do not use aggressive cleaning agents (solvents etc.) instead clean with a soft cloth soaked in mild soap suds. Take care that the device is not penetrated by fluids and polish it with a dry soft cloth.

Remove loose sample residues / powder carefully with the help of a brush or hand-held vacuum cleaner.

To clean the ion source use the delivered cleaning brush or a cotton stick moistened with alcohol. Take care that the peaks are not bent.

Remove loosely attached dust with compressed air.

→