



**KERN & Sohn GmbH**

Ziegelei 1  
D-72336 Balingen  
E-Mail: [info@kern-sohn.com](mailto:info@kern-sohn.com)

Phone: +49-[0]7433- 9933-0  
Fax: +49-[0]7433-9933-149  
Internet: [www.kern-sohn.com](http://www.kern-sohn.com)

# Installation Instructions

## Weighing beams

### **KERN KFA V20**

Version 1.4  
02/2017  
GB



KFA V20-IA-e-1714



# KERN KFA V20

Version 1.4 02/2017

## Installation Instructions Weighing beams

### Contents

<b>1</b>	<b>Technical data</b> .....	<b>3</b>
<b>2</b>	<b>Appliance overview</b> .....	<b>4</b>
<b>3</b>	<b>Basic Information (General)</b> .....	<b>5</b>
3.1	Documentation .....	5
3.2	Proper use .....	5
3.3	Improper Use .....	5
3.4	Warranty .....	5
3.5	Monitoring of Test Resources .....	6
<b>4</b>	<b>Basic Safety Precautions</b> .....	<b>6</b>
4.1	Pay attention to the instructions in the Operation Manual.....	6
4.2	Personnel training.....	6
<b>5</b>	<b>Transport and storage</b> .....	<b>6</b>
5.1	Testing upon acceptance .....	6
5.2	Packaging / return transport .....	6
<b>6</b>	<b>Unpacking, Setup and Commissioning</b> .....	<b>7</b>
6.1	Installation Site, Location of Use .....	7
6.2	Unpacking and placing .....	8
6.3	Connecting a display screen .....	9
<b>7</b>	<b>Operation</b> .....	<b>9</b>
7.1	Load/unload weighing beams.....	10
<b>8</b>	<b>Service, maintenance, disposal</b> .....	<b>11</b>
8.1	Daily check .....	11
8.2	Cleaning .....	11
8.3	Service, maintenance .....	11
8.4	Disposal.....	11
8.5	Instant help .....	12
<b>9</b>	<b>Service documentation</b> .....	<b>13</b>
9.1	Overview, setting regulation, tolerances .....	13
9.2	Check and adjustment of the corner load.....	14
<b>10</b>	<b>Dimensioned drawings</b> .....	<b>15</b>
<b>11</b>	<b>Deadload settings</b> .....	<b>19</b>

## 1 Technical data

Model	Weighing range Max kg	Readability d kg	Preload additive kg	Cable length display screen approx. m	Connecting cable weighing beams approx. m	Net weight approx. kg	Dimensions weighing plate W x D x H mm
KFA 600V20S	600	0.2	120	5	2.5	25	800x120x80
KFA 1500V20	1500	0.5	300	5	2.5	36	1200x120x100
KFA 3000V20	3000	1	500	5	2.5	36	1200x120x100
KFA 3000V20L	3000	1	500	5	1.5	65	2000x120x100
KFA 6000V20	6000	2	1000	5	1.5	85	1200x160x80
KFA 6000V20L	6000	2	1000	5	1.5	125	2100x160x85

## 2 Appliance overview



Illustrative example weighing system KERN KFA V20 + KFB-TM

- ❶ Mains lead display screen
- ❷ Connecting cable weighing beams
- ❸ Handle for easy transport
- ❹ Weighing cell feet and weighing cells
- ❺ Cover adjusting screw for weighing cell feet

### 3 Basic Information (General)

#### 3.1 Documentation

These installation instructions contain all data necessary for placing and commissioning the weighing beams KERN KFA V20.

In combination with a display unit, described below as weighing system, for operation configuration, please refer to the operating instructions of the display unit.

#### 3.2 Proper use

The weighing beams are designed for weighing of large, voluminous or long loads. They are designed to be used as “non-automatic scales“. As soon as a stable weighing value is reached the weighing value can be read.

#### 3.3 Improper Use

Do not leave loads permanently on the weighing beams. This may damage the measuring system.

Impacts and overloading exceeding the stated maximum load (max) of the weighing beams, minus a possibly existing tare load, must be strictly avoided. This may damage the weighing beams.

Never operate in an explosive environment. The serial version is not explosion protected.

Do not modify the construction of the weighing beams. This may lead to incorrect weighing results, safety-related faults and destruction of the weighing beams.

The weighing beams may only be used according to the described conditions. Other areas of use must be released by KERN in writing.

#### 3.4 Warranty

Warranty claims shall be voided in case

- Our conditions in the operation manual are ignored
- The appliance is used outside the described uses
- Structural changes of the device
- Mechanical damage and damage caused by media, liquids
- Natural wear and tear
- The appliance is improperly set up or incorrectly electrically connected
- Overload of the measuring system

### 3.5 Monitoring of Test Resources

In the framework of quality assurance the measuring-related properties of the weighing system and, if applicable, the testing weight, must be checked regularly. The responsible user must define a suitable interval as well as type and scope of this test. Information is available on KERN's home page ([www.kern-sohn.com](http://www.kern-sohn.com)) with regard to the monitoring of weighing system test substances and the test weights required for this. In KERN's accredited DKD calibration laboratory test weights and weighing systems may be calibrated (return to the national standard) fast and at moderate cost.

## 4 Basic Safety Precautions

### 4.1 Pay attention to the instructions in the Operation Manual



Carefully read this operation manual before setup and commissioning, even if you are already familiar with KERN balances.

### 4.2 Personnel training

The appliance may only be operated and maintained by trained personnel. The installation of a display unit must only be carried out by a well acquainted specialist with the workings of weighing balances.

## 5 Transport and storage

### 5.1 Testing upon acceptance

When receiving the appliance, please check packaging immediately, and the appliance itself when unpacking for possible visible damage.

### 5.2 Packaging / return transport



- ⇒ Keep all parts of the original packaging for a possibly required return.
- ⇒ Only use original packaging for returning.
- ⇒ Prior to dispatch disconnect all cables and remove loose/mobile parts.
- ⇒ Reattach possibly supplied transport securing devices.
- ⇒ Secure all parts against shifting and damage.

## 6 Unpacking, Setup and Commissioning

### 6.1 Installation Site, Location of Use

The weighing beams are designed in a way that reliable weighing results are achieved in common conditions of use.

To enable exact and fast work, select the right site.

**On the installation site observe the following:**

- Place the weigh beam on a level and stable surface.  
The foundations at the site must be able to bear the weight of the weighing beams as well as the weight of the maximum weight.
- Avoid extreme heat as well as temperature fluctuation caused by installing next to a radiator or in the direct sunlight
- Protect the weighing system against direct draughts due to open windows and doors
- Avoid jarring during weighing
- Protect the weighing beams against high humidity, vapours and dust
- Do not expose weighing beams to moisture over a long period of time. Non-permitted condensation (condensation of air humidity on the appliance) may occur if a cold appliance is taken to a considerably warmer environment. In this case, acclimatize the disconnected appliance for ca. 2 hours at room temperature
- Avoid static charge of goods to be weighed or weighing container
- Do not lean weighing beams against a wall
- Do not move weighing beams whilst loaded
- Keep away chemicals (such as liquids or gasses), which could attack and damage the weighing beams inside or from outside
- Keep IP protection of the device

Major display deviations (incorrect weighing results) may be experienced should electromagnetic fields (e.g. due to mobile phones or radio equipment), static electricity accumulations or instable power supply occur. Change location or remove source of interference.

## 6.2 Unpacking and placing

### Unpacking:

Remove weighing beams and accessories carefully from packaging, remove packaging material and place device at the planned work place. Verify that there has been no damage and that all packing items are present.

### Scope of delivery:

- 2 Weighing beams with fitted “mains lead display screen“ and “connecting cable weighing beams”.
- 4 weighing cell feet
- Operating instructions

### Placing:

- ⇒ Prior to the final placing, install the four weighing cell feet.
- ⇒ Ensure a level surface on the installation site, particularly around the weighing cell feet.
- ⇒ Put down the weighing beams and check whether they are positioned level and that all four feet reach the floor. Adjust minor height differences by adjusting the weighing cell feet.
- ⇒ For this purpose remove the cap head screw (See chapter 2, item ⑤ ) and adjust the height of the 4 weighing cells by turning the adjusting screw. For this purpose use an external levelling appliance, e.g. a water level.
- ⇒ Make sure not to crimp or damage the mains lead and connecting cable when lifting or placing.



### 6.3 Connecting a display screen

#### Attention

Put the connecting cable to the display unit in a manner that it is protected against damage.

#### Description of the connection cable:

terminal	Color	State
EXC+ [IN+]	red	voltage +
SIG + [OUT+]	green	signal +
SIG -[OUT-]	white	signal -
EXC -[IN- ]	black	voltage -

## 7 Operation

Information about

- **Network connection**  
Power is supplied via the connecting cable of the display unit
- **Initial Commissioning**
- **Connection of peripheral devices**

and the correct operation you will in the operating instructions included in the scope of delivery of the display unit.

## 7.1 Load/unload weighing beams

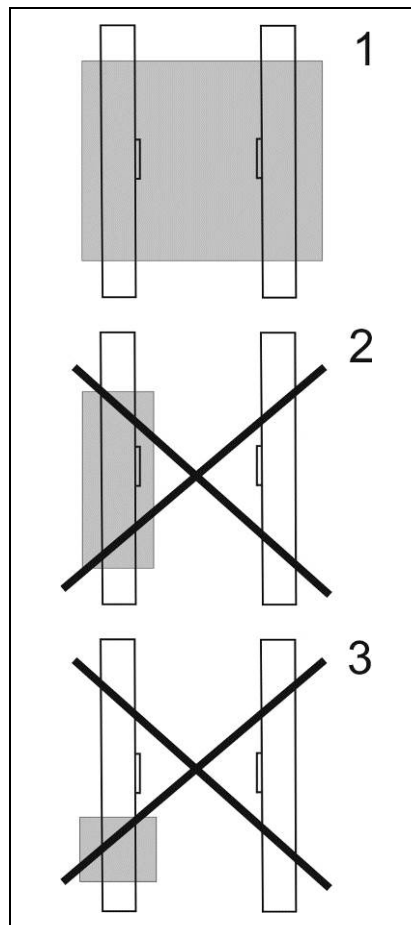

- The weighing beams are designed for an evenly spread load

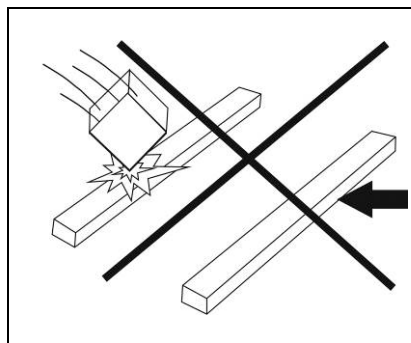

- Avoid falling load, shock loads and impacts from the side.
  - Weighing beams must not be moved when loaded.
- ⇒ Place the load onto **both** weighing beams by using a pallet truck, crane or fork lift. Ensure that the load is not swinging when it is placed onto the weighing beams.
- ⇒ Lift the load first vertically at least 10 cm above the weighing beams before it is removed or newly placed.

## 8 Service, maintenance, disposal



Before any maintenance, cleaning and repair work disconnect the appliance from the operating voltage.

### 8.1 Daily check

- ⇒ Ensure that all four feet are in contact with the floor.
- ⇒ Ensure that cables are not damaged.
- ⇒ Ensure that the weighing beams are free of soiling, in particular underneath the edges.

### 8.2 Cleaning

⚠ Remove regularly corrosive substances.

⚠ Keep IP protection.

⚠ Do not aim water or steam jet at the weigh cells.

- ⇒ Clean weighing beams using a soft cloth soaked in a mild detergent. Take care that the device is not penetrated by fluids and polish it with a dry soft cloth.

### 8.3 Service, maintenance

- ⇒ The appliance may only be opened by trained service technicians who are authorized by KERN.
- ⇒ Ensure that the weighing system is regularly calibrated, see chap. 3.5 Testing instruments control.

### 8.4 Disposal

- ⇒ Disposal of packaging and appliance must be carried out by operator according to valid national or regional law of the location where the appliance is used.

## 8.5 Instant help

In case of an error in the program process, briefly turn off the weighing system and disconnect from power supply. The weighing process must then be restarted from the beginning.

Help:

### Fault

The displayed weight is permanently changing

### Possible cause

- Draught/air movement
- Floor vibrations
- Weighing beams come into contact with foreign substances.
- Electromagnetic fields / static charging (choose different location/switch off interfering device if possible)

The weighing result is obviously incorrect

- No zero display for unloaded weighing beams.
- Adjustment is no longer correct.
- Great fluctuations in temperature.
- The weighing beams are not level.
- Electromagnetic fields / static charging (choose different location/switch off interfering device if possible)

Should other error messages occur, switch balance off and then on again. If the error message remains inform manufacturer.

## 9 Service documentation

- i** • This chapter is only intended for a balance specialist!
- The weighing beams are fitted with a DMS weigh cell at each corner.
- The analogue-digital transformation occurs in the display unit. Also all the balance and country-specific data are stored there.

### 9.1 Overview, setting regulation, tolerances

#### Testing and setting regulations:

Capacity	600 kg	1500 kg
Readability	200 g	500 g
Min	4 kg	10 kg
Max	600 kg	1500 kg
1/3 corner load	200 kg	500 kg
Tolerance	200 g	500 g

#### Verification data and tolerances as per OIML:

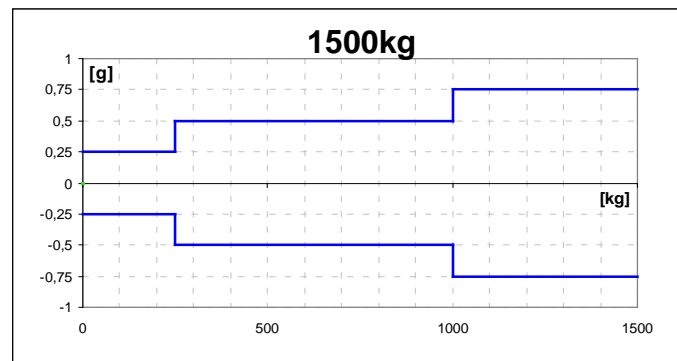
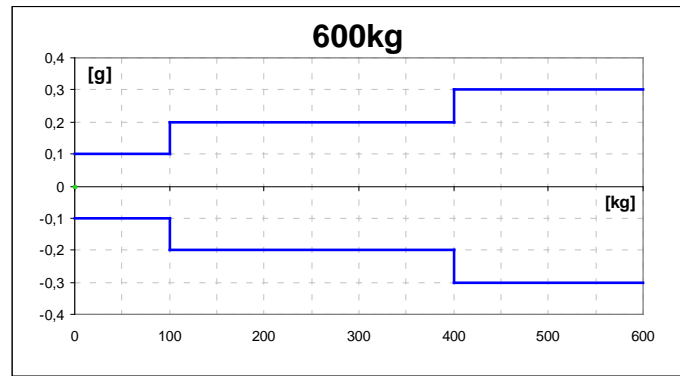

## 9.2 Check and adjustment of the corner load

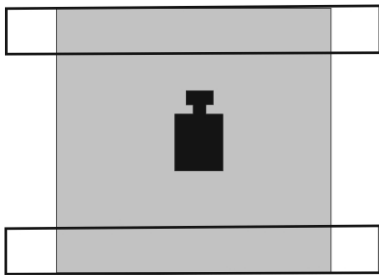

0.00 kg

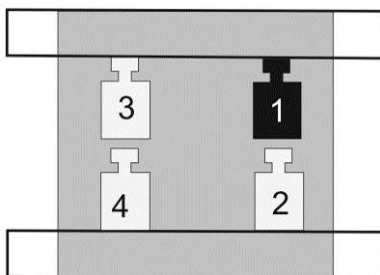
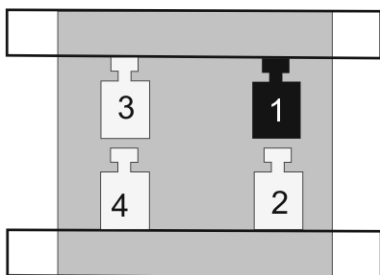

### Check of the corner load:

- Place a suitable aid such as a pallet on both weighing beams. Make sure that the aid is designed to bear the weight of the test weight.
- Place the test weights in the centre of the load plate and tare.
- The balance displays -0-.
- Place the test weights successively on all four corners.
- Now the deviations are displayed with sign, write down the values. If there are deviations out of the tolerances (see chap. 9.1), an adjustment will be necessary.

### Adjustment of corner load:

Preparation:

- For a better control of the modifications which occur during adjustment, select in the configuration menu the highest readability for control purposes.
- Open connection box

Adjustment rule:

The corner (weighing cell) with the biggest negative deviation must be set to zero. Do not re-adjust this corner even after several adjustment sequences.

### Adjustment on the analogue print

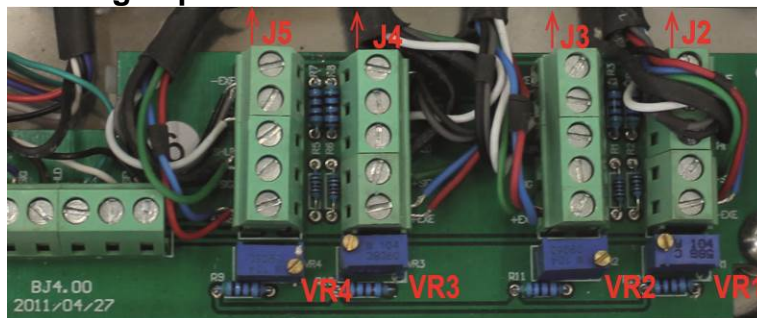

Adjustment of weighing cell J2 takes place at the potentiometer VR1.  
Adjustment of weighing cell J3 takes place at the potentiometer VR2.  
Adjustment of weighing cell J4 takes place at the potentiometer VR3.  
Adjustment of weighing cell J5 takes place at the potentiometer VR4.  
Increase the value turning to the right, reduce the value turning to the left.

## 10 Dimensioned drawings

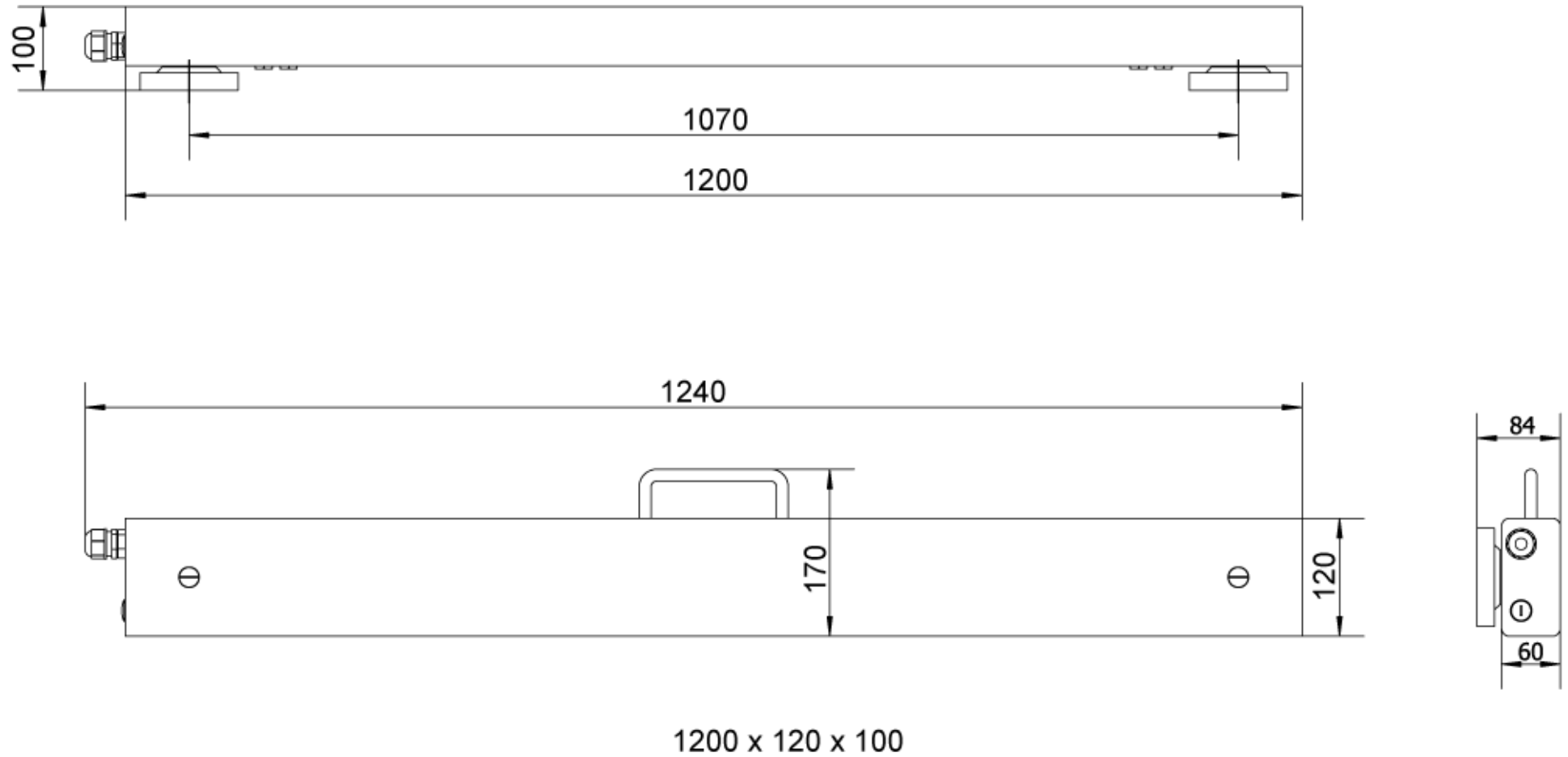

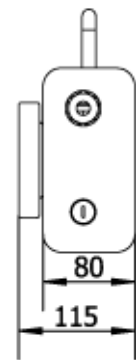
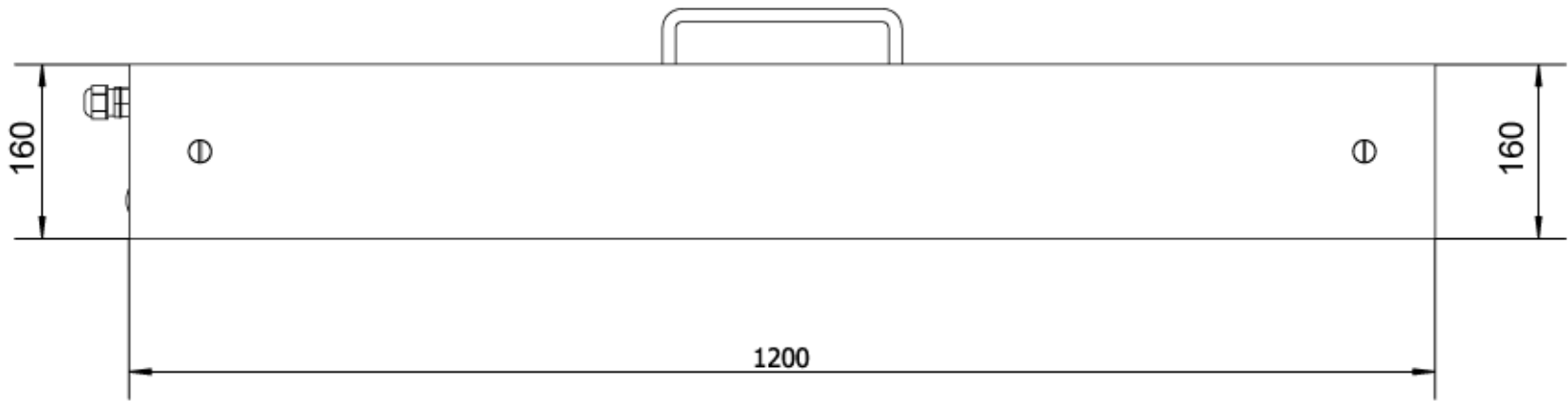
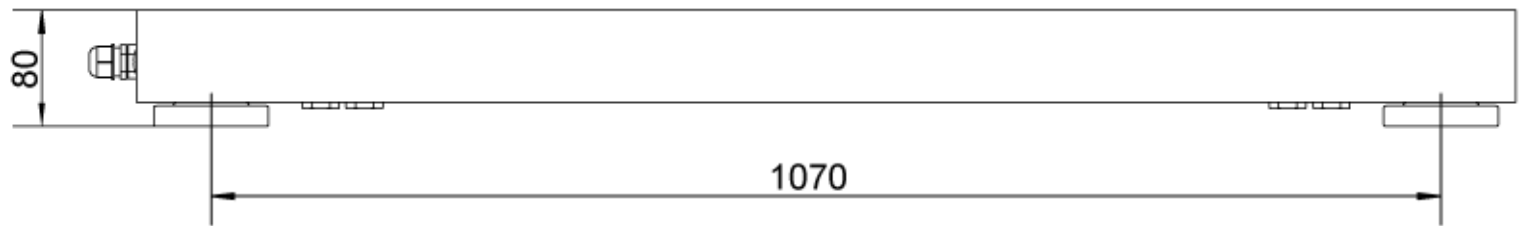

1200 x 160 x 80



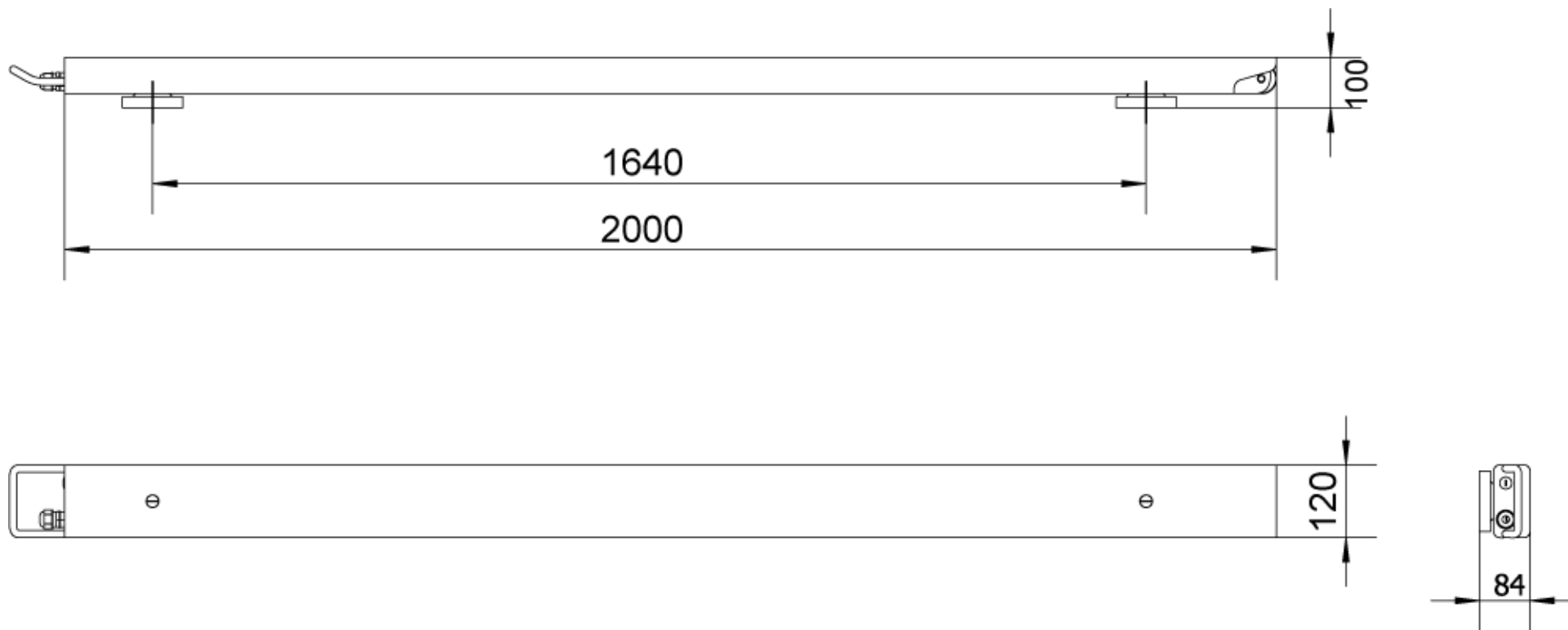

2000 x 120 x 100

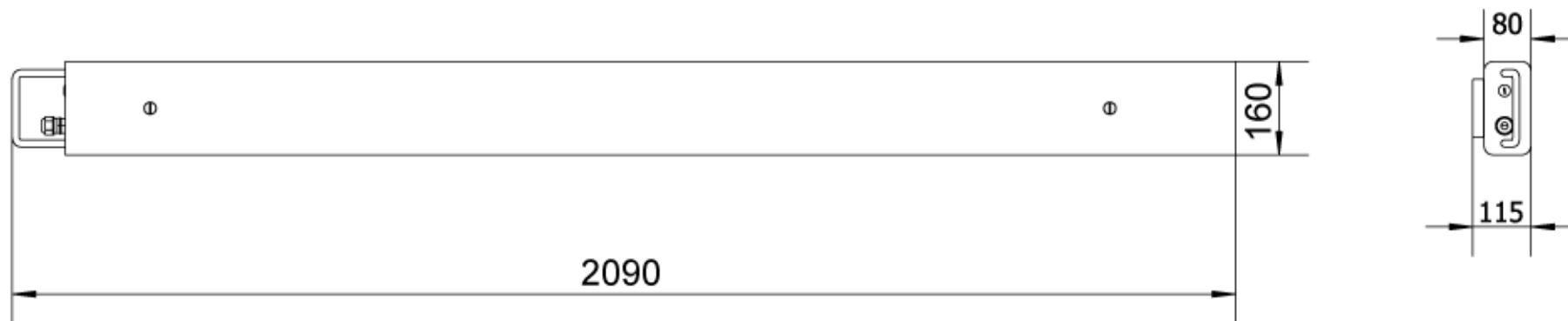
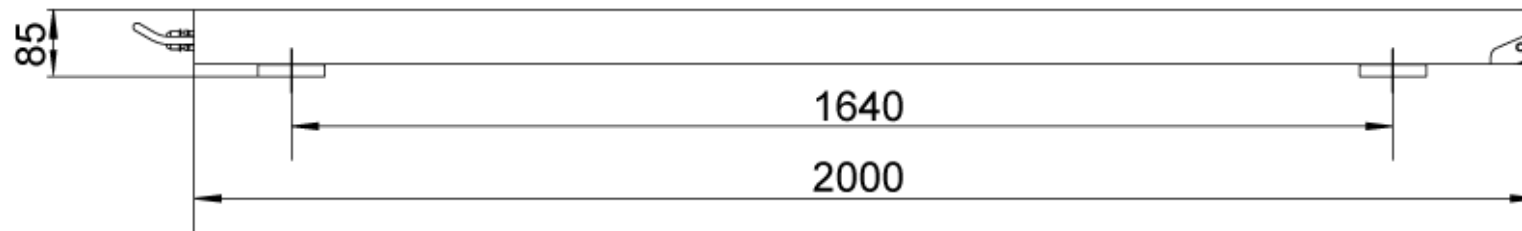

2000 x 160 x 85

## 11 Deadload settings

<b>Kern model</b>	<b>Deadload** (kg)</b> **= already applied preload	<b>Center Overload Protection circa (kg)</b>	<b>Corner Overload Protection circa (kg)</b>	<b>Loadcell Capacity (kg)</b>
KFA 600V20S	30	NA	NA	600kg
KFA 1500V20	39	NA	NA	1000kg
KFA 3000V20	39	NA	NA	1500kg
KFA 3000V20L	55	NA	NA	1500kg
KFA 6000V20	85	NA	NA	3000kg
KFA 6000V20L	95	NA	NA	3000kg

<b>Platform type</b>	<b>Platform dimension (mm)</b>	<b>Load cell Type</b>	<b>TC No.</b>	<b>Class</b>	<b>E<sub>max</sub></b> <b>-1 (kg)</b>	<b>E<sub>min</sub></b> <b>-4 (g)</b>	<b>Y</b>	<b>n</b> <b>-3</b>	<b>Deadload (kg)</b>	<b>T<sub>min</sub></b> <b>-5</b>	<b>T<sub>max</sub></b> <b>-6</b>
KFA 600V20S	800 x120	H8C	TC8012	C3	600	0	20000	5000	30	-10	40
KFA 1500V20	1200x120	SQB	TC6911	C3	1000	0	10000	3000	36	-10	40
KFA 3000V20	1200x120	SQB	TC6911	C3	1500	0	10000	3000	36	-10	40
KFA 3000V20L	2000x120	SQB	TC6911	C3	1500	0	10000	3000	55	-10	40
KFA 6000V20	1200x120	SQB	TC6911	C3	3000	0	10000	3000	85	-10	40
KFA 6000V20L	2000x120	SQB	TC6911	C3	3000	0	10000	3000	95	-10	40