



KERN & Sohn GmbH

Ziegelei 1
D-72336 Balingen
E-mail: info@kern-sohn.com

Phone: +49-[0]7433-9933-0
Fax: +49-[0]7433-9933-149
www.kern-sohn.com

Operating manual

Analytical and precision balances

KERN ALJ/ALS/PLJ/PLS

Type TALJG-A / TALSG-A / TPLJG-A / TPLSG-A

Version 1.2

2021-06

GB



TALJG_A/TALSG_A/TPLJG_A/TPLSG_A-BA-e-2112



KERN ALJ/ALS/PLJ/PLS

Version 1.2 2021-06

Operating manual

Analytical and precision balances

Contents

1	Technical specification	5
2	Declaration of Conformity	15
3	Device overview	16
3.1	Parts	16
3.2	Operating controls	20
3.2.1	Keyboard overview	20
3.2.2	Navigation buttons / Introducing the numerical value	21
3.3	Display overview	22
3.4	User interface	23
4	Basic instructions.....	24
4.1	Intended use	24
4.2	Non-intended use	24
4.3	Warranty	24
4.4	Testing equipment supervision	24
5	Basic safety instructions	25
5.1	Compliance with the instructions included in the user manual.....	25
5.2	Personnel training.....	25
6	Transport and storage.....	25
6.1	Checking during reception	25
6.2	Packaging / return transport.....	25
7	Unpacking, positioning and start-up.....	28
7.1	Installation place, operation place	28
7.2	Unpacking and check.....	29
7.2.1	Setting.....	29
7.3	Power supply	33
7.4	Operation with battery supply (solely the model PLS 420-3F)	33
7.5	Operator language selection	34
7.6	Connecting peripherals	34
8	Adjustment	34
8.1	Adjustment mode selection	35
8.2	Automatic adjustment using the internal weight	36
8.3	Adjustment using the internal weight after the Model CAL button is pressed (models ALJ/PLJ)	37
8.4	Adjustment using the external weight.....	38
8.5	Changing the weight of the internal calibration weight.....	39
8.6	Adjustment report display/print.....	40
8.7	Verification	41
9	Basic mode.....	42

9.1	Switching the scale on and off	42
9.2	Resetting	42
9.3	Ordinary weighing	43
9.4	Weighing range indicator	43
9.5	Taring	44
9.6	Weighing using the under-scales weighing hanger	45
11	Setup menu	46
11.1	Weight units (unit1/unit2)	49
11.2	RS-232	50
11.3	Transmission speed.....	51
11.4	Auto zero	52
11.5	Filter	53
11.6	Stability	53
11.7	Setting the display contrast	54
11.8	Display backlight.....	55
11.9	Automatic switch-off function	55
11.10	Setting time and date	56
11.11	User interface language	57
12	Main menu “Applications”	58
12.1	Counting the number of pieces	59
12.1.1	Determining the reference value by weighing	59
12.1.2	Introducing the reference weight in the numerical value	62
12.1.3	Automatic optimization of the reference value	63
12.2	Determining density using the equipment for the under-scales weighing hanger	64
12.2.1	Determining solid body density using the equipment for the under-scales weighing hanger 64	
12.2.2	Liquid density determination	68
12.3	Formulation.....	70
12.3.1	Free formulation	70
12.3.1	Formulation defining and implementation	72
12.4	Test weighing	81
12.5	Determining the percentage value	84
12.5.1	Entering the reference weight by weighing	84
12.5.2	Introducing the reference weight in the numerical value	85
12.6	Weighing animals	86
12.7	Peak value function	87
12.8	GLP function (Good Laboratory Practice)	88
13	RS-232C interface	90
13.1	Technical specification.....	90
13.2	Use of the scale plug pins	90
13.3	Interface.....	91
13.3.1	Printer connection	92
13.4	Data transmission	92
13.5	Data transmission formats	92
13.6	Remote control command.....	94
14	Error messages.....	95
15	Maintenance, service and disposal.....	95
15.1	Cleaning	95
15.2	Maintenance and service	95

15.3 Disposal.....96

16 Help for any minor failures 96

17 Ionizing unit (factory option for KERN ALJ-A03) 97

17.1 General information97

17.2 Basic safety instructions97

17.3 Technical specification.....99

17.4 Device overview.....99

17.5 Start.....100

17.6 Intended use.....101

17.7 Cleaning101

1 Technical specification

KERN	ALJ 160-4A	ALJ 210-5A	ALJ 200-5DA
Product number / type	TALJG 160-4-A	TALJG 210-5-A	TALJG 220-5-A
Weighing range (<i>Max</i>)	160 g	210 g	82 g/220 g
Interval (<i>d</i>)	0.1 mg	0.01 mg	0.01 mg/0.1 mg
Reproducibility	0.1 mg	0.05 mg	0.04 mg/0.1 mg
Linearity	±0.3 mg	± 0.1 mg	±0.1 mg/0.2 mg
Settling time (standard)	4 s	6 sec.	10 s
Minimum part weight when counting the number of pieces in laboratory conditions*	1 mg	1 mg	1 mg
Minimum part weight when counting the number of pieces in standard conditions**	10 mg	10 mg	10 mg
Heating time	8 h		
Adjustment weight	internal		
Number of reference pieces when counting the number of pieces	10, 25, 50, 100, selected freely		
Weight units	ct, g, gn, lb, mo, oz, ozt, tl (Hong Kong), tl (Singapore, Malaysia), tl (Taiwan), pen		
Power supply	24 V DC, 1A		
Operating temperature	+15°C ... +30°C		
Air humidity	max. 80% (non-condensing)		
Housing (W × D × H) mm	210 × 340 × 330		
Wind breaker dimensions (W × D × H) mm	160 × 140 × 205 (inner) 190 × 195 × 225 (outer)	160 × 170 × 225 (inner) 172 × 185 × 245 (outer)	160 × 170 × 225 (inner) 190 × 195 × 225 (outer)
Scale plate (stainless steel)	Ø 80 mm		
(Net) weight kg	6.5 kg		7 kg
Interface	RS-232C		
Contamination degree	2		
Overvoltage category	Category II		
Installation height above sea level	up to 4000 m		
Location site	Solely indoors		

KERN	ALJ 250-4A	ALJ 310-4A	ALJ 500-4A
Product number / type	TALJG 250-4-A	TALJG 310-4-A	TALJG 510-4-A
Weighing range (<i>Max</i>)	250 g	310 g	510 g
Interval (<i>d</i>)	0.1 mg	0.1 mg	0.1 mg
Reproducibility	0.1 mg	0.1 mg	0.2 mg
Linearity	±0.3 mg	±0,3 mg	±0,4 mg
Settling time (standard)	4 s	4 s	4 s
Minimum part weight when counting the number of pieces in laboratory conditions*	1 mg	1 mg	1 mg
Minimum part weight when counting the number of pieces in standard conditions**	10 mg	10 mg	10 mg
Heating time	8 h		
Adjustment weight	internal		
Number of reference pieces when counting the number of pieces	10, 25, 50, 100, selected freely		
Weight units	ct, g, gn, lb, mo, oz, ozt, tl (Hong Kong), tl (Singapore, Malaysia), tl (Taiwan), pen		
Power supply	24 V DC, 1A		
Operating temperature	+5°C ... +30°C		
Air humidity	max. 80% (non-condensing)		
Housing (W × D × H) mm	210 × 340 × 330		
Wind breaker dimensions (W × D × H) mm	160 × 140 × 205 (inner) 190 × 195 × 225 (outer)		
Scale plate (stainless steel)	Ø 80 mm		
(Net) weight kg	6.5 kg		
Interface	RS-232C		
Contamination degree	2		
Overvoltage category	Category II		
Installation height above sea level	up to 4000 m		
Location site	Solely indoors		

KERN	ALJ 160-4AM	ALJ 250-4AM
Product number / type	TALJG 160-4M-A	TALJG 250-4M-A
Weighing range (<i>Max</i>)	160 g	250 g
Interval (<i>d</i>)	0.1 mg	0.1 mg
Reproducibility	0.1 mg	0.1 mg
Linearity	±0.3 mg	±0,3 mg
Verification scale interval (<i>e</i>)	1 mg	1 mg
Verification class	I	I
Minimum weight (<i>Min</i>)	10 mg	10 mg
Settling time (standard)	4 s	4 s
Minimum part weight when counting the number of pieces in laboratory conditions*	1 mg	1 mg
Minimum part weight when counting the number of pieces in standard conditions**	10 mg	10 mg
Heating time	8 h	
Adjustment weight	internal	
Number of reference pieces when counting the number of pieces	10, 25, 50, 100, selected freely	
Weight units	ct, g	
Power supply	24 V DC, 1A	
Operating temperature	+15°C ... +30°C	
Air humidity	max. 80% (non-condensing)	
Housing (W × D × H) mm	210 × 340 × 330	
Wind breaker dimensions (W × D × H) mm	160 × 140 × 205 (inner) 190 × 195 × 225 (outer)	
Scale plate (stainless steel)	Ø 80 mm	
(Net) weight kg	6,5	
Interface	RS-232C	
Contamination degree	2	
Overvoltage category	Category II	
Installation height above sea level	up to 4000 m	
Location site	Solely indoors	

KERN	ALS 160-4A	ALS 250-4A
Product number / type	TALSG 160-4-A	TALSG 250-4-A
Weighing range (<i>Max</i>)	160 g	250 g
Interval (<i>d</i>)	0.1 mg	0.1 mg
Reproducibility	0.1 mg	0.1 mg
Linearity	±0.3 mg	±0,3 mg
Settling time (standard)	4 s	4 s
Minimum part weight when counting the number of pieces in laboratory conditions**	1 mg	1 mg
Minimum part weight when counting the number of pieces in standard conditions**	10 mg	10 mg
Heating time	8 h	
Recommended adjustment weight (class), not delivered	150 g (E2)	250 g (E2)
Number of reference pieces when counting the number of pieces	10, 25, 50, 100, selected freely	
Weight units	ct, g, gn, lb, mo, oz, ozt, tl (Hong Kong), tl (Singapore, Malaysia), tl (Taiwan), pen	
Power supply	24 V DC, 1A	
Operating temperature	+15°C ... +30°C	
Air humidity	max. 80% (non-condensing)	
Housing (W × D × H) mm	210 × 340 × 330	
Wind breaker dimensions (W × D × H) mm	160 × 140 × 205 (inner) 190 × 195 × 225 (outer)	
Scale plate (stainless steel)	Ø 80 mm	
(Net) weight kg	6,2 kg	
Interface	RS-232C	
Contamination degree	2	
Overvoltage category	Category II	
Installation height above sea level	up to 4000 m	
Location site	Solely indoors	

KERN	PLJ 420-3F	PLJ 720-3A	PLJ 1200-3A
Product number / type	TPLJG 420-3-A	TPLJG 720-3-A	TPLJG 1200-3-A
Weighing range (<i>Max</i>)	420 g	720 g	1200 g
Interval (<i>d</i>)	0.001 g	0.001 g	0.001 g
Reproducibility	0.001 g	0.001 g	0.001 g
Linearity	±0.003 g	±0,002 g	±0,003 g
Settling time (standard)	2 s	2 s	2 s
Minimum part weight when counting the number of pieces in laboratory conditions**	5 mg	1 mg	5 mg
Minimum part weight when counting the number of pieces in standard conditions**	50 mg	10 mg	50 mg
Heating time	4 h	4 h	8 h
Adjustment weight	internal		
Number of reference pieces when counting the number of pieces	10, 25, 50, 100, selected freely		
Weight units	ct, g, gn, lb, mo, oz, ozt, tl (Hong Kong), tl (Singapore, Malaysia), tl (Taiwan), pen		
Power supply	230 V/50 Hz (Euro) 9 VDC	230 V/50 Hz (Euro) 24 V DC	
Operating temperature	+15°C/+30°C		
Air humidity	max. 80% (non-condensing)		
Equipment for the under-scales weighing hanger	–	attachment lug, serial equipment	
Housing (W × D × H) mm	210 × 340 × 160		
Wind breaker [mm]	internal: Ø 150, height 60		
	external: Ø 160, height 70		
Scale plate (stainless steel)	Ø 11 cm		
(Net) weight kg	3.5 kg	4.9 kg	4.9 kg
Interface	RS-232C		
Contamination degree	2		
Overvoltage category	Category II		
Installation height above sea level	up to 4000 m		
Location site	Solely indoors		

KERN	PLJ 2000-3A	PLJ 4200-2F	PLJ 6200-2A
Product number / type	TPLJG 2100-3-A	TPLJG 4200-2-A	TPLJG 6200-2-A
Weighing range (<i>Max</i>)	2100 g	4200 g	6200 g
Interval (<i>d</i>)	0.001 g	0.01 g	0.01 g
Reproducibility	0.002 g	0.02 g	0.01 g
Linearity	±0.004 g	±0,04 g	±0,03 g
Settling time (standard)	2 s	2 s	2 s
Minimum part weight when counting the number of pieces in laboratory conditions**	50 mg	50 mg	10 mg
Minimum part weight when counting the number of pieces in standard conditions**	500 mg	500 mg	100 mg
Heating time	8 h	4 h	4 h
Adjustment weight	internal		
Number of reference pieces when counting the number of pieces	10, 25, 50, 100, selected freely		
Weight units	ct, g, gn, lb, mo, oz, ozt, tl (Hong Kong), tl (Singapore, Malaysia), tl (Taiwan), pen		
Power supply	230 V/50 Hz (Euro) 24 V DC	230 V/50 Hz (Euro) 9 VDC	230 V/50 Hz (Euro) 24 V DC
Operating temperature	+15°C ... +30°C		
Air humidity	max. 80% (non-condensing)		
Equipment for the under-scales weighing hanger	attachment lug, serial equipment	–	attachment lug, serial equipment
Housing (W x D x H) mm	210 x 340 x 330	210 x 340 x 95	210 x 340 x 160
Wind breaker mm internal: Ø 150, height 60 external: Ø 160, height 70	yes	no	no
Scale plate (stainless steel)	Ø 11 cm	Ø 16 cm	Ø 16 cm
(Net) weight kg	6.8 kg	3.8 kg	5.4 kg
Interface	RS-232C		
Contamination degree	2		
Overvoltage category	Category II		
Installation height above sea level	up to 4000 m		
Location site	Solely indoors		

KERN	PLJ 720-3AM	PLJ 6200-2AM
Product number / type	TPLJG 720-3M-A	TPLJG 6200-2M-A
Weighing range (<i>Max</i>)	720 g	6200 g
Interval (<i>d</i>)	0.001 g	0.01 g
Reproducibility	0.001 g	0.01 g
Linearity	±0.002 g	±0,02 g
Verification scale interval (<i>e</i>)	10 mg	100 mg
Verification class	II	II
Minimum weight (<i>Min</i>)	20 mg	50 mg
Settling time (standard)	2 s	2 s
Minimum part weight when counting the number of pieces in laboratory conditions**	1 mg	10 mg
Minimum part weight when counting the number of pieces in standard conditions**	10 mg	100 mg
Heating time	4 h	4 h
Adjustment weight	internal	
Number of reference pieces when counting the number of pieces	10, 25, 50, 100, selected freely	
Weight units	ct, g	
Power supply	230V/50Hz AC (Euro), 24V/1A DC	
Operating temperature	+15°C ... +30°C	
Air humidity	max. 80% (non-condensing)	
Housing (W x D x H) mm	210 x 345 x 155	210 x 345 x 160
Wind breaker [mm]	internal: Ø 150, height 60	
	external: Ø 160, height 70	
Scale plate (stainless steel)	Ø 11 cm	Ø 16 cm
(Net) weight kg	4.9 kg	5.4 kg
Interface	RS-232C	
Contamination degree	2	
Overvoltage category	Category II	
Installation height above sea level	up to 4000 m	
Location site	Solely indoors	

KERN	PLS 420-3F	PLS 720-3A	PLS 1200-3A
Product number / type	TPLSG 420-3-A	TPLSG 720-3-A	TPLSG 1200-3-A
Weighing range (<i>Max</i>)	420 g	720 g	1200 g
Interval (<i>d</i>)	0.001 g	0.001 g	0.001 g
Reproducibility	0.001 g	0.001 g	0.001 g
Linearity	±0.004 g	±0,002 g	±0,003 g
Settling time (standard)	3 s	2 s	2 s
Minimum part weight when counting the number of pieces in laboratory conditions**	5 mg	5 mg	5 mg
Minimum part weight when counting the number of pieces in standard conditions**	50 mg	50 mg	50 mg
Heating time	4 h	4 h	8 h
Recommended adjustment weight (class), not delivered	400 g (E2)	600 g (E2)	1 kg (E2)
Number of reference pieces when counting the number of pieces	10, 25, 50, 100, selected freely		
Weight units	ct, g, gn, lb, mo, oz, ozt, tl (Hong Kong), tl (Singapore, Malaysia), tl (Taiwan), pen		
Power supply	230 V/50 Hz (Euro) 9 VDC	230 V/50 Hz (Euro) 24 V DC	
Battery	operating time 30 h charging time 10 h	–	–
Operating temperature	+15°C ... +30°C		
Air humidity	max. 80% (non-condensing)		
Equipment for the under-scales weighing hanger	attachment lug, serial equipment		
Housing (W x D x H) mm	210 x 340 x 160		
Wind breaker mm	internal: Ø 150, height 60		
	external: Ø 160, height 70		
Scale plate (stainless steel)	Ø 11 cm		
(Net) weight kg	2,7 kg	4.5 kg	4.5 kg
Interface	RS-232C		
Contamination degree	2		
Overvoltage category	Category II		
Installation height above sea level	up to 4000 m		
Location site	Solely indoors		

KERN	PLS 4200-2F	PLS 6200-2A
Product number / type	TPLSG 4200-2-A	TPLSG 6200-2-A
Weighing range (<i>Max</i>)	4200 g	6200 g
Interval (<i>d</i>)	0.01 g	0.01 g
Reproducibility	0.01 g	0.01 g
Linearity	±0.04 g	±0,03 g
Settling time (standard)	3 s	2 s
Minimum part weight when counting the number of pieces in laboratory conditions**	50 mg	50 mg
Minimum part weight when counting the number of pieces in standard conditions**	500 mg	500 mg
Heating time	4 h	4 h
Recommended adjustment weight (class), not delivered	4 kg (E2)	5 kg (E2)
Number of reference pieces when counting the number of pieces	10, 25, 50, 100, selected freely	
Weight units	ct, g, gn, lb, mo, oz, ozt, tl (Hong Kong), tl (Singapore, Malaysia), tl (Taiwan), pen	
Power supply	230 V/50 Hz (Euro) 9 V DC	230 V/50 Hz (Euro) 24 V DC
Battery	operating time 30 h charging time 10 h	–
Operating temperature	+15°C ... +30°C	
Air humidity	max. 80% (non-condensing)	
Equipment for the under-scales weighing hanger	attachment lug, serial equipment	
Housing (W × D × H) mm	210 x 345 x 105	
Wind breaker	no	
Scale plate (stainless steel)	Ø 16 cm	
(Net) weight kg	3 kg	4.5 kg
Interface	RS-232C	
Contamination degree	2	
Overvoltage category	Category II	
Installation height above sea level	up to 4000 m	
Location site	Solely indoors	

KERN	PLS 8000-2A	PLS 20000-1F
Product number / type	TPLSG 8200-2-A	TPLSG 20000-1-A
Weighing range (<i>Max</i>)	8200 g	20 kg
Interval (<i>d</i>)	0.01 g	0.1 g
Reproducibility	0.01 g	0.1 g
Linearity	±0.04 g	±0,4 g
Settling time (standard)	4 s	3 s
Minimum part weight when counting the number of pieces in laboratory conditions*	10 mg	500 mg
Minimum part weight when counting the number of pieces in standard conditions**	100 mg	5 g
Heating time	4 h	4 h
Recommended adjustment weight (class), not delivered	5 kg (E2)	20 kg (E2)
Number of reference pieces when counting the number of pieces	10, 25, 50, 100, selected freely	
Weight units	ct, g, gn, lb, mo, oz, ozt, tl (Hong Kong), tl (Singapore, Malaysia), tl (Taiwan), pen	
Power supply	230 V/50 Hz (Euro) 24 V DC	230 V/50 Hz (Euro) 9 V DC
Operating temperature	+15°C ... +30°C	
Air humidity	max. 80% (non-condensing)	
Equipment for the under-scales weighing hanger	attachment lug, serial equipment	-
Housing (W x D x H) mm	210 x 345 x 100	210 x 340 x 100
Wind breaker	no	no
Scale plate (stainless steel)	Ø 16 cm	200 x 175 mm
(Net) weight kg	4.8 kg	3.5 kg
Interface	RS-232C	
Contamination degree	2	
Overvoltage category	Category II	
Installation height above sea level	up to 4000 m	
Location site	Solely indoors	

*** Minimum part weight when counting the number of pieces in laboratory conditions:**

- There are optimum ambient conditions to count pieces with high resolution
- No diversification of the counted pieces' weight

****Minimum part weight when counting the number of pieces in standard conditions:**

- There are unsteady ambient conditions (wind gusts, vibrations)
- There is diversification of the counted pieces' weight

2 Declaration of Conformity

The valid Declaration of Conformity EC/UE is available at:

www.kern-sohn.com/ce

i For verified scales (= the ones subject to the conformity assessment procedure), the Declaration of Conformity is included in the delivery scope.



3 Device overview

3.1 Parts

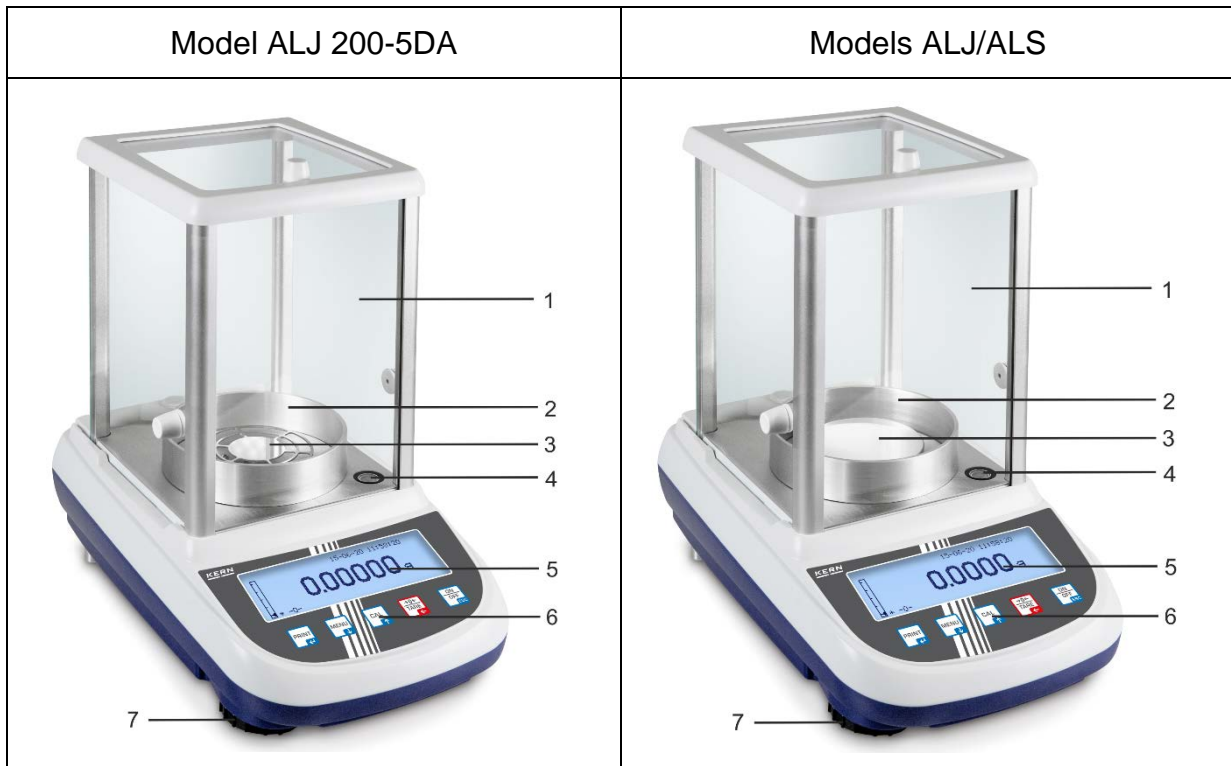
Front:



Item	Name
1	Glass wind breaker
2	Wind breaker ring
3	Scale plate
4	Leveler
5	Display
6	Keyboard
7	Leveling screw foot
8	Ionisator

Model PLJ 2000-3A	Models PLJ/PLS: Scale plate dimensions Ø 110 mm																										
 <p>Diagram of Model PLJ 2000-3A analytical balance. Callouts: 1 points to the glass wind breaker; 2 points to the scale plate; 3 points to the display; 4 points to the keyboard; 5 points to the leveling screw foot; 6 points to the leveler.</p>	 <p>Diagram of Models PLJ/PLS analytical balance. Callouts: 1 points to the leveler; 2 points to the cover of the glass wind breaker; 3 points to the glass wind breaker; 4 points to the scale plate; 5 points to the display; 6 points to the leveling screw foot; 7 points to the keyboard.</p>																										
<table border="1"> <thead> <tr> <th>Item</th> <th>Name</th> </tr> </thead> </table>	Item	Name	<table border="1"> <thead> <tr> <th>Item</th> <th>Name</th> </tr> </thead> </table>	Item	Name																						
Item	Name																										
Item	Name																										
<table border="1"> <tbody> <tr> <td>1</td> <td>Glass wind breaker</td> </tr> <tr> <td>2</td> <td>Scale plate</td> </tr> <tr> <td>3</td> <td>Display</td> </tr> <tr> <td>4</td> <td>Keyboard</td> </tr> <tr> <td>5</td> <td>Leveling screw foot</td> </tr> <tr> <td>6</td> <td>Leveler</td> </tr> </tbody> </table>	1	Glass wind breaker	2	Scale plate	3	Display	4	Keyboard	5	Leveling screw foot	6	Leveler	<table border="1"> <tbody> <tr> <td>1</td> <td>Leveler</td> </tr> <tr> <td>2</td> <td>Cover of the glass wind breaker</td> </tr> <tr> <td>3</td> <td>Glass wind breaker</td> </tr> <tr> <td>4</td> <td>Scale plate</td> </tr> <tr> <td>5</td> <td>Display</td> </tr> <tr> <td>6</td> <td>Leveling screw foot</td> </tr> <tr> <td>7</td> <td>Keyboard</td> </tr> </tbody> </table>	1	Leveler	2	Cover of the glass wind breaker	3	Glass wind breaker	4	Scale plate	5	Display	6	Leveling screw foot	7	Keyboard
1	Glass wind breaker																										
2	Scale plate																										
3	Display																										
4	Keyboard																										
5	Leveling screw foot																										
6	Leveler																										
1	Leveler																										
2	Cover of the glass wind breaker																										
3	Glass wind breaker																										
4	Scale plate																										
5	Display																										
6	Leveling screw foot																										
7	Keyboard																										

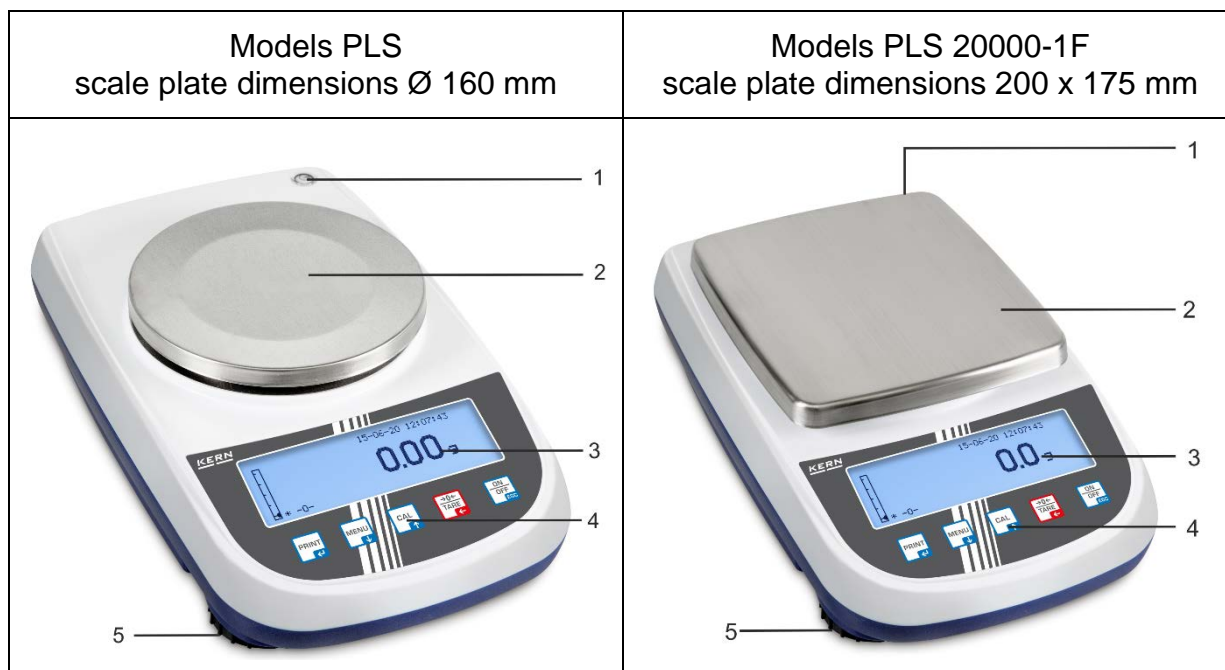

Item	Name
1	Leveler
2	Scale plate
3	Display
4	Keyboard
5	Leveling screw foot

Sample drawing with a ionizing unit installed (KERN ALJ-A03):



Scale back and bottom

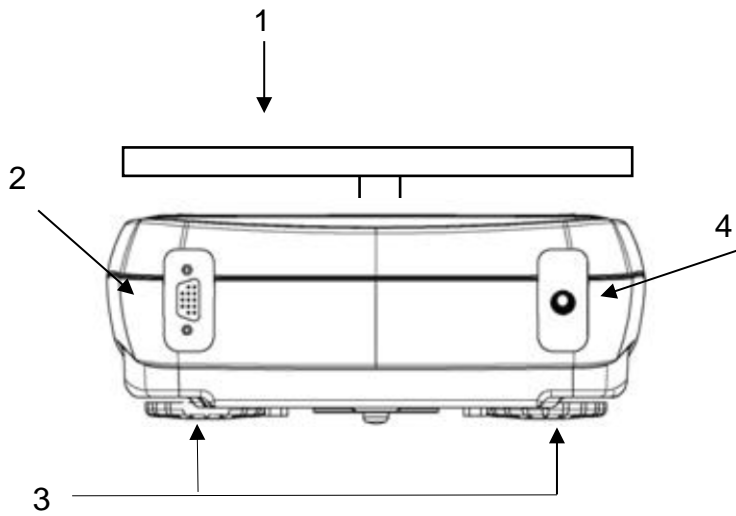

1. Scale plate
2. RS-232C interface
3. Leveling screw foot
4. Power supply socket

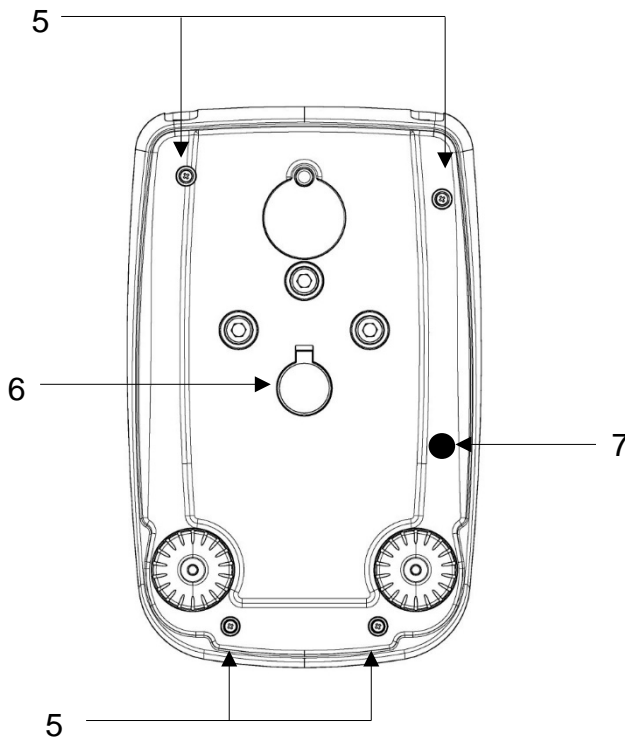





5. Housing screws
(in models with 4 leveling screw feet, first screw out both rear ones)
6. Equipment for the under-scales weighing hanger
7. Transport protection
(solely models with an internal adjustment weight)

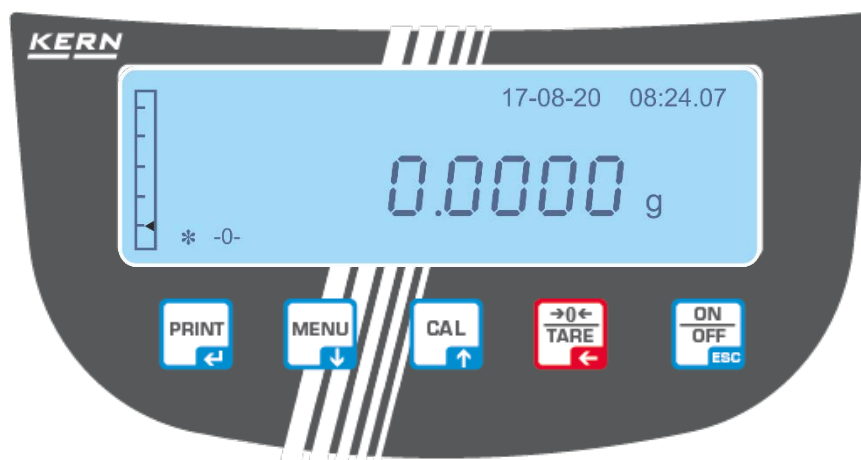



3.2 Operating controls

3.2.1 Keyboard overview



Button	Name	Button pressing	Pressing and holding the button until the sound is heard
	MENU button	<ul style="list-style-type: none"> • Displaying the main / application menu • Menu item selection — scrolling forward 	<ul style="list-style-type: none"> • Displaying the setup menu • Leaving the setup menu
	ON/OFF button	<ul style="list-style-type: none"> • Switching on/off • Leaving the main / application menu, return to the weighing mode 	
	CAL button	<ul style="list-style-type: none"> • Adjustment • Menu item selection — scrolling backward 	
	PRINT button	<ul style="list-style-type: none"> • Weight data transfer via the interface • Setting confirmation/saving 	
	TARE button	<ul style="list-style-type: none"> • Taring • Resetting 	

3.2.2 Navigation buttons / Introducing the numerical value

Button	Name	Button pressing	Pressing and holding the button
	Navigation button ↑	<ul style="list-style-type: none"> Increasing the digit value In the menu: scrolling forward 	Setting a decimal point
	Navigation button ↓	<ul style="list-style-type: none"> Decreasing the digit value In the menu: scrolling backward 	Changing to upper/lowercase
	Navigation button ←	<ul style="list-style-type: none"> Digit positioning Entry deleting 	
	Navigation button ←	Saving	
	ESC	Canceling	

3.3 Display overview

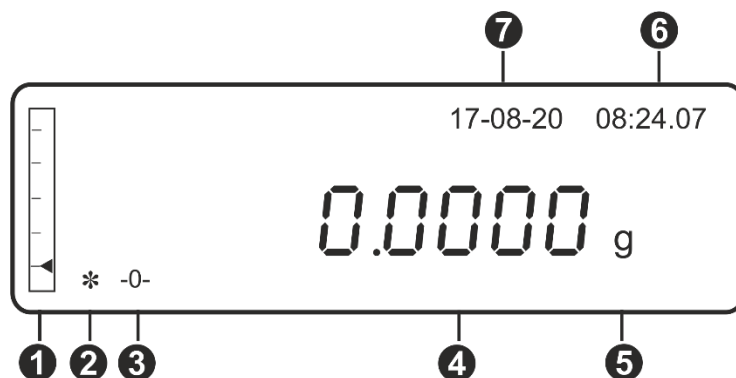

Item	Name
1	Weighing range indicator
2	Stabilization indicator
3	Zero indicator
4	Weighing value
5	Unit
6	Current time
7	Current date

Symbol	Description	see chapter
*	Stabilization indicator	+ chapter 9.3
-0-	Zero indicator	+ chapter 9.3
%	The scale is in the percentage value determination mode	+ chapter 12.5
PC	The scale is in the piece count mode	+ chapter 12.1
H	Upper limit value	+ chapter 12.4
L	Lower limit value	
DS	The scale is in the density determination mode	+ chapter 12.2
▼	The scale is in the data entry mode	
ct, g, gn, lb, mo, oz, ozt, tl (Hong Kong), tl (Singapore, Malaysia), tl (Taiwan), pen	Weight units	+ chapter 11.1
{ }	In the verified scales, the non-verified value is displayed in brackets	

3.4 User interface

Once the application is downloaded, the operator is guided step by step. It is possible to select a language (D, GB, F, IT, ESP, P; see chapter 11.11).

Display example “Piece count”

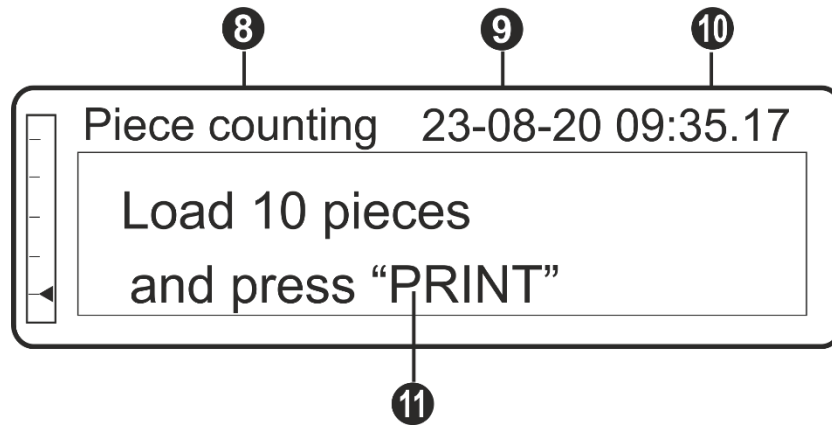

Item	Name
8	Active application
9	Current date
10	Current time
11	Operation carried out

4 Basic instructions

4.1 Intended use

The scale you bought is intended for weighing the weighed material. It should be considered a “non-automatic scale”, e.g. the weighed material should be carefully placed manually on the scale plate center. The weight can be read after it has stabilized.

4.2 Non-intended use

Do not use the scale for dynamic weighing. If the amount of the weighed material is reduced or increased significantly, the scale’s “stabilizing and compensating” mechanism can result in displaying erroneous weighing results! (Example: slow outflow of the liquid from the container placed on the scale.)

Do not subject the plate to long-term load. This may damage the weighing mechanism.

Avoid any scale impact and overload higher than the stipulated maximum load (*Max*), deducting the tare from the existing load. This could damage the scale.

Never operate the scale in explosive atmospheres. The standard version is not explosion-proof.

Never introduce any structural modifications to the scale. This may result in displaying erroneous weighing results, violating the technical safety conditions, and also in scale damage.

The scale should always be operated in line with the provided guidelines. Other operation ranges / areas require a written consent of KERN.

4.3 Warranty

The warranty expires:

- if you fail to follow our guidelines included in the user manual;
- if you fail to use the device in line with the intended use;
- if you introduce any modifications or open the device;
- if the device gets damaged mechanically or damaged by the utilities, liquids and ordinary wear and tear;
- if the device is not set correctly or the electrical system is not as required;
- if the weighing mechanism gets overloaded.

4.4 Testing equipment supervision

Within the quality assurance system, you must check the technical measurement properties of the scale and possibly of the available reference weight regularly. To that aim, the responsible user should define a relevant cycle, as well as the type and scope of such an inspection. The information on the supervision of the testing equipment, i.e. scales, and the required reference weights, can be found on the home page of KERN (www.kern-sohn.com). The reference weights and scales can be calibrated fast and for a low cost in the KERN calibration laboratory (against the national reference) approved by DKD (Deutsche Kalibrierdienst).

5 Basic safety instructions

5.1 Compliance with the instructions included in the user manual



Before you set and start the device, read this user manual thoroughly even if you are familiar with KERN scales.

All language versions contain non-binding translation.
Only the original document in German is binding.

5.2 Personnel training

The device can be operated and maintained solely by trained workers.

6 Transport and storage

6.1 Checking during reception

Immediately after you have received the shipment, please check if it is free from any visible outer damage. The same applies for the unpacked device.

6.2 Packaging / return transport



- ⇒ Please keep all the parts of the original packaging in case you had to send it back to us.
- ⇒ Always use the original packaging for the return transport.
- ⇒ Before you dispatch the device, disconnect any connected cables as well as loose/moving parts.

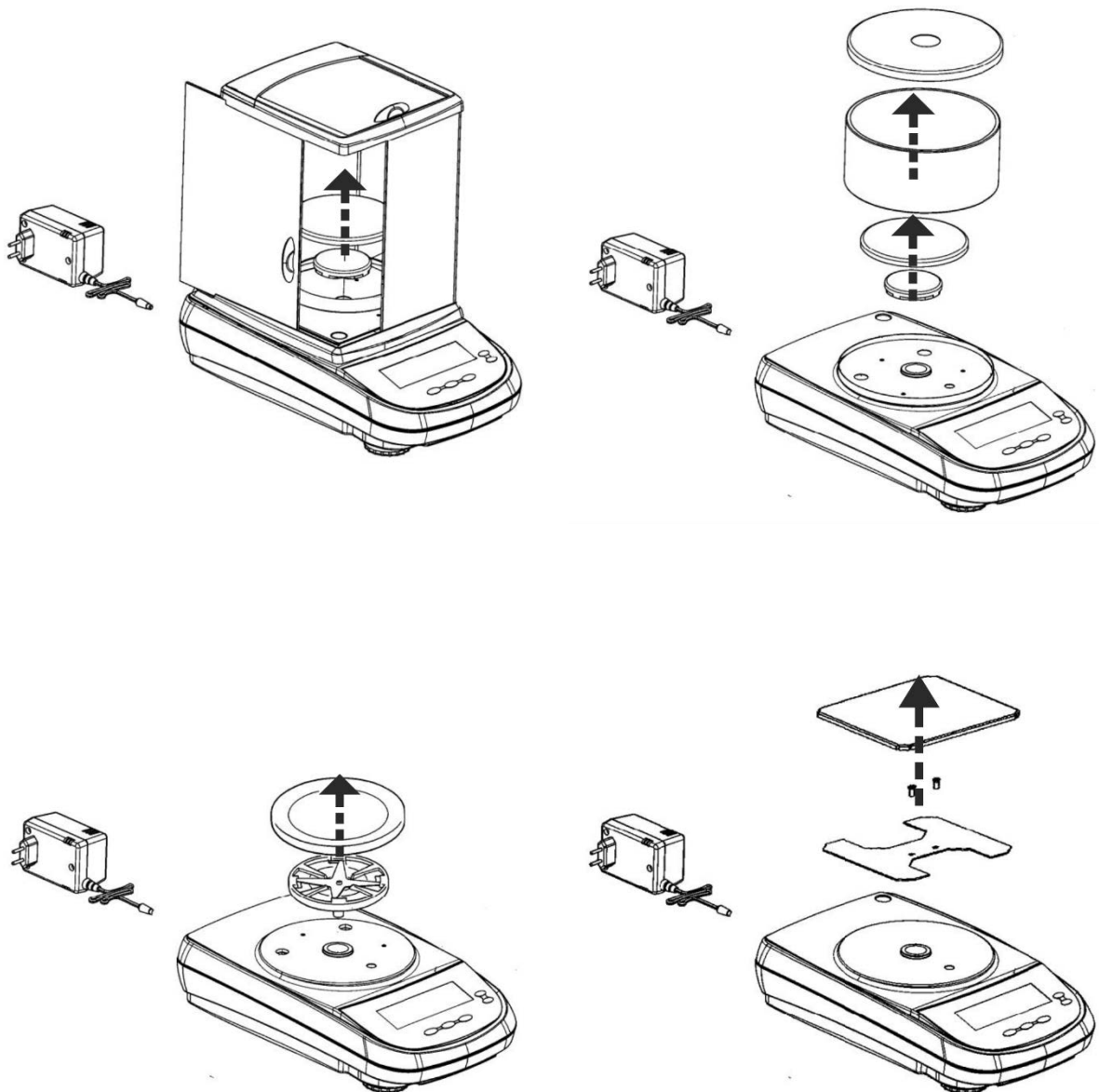

- ⇒ Reinstall any transport locks, if present.
- ⇒ Protect all the parts, e.g. glass wind breaker, scale plates, power supply etc. from slipping and damage.

Sample drawing for analytical scales:

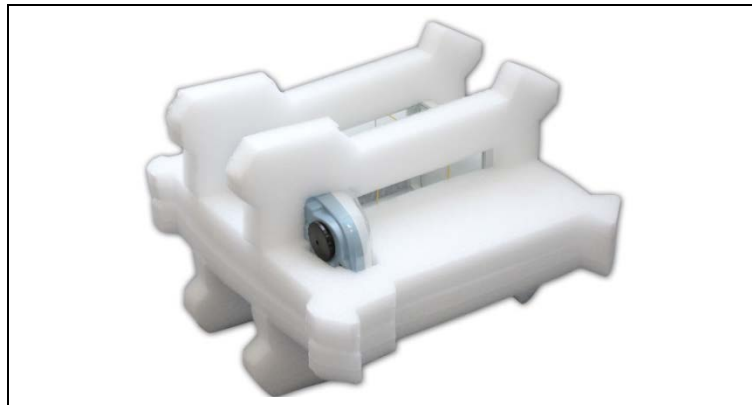
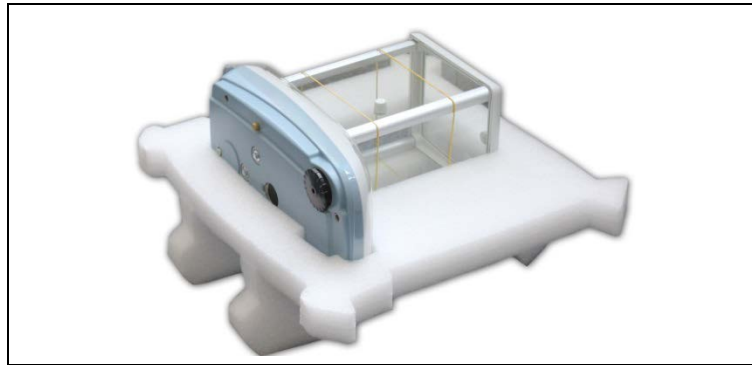

7 Unpacking, positioning and start-up

7.1 Installation place, operation place

The scales are designed to ensure reliable weighing results in standard operating conditions.

The choice of a correct scale location ensures its accurate and fast operation.

This is why you should follow the following rules in the location site:

- Place the scale on stable, flat surface.
- Avoid extreme temperatures and temperature fluctuations, occurring e.g. when you place it at the radiator or in a place exposed to direct sun rays.
- Protect the scale from the direct draft present at open windows and doors.

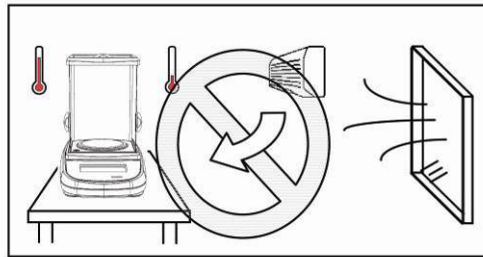

- Avoid impact when weighing.

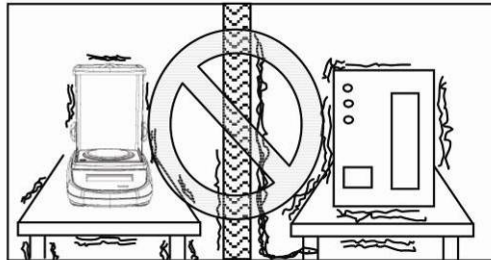

- Protect the scale from high humidity of air, vapors and dust.
- Do not expose it to long-term heavy moisture. Any forbidden condensation of the air moisture on the device may occur when a cold device is placed in a much hotter environment. In such circumstances, leave the device not connected to the mains for 2 hours to adapt to the ambient temperature.
- Avoid static discharge from the weighed material and scale container.

If there are any electromagnetic fields, static discharge and unstable power supply, high readout deviations (erroneous weighing results) may occur. In such circumstances, change the location.

7.2 Unpacking and check

Remove the device and accessories from the packaging, remove the packaging material and place the device in the target location. Check if all components included in the delivery are present and not damaged.

Scope of delivery / standard accessories

- Scale, see chapter 3.1
- Power supply
- Dust cover
- User manual
- Transport protection (solely models with an internal adjustment weight)

7.2.1 Setting

i The correct location is decisive for the accurate weighing results of high-resolution analytical and precision scales (see chapter 7.1).

⇒ Removing transport protection

Models with an internal adjustment weight:

Follow the description in the information leaflet, either

Replace the brass screw [A] with the steel one [B], to the left of the scale bottom (follow the description in the yellow information leaflet).

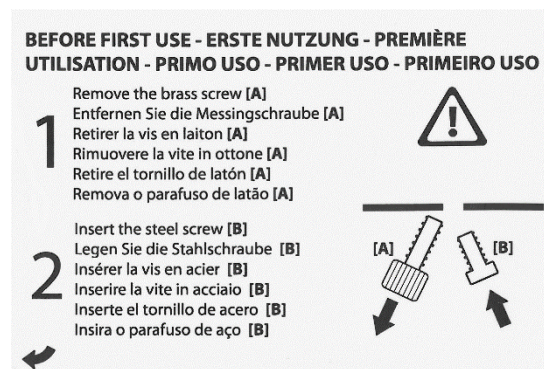

or

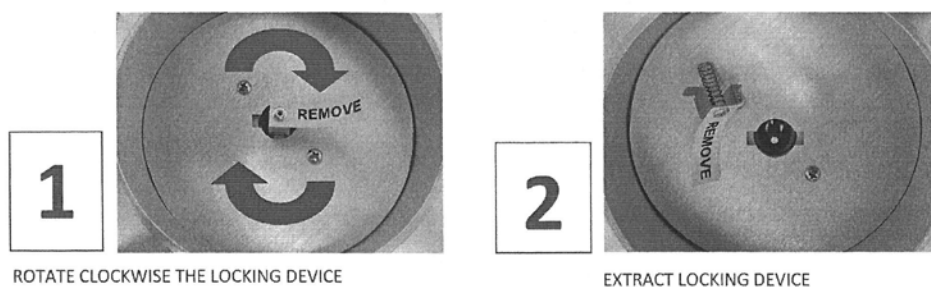

⇒ **Scale installation**

Model ALJ 200-5DA



- ⇒ Place the scale plate with the grate.
- ⇒ Install the wind breaker ring.

Models ALS/ALJ, $d = 0.1$ mg

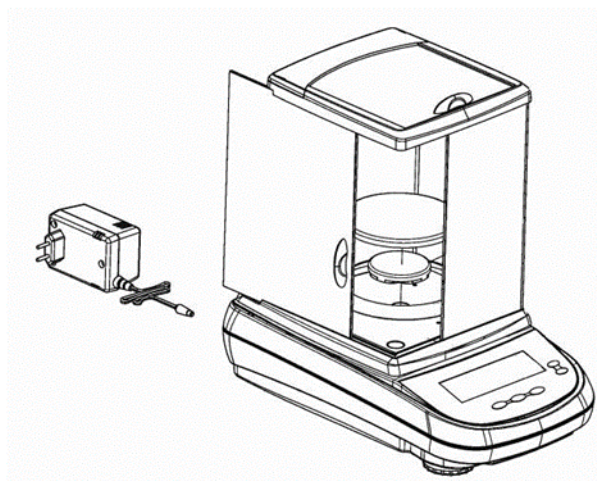

Models PLS/PLJ, $d = 1 \text{ mg}$

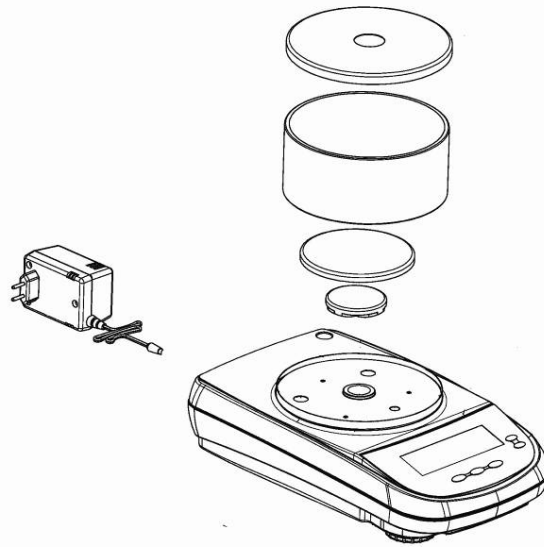

Models PLS/PLJ, $d = 100 \text{ mg}$

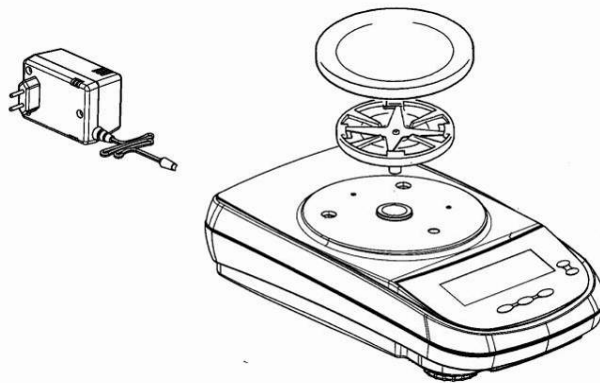

Models PLS/PLJ, $d = 10 \text{ mg}$

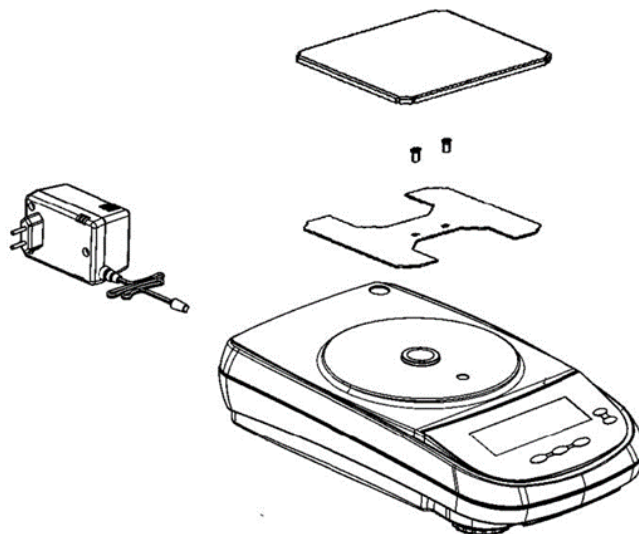

⇒ Leveling

Accurate setting and stable installation are the conditions enabling to obtain repeatable results. Small unevenness or inclination of the base surface can be compensated by leveling the scale.

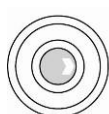
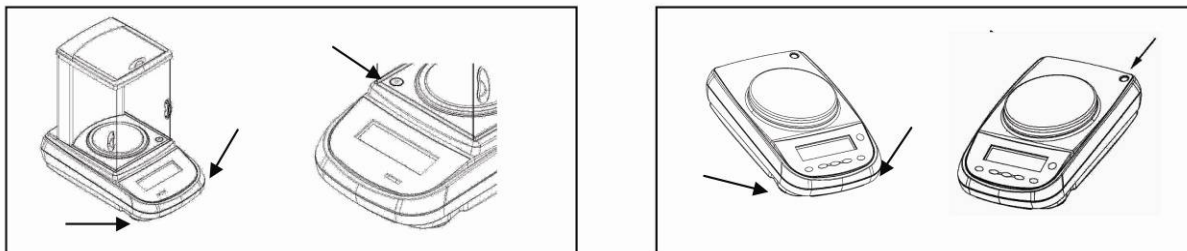

- Level the scale using the leveling feet. The air bubble in the leveler must be present in the marked area.
- Check leveling at regular intervals.

⇒ Connecting power supply

⇒ Connect the scale power supply.

⇒ The scale autotest will be carried out. Next, the scale will switch to the stand-by mode.

The scale connected to the power supply is always on. When you press the **ON/OFF** button, the display will be switched on or off.



7.3 Power supply



Choose the plug appropriate for the operation country and plug it into the power supply.



Check if the scale voltage is set correctly. The scale can be connected to the mains only when the voltage specified on the scale (sticker) and the local voltage are identical.

Always use the original power supply by KERN. Using any other products requires KERN consent.



Important information:

- Before you start the device, check the power cord for damage.
- The power cord must not have any contact with liquids.
- The plug must be always readily available.



To get accurate weighing results using electronic scales, ensure the scales achieves the appropriate operating temperature (see “Heating time”, chapter 1). During the heating time, the scale must be connected to the power source (the socket, rechargeable battery or batteries).

The scale accuracy depends on the local standard gravity.

Always follow the guidelines in the “Adjustment” chapter.

7.4 Operation with battery supply (solely the model PLS 420-3F)

The rechargeable battery is charged using the delivered power supply.

The battery operating time is ca. 30 h, the charging time until fully charged is ca. 10 h.

The AUTO-OFF function can be enabled in the menu, see chapter 11.9. Depending on the menu setting, the scale will be switched to the battery saving mode automatically.

When the scale is battery-operated, the following symbols are displayed:

	The battery is sufficiently charged.
	The battery capacity will soon run down. Connect the power supply as soon as possible to charge the battery.
	The voltage is below the recommended minimum. Connect the power supply to charge the battery.

7.5 Operator language selection

When the device is shipped, German is the preset display language. To set other languages, see chapter 11.11.

7.6 Connecting peripherals

Before you connect or disconnect any extra devices (printer, computer) to/from the data interface, the scale should always be disconnected from the mains.

Use solely accessories and peripherals supplied by KERN with the scale, being perfectly compatible with it.

8 Adjustment

As the standard gravity value is not the same in every spot on Earth, every scale should be adjusted, in line with the weighing rules resulting from the laws of physics, to the standard gravity in the scale location (provided the scale has not already been subject to factory adjustment in its location). Such an adjustment process should be carried out during the first start, following every location change and also in the case of any ambient temperature fluctuations. To ensure achieving accurate measurement data, it is also recommended to carry out regular scale adjustment in the weighing mode.

- ⇒ Ensure stable environmental conditions. The heating time is required for the stabilization (see chapter 1).
- ⇒ Ensure there are no objects on the scale plate.
- ⇒ Adjustment report printout, see chapter 8.6.

8.1 Adjustment mode selection

- ⇒ In the weighing mode press and hold the **MENU** button until the sound signal stops. The configuration menu is displayed.
- ⇒ Using the navigation buttons \updownarrow , select the menu item **<Calibration mode>**.

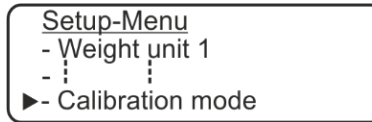

- ⇒ Confirm by pressing the **PRINT** button, the current setting will be displayed.

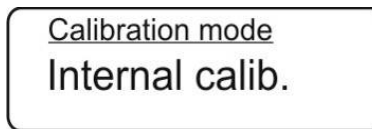

- ⇒ Using the navigation buttons \updownarrow , select the required setting.



Auto. calibration	Automatic adjustment using the internal weight. Factory setting in the models in the verifiable setting.
Internal calib.	Adjustment using the internal weight after the CAL button is pressed. Not available in the models in the verifiable setting.
External calib.	Adjustment using the external weight, not available in the models in the verifiable setting. In models with the internal adjustment weight we do not recommend adjustment using the external weight.
Technical calib.	Changing the weight of the internal calibration weight. Not available in the models in the verifiable setting.

- ⇒ After the “Internal, external or automatic adjustment” option is selected confirm by pressing the **PRINT** button.
After the “Technical adjustment” option is selected, to confirm press and hold the **PRINT** button until the sound signal stops.
The scale will be switched to the menu again.
- ⇒ To leave the menu/return to the weighing mode, press and hold the **MENU** button until the sound signal stops.

8.2 Automatic adjustment using the internal weight

i Factory setting in the models in the verifiable setting (ALJ/PLJ)

The automatic adjustment using the internal weight is started automatically:

- when the scale was disconnected from the mains,
- after the **ON/OFF** button is pressed in the stand-by mode,
- after the temperature is changed by 1.5 degrees Celsius for the non-loaded scale plate / zero indication (this prevents adjustment when a series of measurements is performed)
- after 20 minutes, for the non-loaded scale plate / zero indication (this prevents adjustment when a series of measurements is performed).

The automatic adjustment function is always on. However, it is always possible to carry out manual adjustment (by pressing the **CAL** button) using the internal weight, see chapter 8.3.

Automatic adjustment course:

The **<Cal 25>** symbol informs about the approaching adjustment.

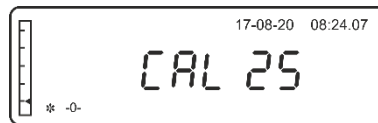

In that time, the user should finish weighing.

The countdown starting from 25 s starts **[CAL 25] → [CAL 0]**.

During that period of 25 s, the adjustment can be stopped and delayed for 5 minutes, pressing the **ON/OFF** button. As a result, the scale will be switched back to the weighing mode, e.g. to complete the ongoing measurement.

8.3 Adjustment using the internal weight after the Model CAL button is pressed (models ALJ/PLJ)

i Preliminary condition: Menu setting “Internal adjustment”, see chapter 8.1.

- ⇒ In the weighing mode, press the **CAL** button, the adjustment will be carried out automatically.

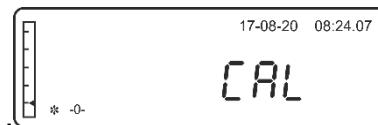
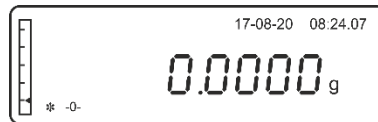

- ⇒ After the successful adjustment, the scale will switch to the weighing mode again automatically.



- ⇒ If an adjustment error occurs (e.g. following an impact), the error message “CAL bUt” will appear on the display. Start the adjustment process again, by pressing the **CAL** button.

8.4 Adjustment using the external weight

- Factory setting in ALS/PLS models
- In ALJ/PLJ models it is available only in the verifiable setting.
- Preliminary condition: Menu setting “External adjustment”, see chapter 8.1.
- The weight of the recommended adjustment weight, see chapter 1 “Technical Specification”.
- Information on reference weights can be found on the Internet at <http://www.kern-sohn.com>.

⇒ Ensure there are no objects on the scale plate. In the weighing mode, press the **CAL** button.



⇒ Wait until the blinking weight value of the required adjustment weight is displayed.



⇒ **During** blinking, place the required adjustment weight carefully in the middle of the scale plate. The blinking symbol will disappear.



⇒ After the successful adjustment, the scale will switch to the weighing mode again automatically.

⇒ Remove the adjustment weight.

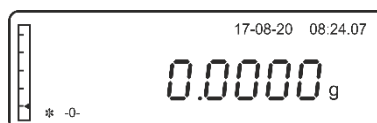

8.5 Changing the weight of the internal calibration weight

! This change can be carried out solely by a specialist holding thorough knowledge of handling scales.

! Information on reference weights can be found on the Internet at <http://www.kern-sohn.com>.

⇒ Display the menu item “Technical adjustment”, see chapter 8.1.

⇒ To confirm, press and hold the **PRINT** button until the sound signal stops.

⇒ Press and hold the **MENU** button until the sound signal stops. The scale will switch to the weighing mode again automatically.

⇒ Ensure there are no objects on the scale plate. Press the **CAL** button.

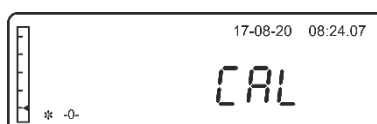
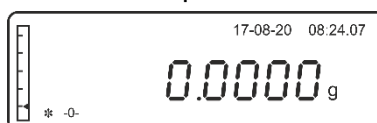

⇒ Wait until the blinking weight value of the adjustment weight is displayed.



⇒ **During** blinking, place the required adjustment weight carefully in the middle of the scale plate. The blinking symbol will disappear.



⇒ Wait until the stabilization indicator is displayed, remove the adjustment weight.

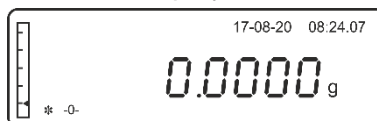

⇒ Press and hold the **PRINT** button until the sound signal stops. The weight of the internal adjustment weight will be changed.

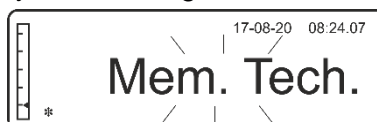

⇒ After the successful change, the scale will switch to the weighing mode again automatically.

8.6 Adjustment report display/print

This function enables to print the report on the most recent adjustment.



The scale and printer communication parameters must be compatible. Communication parameters, see chapter 11.2 and 11.3. Printout conforming to GLP see chapter 12.8.

- ⇒ In the weighing mode press and hold the **MENU** button until the sound signal stops. The configuration menu is displayed.
- ⇒ Using the navigation buttons \uparrow , \downarrow , select the menu item **<Calibration info>**.

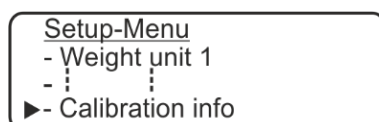

- ⇒ Confirm, pressing the **PRINT** button. The following will be displayed: date, time, adjustment type and deviation when compared to the most recent adjustment.



- ⇒ After the optional printer is connected, the data can be printed by pressing the **PRINT** button.

Sample printout (KERN YKB-01N):

27-08-20 10:41:17	Current date/time
Balance ID: W12000077	
User ID Miller	
Project ID KERN	
Calibration mode 27-08-20 10:11:17 AM	Adjustment date/time
Internal calib.	Adjustment type
Corr.: 0.21 g	Deviation when compared to the most recent adjustment
Signature:	

- ⇒ Press the **ON/OFF** button. The scale will be switched to the menu again. Whenever required, carry out other settings in the menu or press the **ON/OFF** button. The scale will switch to the weighing mode again.

8.7 Verification

General information:

According to the Directive 2014/31/EU, the scales must be verified if they are used in the following way (legally determined scope):

- a) for commercial purposes when the goods' price is determined by weighing them,
- b) to produce medications in pharmacies and also for analyses in medical and pharmaceutical laboratories,
- c) for official purposes,
- d) for manufacturing finished packagings.

In the case of any doubts, contact the local Office of Measures.

Guidelines concerning verification

The scale which is marked verifiable in the technical specification holds a type approval certificate in force in the European Union. If the scale is to be used in the above-mentioned area requiring verification, it must be verified and its verification must be renewed on a regular basis.

Re-verification of the scale is carried out in line with the regulations in force in a given country. E.g. in Germany the scale verification validity period is usually 2 years.

Always follow the regulations in force in the country of use!

Once the verification process is completed, the scale is sealed in the determined position.

Scale verification with no "seal" is invalid.

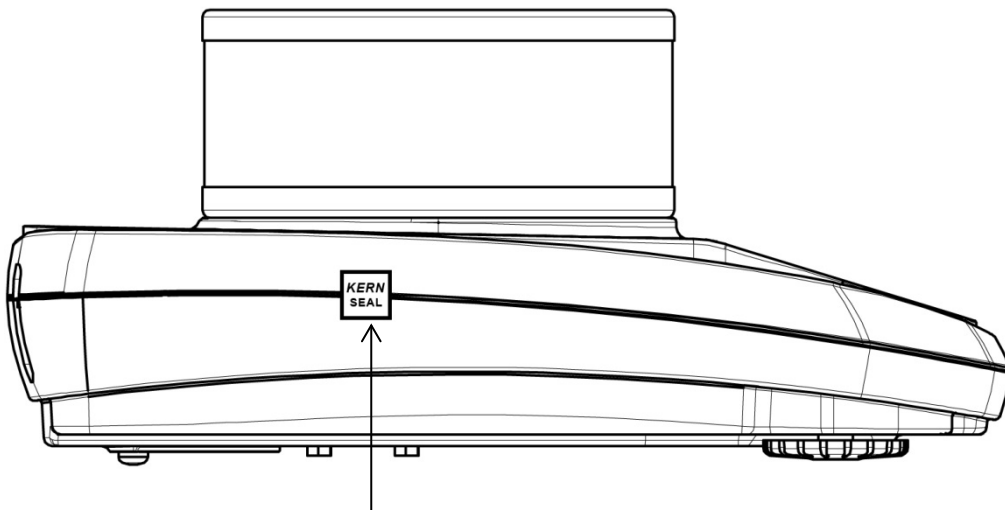

Seal location (PLJ models)

The verifiable scales should be removed from operation if:



- **The scale weighing result is outside the permissible error limit.** This is why the scale should be loaded with the reference weight of a known weight (ca. 1/3 of the *Max* load) regularly and the displayed value should be confirmed with the reference weight.
- **The re-verification deadline is exceeded.**

9 Basic mode

9.1 Switching the scale on and off

Switching on:

- ⇒ In the stand-by mode, press the ON/OFF button. The scale is ready to weigh immediately after the weight symbol is displayed.

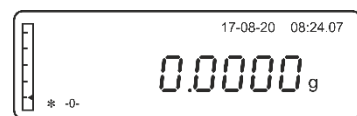
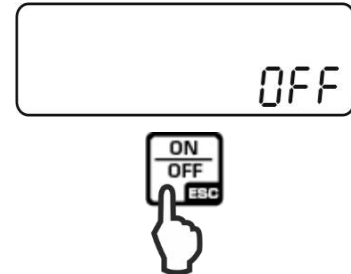

Switching off:

- ⇒ Press the **ON/OFF** button. The scale will be switched to the stand-by mode (energy saving function). The scale is in the stand-by mode.

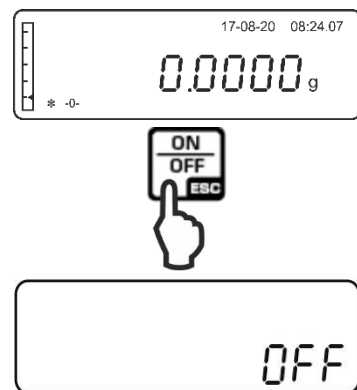

- ⇒ To switch the scale off entirely, disconnect the power supply.

9.2 Resetting

- ⇒ Remove the load from the scale.
- ⇒ Press the **TARE** button. The zero indicator and **[-0-]** symbol will be displayed.

9.3 Ordinary weighing

i To get accurate weighing results, ensure the scale achieves the appropriate operating temperature (see “Heating time”, chapter 1).

- ⇒ Wait until the zero symbol is displayed, reset the scale whenever required, by pressing the **TARE** button.
- ⇒ Place the weighed material.
- ⇒ **Wait until the stabilization indicator is displayed [*].**
- ⇒ Read out the weighing result.

Once the optional printer is connected, the weighing value can be printed.

Sample printouts (KERN YKB-01N):



27-08-20 10:41:17 AM
Gewic.: 50.5773 g

Current date/time

Weighing value

9.4 Weighing range indicator



The weighing range indicator shift [◀] from the bottom upwards reflects the scale load. Its full height is reached for the maximum load. Consequently, the current use of the weighing range is presented in an analogue way.

9.5 Taring

The empty weight of any container used for weighing can be tared, pressing the button which results in displaying the net weight of the weighed material during consecutive weighing processes.

- ⇒ Place the scale container on the scales plate.
- ⇒ Wait until the stabilization indicator is displayed **[*]**, and press the **TARE** button. The “Tare” symbol will be displayed.



- ⇒ Once the stabilization check is successfully completed, the zero symbol will be displayed. The container weight will be saved in the scale memory.

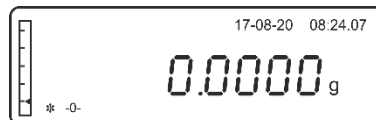

- ⇒ Place the weighed material.
- ⇒ Wait until the stabilization indicator is displayed **[*]**.
- ⇒ Read out the net weight.

Tip:

- After the load is removed from the scale, the tare weight is displayed as a negative value.
- To delete the saved tare value, remove the load from the scale plate and press **TARE** button. The “Tare” symbol will be displayed. Wait until the zero symbol is displayed.
- The taring process can be repeated any number of times. The limit is reached when the complete weighing scope is used.

9.6 Weighing using the under-scales weighing hanger

Weighing using the under-scales weighing hanger enables to weigh any objects which cannot be placed on the scale plate because of their size or shape.

Carry out the following steps:

- Switch the scale off.
- Remove the plug (1) at the scale bottom.
- Suspend the under-scales weighing hanger carefully and accurately.
- Place the scale over an opening.
- Hang the weighed material on the hook and carry out weighing.

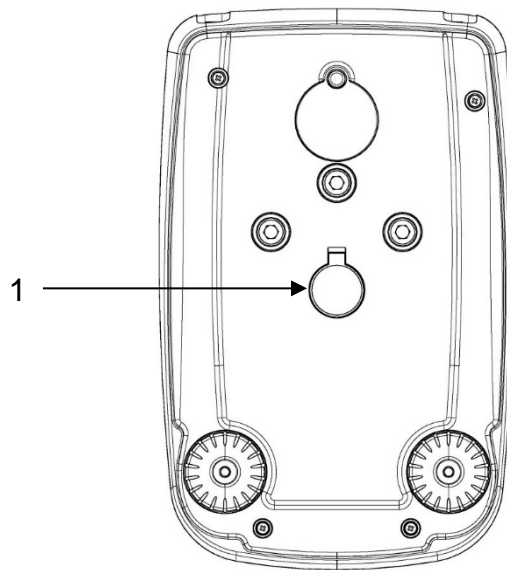

Figure 1: Prepare the scale to use the under-scales weighing hanger



- All hung objects must be stable enough and the weighed material must be fixed securely (the risk of separating).
- Never hang any loads exceeding the specified maximum load (*Max*) (risk of separating).
- No people or animals or items who/which could be injured or damaged can stay under the load.



After you have finished weighing, always close the opening on the scale bottom (dust protection).

11 Setup menu

In the configuration menu, all the basic settings and parameters affecting the total scale operation are entered.

Menu navigation

Entering the menu In the weighing mode press and hold the **MENU** button until the sound signal stops.
The configuration menu is displayed.

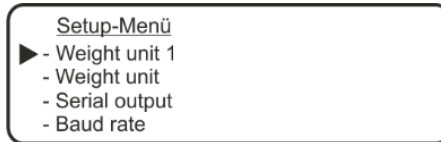

Selecting the menu items

Navigation buttons \updownarrow enable to select subsequent, individual menu items. The active menu item is indicated by the cursor (▶) to the left of the text.



Changing settings

Confirm the menu item selection by pressing the **PRINT** button. The current setting is displayed. The subsequent setting is displayed after pressing the navigation buttons \updownarrow .



Saving settings

Confirm the selection, pressing the **PRINT** button. The scale will be switched to the menu again. Whenever required, select the subsequent menu setting or return to the weighing mode as described below.



Closing the menu / return to the weighing mode

Press the **ON/OFF** button.

or

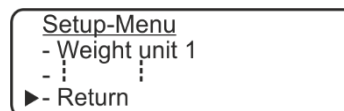

Confirm the selection of the menu item **<Back>** by pressing the **PRINT** button.

Menu overview:

Menu item	Selection	Description
Unit 1 Unit 2 (see chapter 11.1)	g	gram
	ct	karat
	Oz	ounce
	Lb	pound
	Dwt	Pennyweight
	Ozt	Ounce Troy
	GN	Grain
	tl 1	Tael (Hong Kong)
	tl 2	Tael (Singapore)
	tl 3	Tael (Taiwan)
	mo	Momme
RS-232 (see chapter 11.2)	Continuous	Continuous data transfer
	PRINT button	Sending the stable weighing value after the PRINT button is pressed
	Not documented	–
	Not documented	–
	PRINT + DPL	Printout conforming to GLP after the PRINT button is pressed
	Not documented	–
	Not documented	–
Transmission speed (see chapter 11.3)	1,200 bauds	Transmission speed
	2,400 bauds	
	4800 bauds	
	9600 bauds	
Auto zero Automatic zero point correction (see chapter 11.4)	Auto zero OFF	“Auto zero” function is off
	Auto zero 1	Range of the “Auto zero” function $\pm\frac{1}{2}$ digits
	Auto zero 2	Range of the “Auto zero” function ± 3 digits
	Auto zero 3	Range of the “Auto zero” function ± 7 digits
	Auto zero 3E	Range of the “Auto zero” function ± 7 digits in the entire weighing range
Filter (see chapter 11.5)	Filter 1	Dosing setting
	Filter 2	Sensitive and fast — very calm setting item
	Filter 3	Not sensitive but slow — not calm setting item
Stability (see chapter 11.6)	Stability 1	Fast stabilization check / very calm setting item
	Stability 2	Fast and accurate stabilization and check / calm setting item
	Stability 3	Accurate stabilization check / very uncalm setting item

Display contrast (see chapter 11.7)	1-15	Contrast selection
Display backlight (see chapter 11.8)	on	Backlight on
	off	Backlight off
	Auto	Automatic switch-off of the backlight 3 s after the stable weighing value is achieved. The backlight will be switched on again automatically after the weight is changed or the button is pressed.
AUTO OFF (The automatic switch-off function in the stand-by mode) (see chapter 11.9)	Disabled	AUTO-OFF function off
	2 min	Automatic switch off after 2 minutes with no weight change
	5 min	Automatic switch off after 5 minutes with no weight change
	15 min	Automatic switch off after 15 minutes with no weight change
Time and date (see chapter 11.10)		Setting time and date
Language (see chapter 11.11)	Deutsch	User interface language
	Français	
	Español	
	Português	
	English	
	Italiano	
Adjustment mode (see chapter 8.1)	External adjustment	Adjustment using the external weight
	Automatic adjustment	Automatic adjustment using the internal weight
	Internal adjustment	Adjustment using the internal weight after the CAL button is pressed
	Technical adjustment	Changing the weight of the internal calibration weight
Adjustment report (see chapter 8.6)		Printout of the most recent adjustment report
Back		Return to the weighing mode

11.1 Weight units (unit1/unit2)

Weight units which are to be available during operation can be specified in the menu. After different units (unit1 and unit2) are selected, the weighing result can be displayed in two weight units (unit1 and unit2) simultaneously.

To switch between the values in weight “unit1” and “unit2”, use the **PRINT** button.



- For verified scales, not all units are available, see chapter 1 “Technical Specification”.
- When delivered, the factory setting is the “unit1”.

Activating the switchable weight units:

⇒ Using the navigation buttons \updownarrow , select the menu item **<Weight unit 1>**.

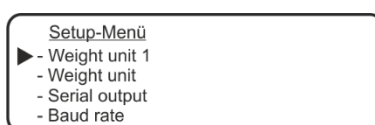

⇒ Confirm by pressing the **PRINT** button, the current setting will be displayed.

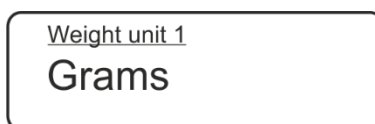

⇒ Using the navigation buttons \updownarrow , select the required setting.



Symbol	Weight unit	Conversion coefficients for 1 g =
g	gram	1.0000
ct	karat	5.0000
Oz	ounce	0.035273962
Lb	pound	0.0022046226
Dwt	Pennyweight	0.643014931
Ozt	Ounce Troy	0.032150747
GN	Grain	15.43235835
tl 1	Tael (Hong Kong)	0.02671725
tl 2	Tael (Singapore)	0.02646063
tl 3	Tael (Taiwan)	0.02666666
mo	Momme	0.2667

⇒ Confirm the selection, pressing the **PRINT** button.
 The scale will be switched to the menu again.

⇒ Using the navigation buttons \updownarrow , select the menu item **<Weight unit 2>** and select the required weight unit as described above.

⇒ Return to the weighing mode, pressing the **ON/OFF** button.

Unit switching:

⇒ In the weighing mode press and hold the **PRINT** button until the sound signal stops, then release the button.

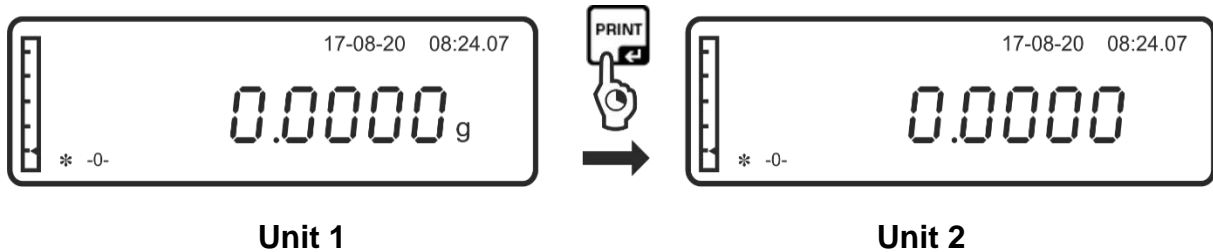

- When switching on from the stand-by mode using the ON/OFF button, the scale will be started with the unit used most recently.
- After the device is disconnected from the mains, the scale will be started with “Unit 1”.

11.2 RS-232

⇒ Using the navigation buttons \updownarrow , select the menu item **<Serial output>**.

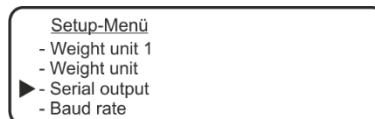

⇒ Confirm by pressing the **PRINT** button, the current setting will be displayed.

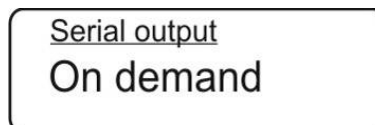

⇒ Using the navigation buttons \updownarrow , select the required setting.



Symbol	Description
<Continuous>	Continuous data transfer
<On demand>	Sending the stable weighing value after the PRINT button is pressed
<Generic printer>	Sending data to the standard printer following the remote control request.
<Printer TLP>	Sending data to the printer supporting the LP-50 protocol.
<On demand – GLP>	The setting used to obtain printouts conforming to GLP, after the PRINT button is pressed
<Generic print.-GLP>	The printout conforming to GLP on a standard printer following the remote setting request
<Printer Tlp – GLP>	The printout conforming to GLP on the printer supporting the LP-50 protocol

- ⇒ Confirm the selection, pressing the **PRINT** button. The scale will be switched to the menu again.
- ⇒ Return to the weighing mode, pressing the **ON/OFF** button.

11.3 Transmission speed

- ⇒ Using the navigation buttons \updownarrow , select the menu item <Baud rate>.

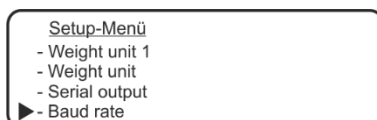

- ⇒ Confirm by pressing the **PRINT** button, the current setting will be displayed.

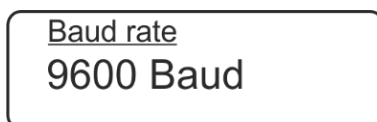

- ⇒ Using the navigation buttons \updownarrow , select the required setting. It is possible to select 1,200, 2,400, 4,800 or 9,600 bauds.
- ⇒ Confirm the selection, pressing the **PRINT** button. The scale will be switched to the menu again.
- ⇒ Return to the weighing mode, pressing the **ON/OFF** button.

11.4 Auto zero

This menu item enables to switch on or off the automatic zero point correction. In the switched on state, the deviation or zero point disturbance is corrected automatically.

Tip:

If the amount of the weighed material is reduced or increased significantly, the scale's "stabilizing and compensating" mechanism can result in displaying erroneous weighing results! (e.g.: slow outflow of the liquid from the container placed on the scale, evaporating processes).

When dosing with small weight fluctuations, it is recommended to switch this function off.

⇒ Using the navigation buttons \updownarrow , select the menu item **<Auto zero>**.

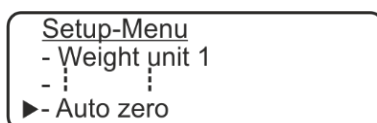

⇒ Confirm by pressing the **PRINT** button, the current setting will be displayed.

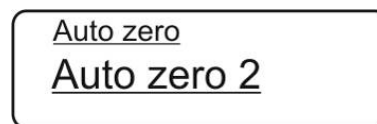

⇒ Using the navigation buttons \updownarrow , select the required setting.



Symbol	Description
Auto zero off	"Auto zero" function is off
Auto zero 1	Range of the "Auto zero" function $\pm 1/2$ digits
Auto zero 2	Range of the "Auto zero" function ± 3 digits
Auto zero 3	Range of the "Auto zero" function ± 7 digits
Auto zero 3E	Range of the "Auto zero" function ± 7 digits in the entire weighing range

⇒ Confirm the selection, pressing the **PRINT** button. The scale will be switched to the menu again.

⇒ Return to the weighing mode, pressing the **ON/OFF** button.

11.5 Filter

This menu item enables to adapt the scale to the specific environment conditions and measurement objectives.

⇒ Using the navigation buttons \updownarrow , select the menu item <Filter>.

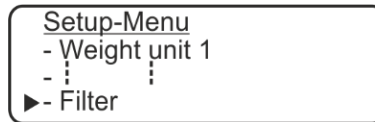

⇒ Confirm by pressing the **PRINT** button, the current setting will be displayed.

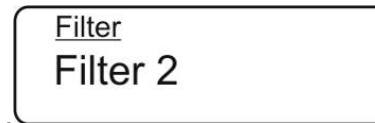

⇒ Using the navigation buttons \updownarrow , select the required setting.



Symbol	Description
Filter 1	Dosing setting
Filter 2	The scale response is sensitive and fast — very calm setting item
Filter 3	The scale response is not sensitive but slow — not calm setting item

⇒ Confirm the selection, pressing the **PRINT** button. The scale will be switched to the menu again.

⇒ Return to the weighing mode, pressing the **ON/OFF** button.

11.6 Stability

⇒ Using the navigation buttons \updownarrow , select the menu item <Stability>.

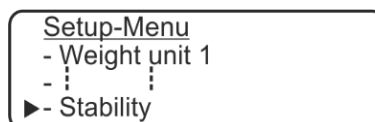

⇒ Confirm by pressing the **PRINT** button, the current setting will be displayed.

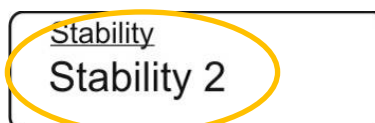

⇒ Using the navigation buttons \updownarrow , select the required setting.

	Symbol	Description
	Stability 1	Fast stabilization check — very calm setting item
	Stability 2	Fast and accurate stabilization and check — calm setting item
	Stability 3	Accurate stabilization check — uncalm setting item

⇒ Confirm the selection, pressing the **PRINT** button. The scale will be switched to the menu again.

⇒ Return to the weighing mode, pressing the **ON/OFF** button.

11.7 Setting the display contrast

When setting the display contrast, you can choose from 15 values.

⇒ Using the navigation buttons \updownarrow , select the menu item **<Contrast adjustment>**.

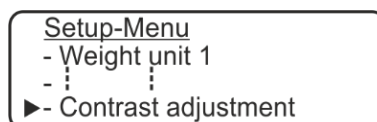

⇒ Confirm by pressing the **PRINT** button, the current setting will be displayed.

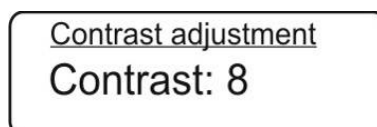

⇒ Using the navigation buttons \updownarrow , select the required setting.

	Symbol	Description
	0	Low contrast
	\updownarrow	\updownarrow
	15	High contrast

⇒ Confirm the selection, pressing the **PRINT** button. The scale will be switched to the menu again.

⇒ Return to the weighing mode, pressing the **ON/OFF** button.

11.8 Display backlight

⇒ Using the navigation buttons \updownarrow , select the menu item <Backlight>.

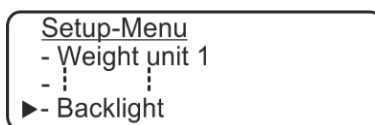

⇒ Confirm by pressing the **PRINT** button, the current setting will be displayed.

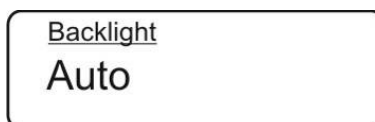

⇒ Using the navigation buttons \updownarrow , select the required setting.



Symbol	Description
Auto	Automatic switch-off of the backlight 3 s after the stable weighing value is achieved. The illumination will be switched on again automatically after the weight is changed or the button is pressed.
On	Backlight on
off	Backlight on

⇒ Confirm the selection, pressing the **PRINT** button. The scale will be switched to the menu again.

⇒ Return to the weighing mode, pressing the **ON/OFF** button.

11.9 Automatic switch-off function

⇒ Using the navigation buttons \updownarrow , select the menu item <Timer off>.

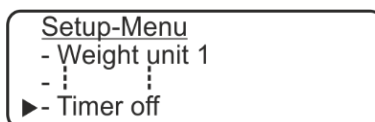

⇒ Confirm by pressing the **PRINT** button, the current setting will be displayed.

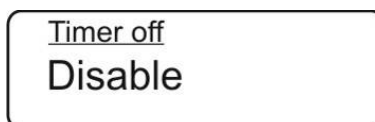

⇒ Using the navigation buttons \updownarrow , select the required setting.



Symbol	Description
Disabled	AUTO-OFF function off
2 minutes	Automatic switch off after 2 minutes with no weight change
5 minutes	Automatic switch off after 5 minutes with no weight change
15 minutes	Automatic switch off after 15 minutes with no weight change

- ⇒ Confirm the selection, pressing the **PRINT** button. The scale will be switched to the menu again.
- ⇒ Return to the weighing mode, pressing the **ON/OFF** button.

11.10 Setting time and date

- ⇒ In the weighing mode press and hold the **MENU** button until the sound signal stops. The configuration menu is displayed.
- ⇒ Using the navigation buttons \updownarrow , select the menu item **<Time and date>**.

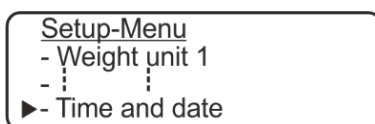

- ⇒ Confirm by pressing the **PRINT** button, the current setting will be displayed.

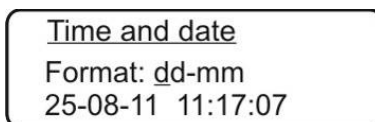

- ⇒ Using the navigation buttons \updownarrow , select the required format.
dd-mm: Day/month
mm-dd: Month/day
- ⇒ Confirm the format selection by pressing the **PRINT** button, set the date and time in the following way.
- ⇒ The active item is displayed by underlining, e.g. 25.
 Using the navigation buttons \updownarrow , set the day and confirm by pressing the **PRINT** button.

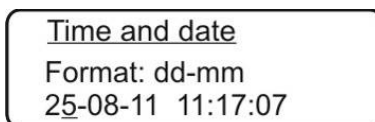

- ⇒ The month will become the active item (it will be underlined). Using the navigation buttons \updownarrow , set the month and confirm by pressing the **PRINT** button.
- ⇒ In the same way set the year, hours, minutes and seconds.
- ⇒ After you finish setting, press and hold the **PRINT** button until the sound signal stops. The scale will be switched to the menu again.

11.11 User interface language

⇒ Using the navigation buttons \updownarrow , select the menu item **<Language>**.

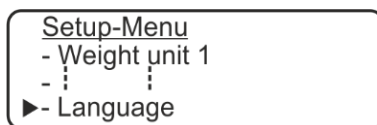

⇒ Confirm by pressing the **PRINT** button, the current setting will be displayed.



⇒ Using the navigation buttons \updownarrow , select the required setting.

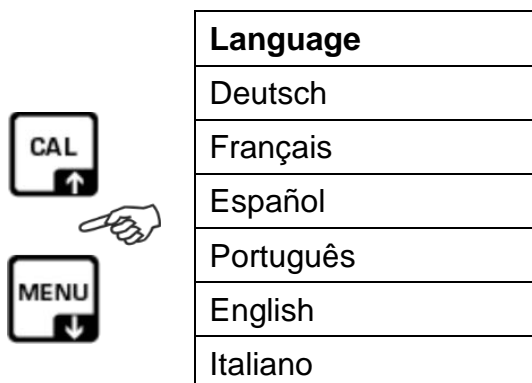

⇒ Confirm the selection, pressing the **PRINT** button. The scale will be switched to the menu again.

⇒ Return to the weighing mode, pressing the **ON/OFF** button.

12 Main menu “Applications”

Menu navigation:

Entering the menu In the weighing mode, press the **MENU** button.
The main menu is displayed.

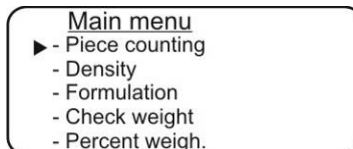

Selecting the menu items

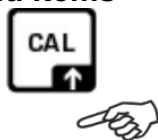

Navigation buttons \updownarrow enable to select subsequent, individual menu items. The active menu item is indicated by the cursor (▶) to the left of the text.

Changing settings

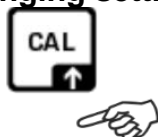

Confirm the menu item selection by pressing the **PRINT** button. The current setting is displayed. The subsequent setting is displayed after pressing the navigation buttons \updownarrow .

Saving settings



Confirm the selection, pressing the **PRINT** button. The scale will be switched to the menu again. Whenever required, select the subsequent menu setting or return to the weighing mode as described below.

Closing the menu / return to the weighing mode



Press the **ON/OFF** button.

or

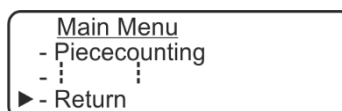

Confirm the selection of the menu item **<Back>**, by pressing the **PRINT** button.

12.1 Counting the number of pieces

The <Piece counting> application enables to count many pieces placed on the scale plate.

Before it is possible to count pieces using the scale, you should determine the average weight of an individual part (unit weight), the so-called reference value. For that purpose, place a specific number of counted parts on it. The scale will determine the total weight which will be divided by the number of pieces, the so-called reference piece number. Next, based on the calculated mean weight of an individual part, the number of pieces will be counted.

The following rule applies:

The higher number of the reference pieces, the higher the accuracy of counting.

12.1.1 Determining the reference value by weighing

⇒ Using the navigation buttons \updownarrow , select the <Piece counting> application and confirm by pressing the **PRINT** button, the current setting of reference pieces will be displayed.

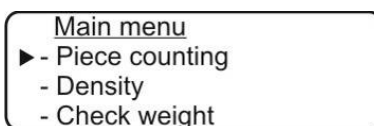

⇒ Using the navigation buttons \updownarrow , select the required setting.

Symbol	Description
10 pieces	Number of reference items 10
25 pieces	Number of reference items 25
50 pieces	Number of reference items 50
100 pieces	Number of reference items 100
Manual	Entering the reference weight value in the numerical form, see chapter 12.1.2



⇒ Whenever required, place the scale container, confirm the preset number of reference items by pressing the **PRINT** button.



⇒ Place the number of the counted parts corresponding to the preset number of reference items.

⇒ Confirm, pressing **PRINT**.



The determined average weight of an individual part will be assumed as the reference weight immediately after the weighing result is stabilized.

The following will be displayed: the currently placed "G" weight, reference weight "AUW" and the number of pieces "St."

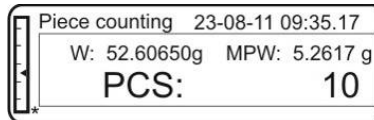

⇒ Remove the reference load. The scale is in the counting mode and counts all parts present on the scales plate.

i If it is impossible to create the reference value due to the weighed material instability or insufficient reference load, the following will be displayed in the course of determining the reference value:

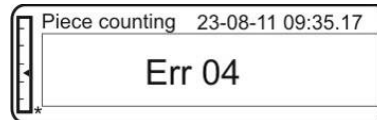

Exceeding the minimum weight of the counted pieces

⇒ Increase the weight of the counted pieces or choose a scale with greater interval.

or

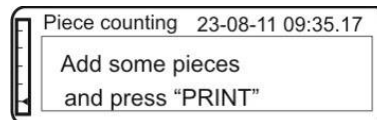

The scale request "Consecutive part..." will be displayed to optimize the reference weight as the placed number of pieces is not sufficient to ensure correct determination of the reference value.

⇒ Place consecutive parts in at least double amount.

Press the **PRINT** button, the reference value is calculated again.

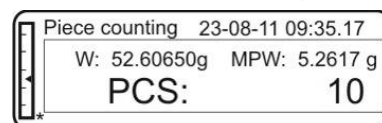
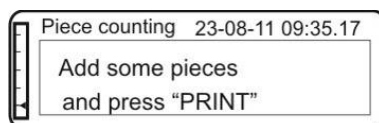

If the placed number of pieces is still too low, add other parts (double amount) and confirm by pressing the **PRINT** button. Repeat the process until the number of pieces is displayed.

The placed number of pieces is sufficient to create the reference value. Remove the reference load. The scale is in the counting mode and counts all parts present on the scale plate.

Determining the number of pieces

- ⇒ After the reference value is determined, place the counted pieces. The following will be displayed: the currently placed “G” weight, reference weight “AUW” and the determined number of pieces “St.”.

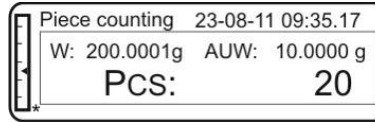

- ⇒ Once the optional printer is connected, the weighing value can be printed.

Sample printout (KERN YKB-01N):



23-08-20 9:35:17	
PCS	20
Weight:	200.0001 g
MPW:	10.000 g

Current date/time

Determined number of pieces

Weight placed

Reference weight

Return to the weighing mode

- ⇒ Press the **ON/OFF** button.



12.1.2 Introducing the reference weight in the numerical value

If the unit weight (reference value) is known, it can be entered directly. As when using this method the scale need not determine the reference value, after the reference unit weight is confirmed the scale will be switched directly to the piece counting mode.

- ⇒ Using the navigation buttons \uparrow , select the **<Piece counting>** application and confirm by pressing the **PRINT** button, the current setting will be displayed.



- ⇒ Using the **MENU** button, choose the “Manual” setting.

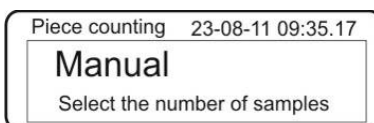

- ⇒ Confirm, pressing **PRINT**.

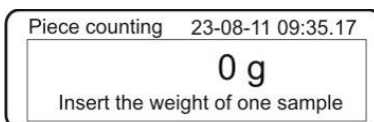

- ⇒ Using the navigation buttons (see chapter 3.2.2), enter the known reference unit weight in grams. To set a decimal point, press the **CAL** button and hold it for some time. Pressing and holding the **TARE** button results in deleting the input.

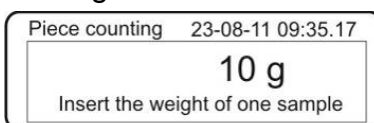

- ⇒ Confirm, pressing **PRINT**.



Starting from then, the scale is in the counting mode and counts all parts present on the scale plate (see chapter 12.1.1 “Counting the number of pieces”).

After the minimum unit weight is exceeded, an error message is displayed. Return to the weighing mode by pressing the **ON/OFF** button and restart the process.

Return to the weighing mode

- ⇒ Press the **ON/OFF** button.

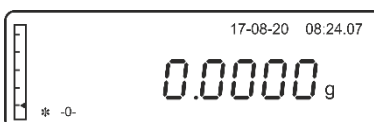

12.1.3 Automatic optimization of the reference value

To improve the counting accuracy, the reference value can be optimized by adding new pieces. For every reference value optimization, the reference weight will be recalculated. As the additional pieces increase the calculation base, the reference value also becomes more accurate.

- ⇒ After the reference weight is set, place the appropriate number of pieces on the scale plate.
- ⇒ Double the number of pieces on the scale plate and wait for the audible signal. The reference weight will be recalculated.
- ⇒ Or repeat the reference value optimization, by adding new pieces (max. 255 pieces) or start the counting process.



The automatic optimization of the reference value is inactive when you enter the reference weight value in a numerical form.

12.2 Determining density using the equipment for the under-scales weighing hanger

Density is the weight [g] to volume [cm³] ratio. The weight is obtained by weighing a sample in the air. The volume is determined based on the hydrostatic lift [g] of the sample immersed in a liquid. Density [g/cm³] of that liquid is known (Archimedes' principle).

Density is determined using the equipment for the under-scales weighing hanger or a kit for the density determination.



The optional density determination kit facilitates the density determination:

analytical scales	KERN YDB-03
precision scales [d] = 0,001 g	KERN ALT-A02
precision scales [d] = 0,01 g	KERN PLT-A01

12.2.1 Determining solid body density using the equipment for the under-scales weighing hanger

Prepare the scale as follows:

- Switch the scale off.
- Turn it upside down carefully.
- Attach the hook for the under-scales weighing (optional).
- Place the scale over an opening.
- Prepare the device for hanging.
- Pour the measurement liquid (e.g. water) in a container (e.g. a beaker) and obtain a constant temperature.

Density determination:

⇒ Using the navigation buttons \updownarrow , select the menu item **<Density>**.

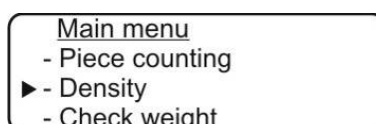

⇒ Confirm by pressing the **PRINT** button, the current setting will be displayed.

⇒ Using the navigation buttons \updownarrow , select the setting **<Solid body>**.

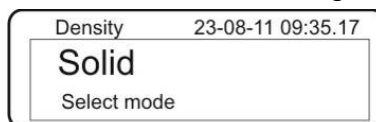

⇒ Confirm, pressing **PRINT**. The present density of the measurement liquid will be displayed (factory setting 1.0000 for distilled water at 20°C).

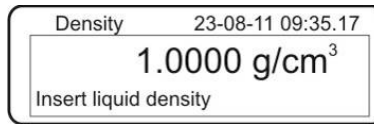

- ⇒ Using the navigation buttons (see chapter 3.2.2), enter the current density of the measurement liquid. For water, see the density table below.
- ⇒ Confirm, pressing the **PRINT** button. The symbol will be displayed to determine the weight “Weigh in the air”.



- ⇒ Using the under-scales weighing hanger, hang the sample on the hook for the under-scales weighing. Wait until the stabilization indicator is displayed, confirm the weight value by pressing the **PRINT** button. The symbol to determine the weight “Sample in water” will be displayed.

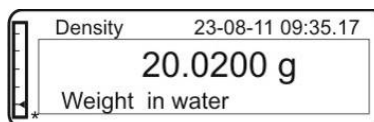

- ⇒ Immerse the sample, avoiding any air bubble formation. Ensure the sample does not touch the beaker.
- ⇒ Wait until the stabilization indicator is displayed, confirm the weight value by pressing the **PRINT** button. Sample density will be displayed.

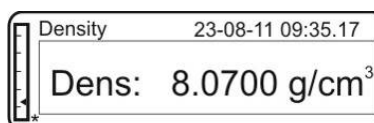
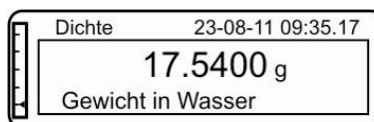

⇒ After the optional printer is connected, the indication value can be printed by pressing the **PRINT** button.

Sample printout (KERN YKB-01N):

23-08-2011:14:57	
d:	8.0700 g/cm ³

If there are any errors when determining the density, “d-----” will be displayed.

i

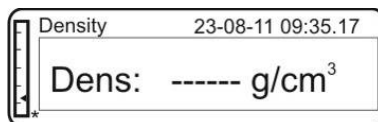

⇒ Return to the density determination mode, pressing the **MENU** button.

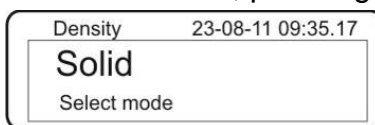

⇒ Return to the weighing mode, pressing the **ON/OFF** button.



Liquid density table

Temperature [°C]	Density ρ [g/cm ³]		
	Water	Ethanol	Methanol
10	0.9997	0.7978	0.8009
11	0.9996	0.7969	0.8000
12	0.9995	0.7961	0.7991
13	0.9994	0.7953	0.7982
14	0.9993	0.7944	0.7972
15	0.9991	0.7935	0.7963
16	0.9990	0.7927	0.7954
17	0.9988	0.7918	0.7945
18	0.9986	0.7909	0.7935
19	0.9984	0.7901	0.7926
20	0.9982	0.7893	0.7917
21	0.9980	0.7884	0.7907
22	0.9978	0.7876	0.7898
23	0.9976	0.7867	0.7880
24	0.9973	0.7859	0.7870
25	0.9971	0.7851	0.7870
26	0.9968	0.7842	0.7861
27	0.9965	0.7833	0.7852
28	0.9963	0.7824	0.7842
29	0.9960	0.7816	0.7833
30	0.9957	0.7808	0.7824
31	0.9954	0.7800	0.7814
32	0.9951	0.7791	0.7805
33	0.9947	0.7783	0.7796
34	0.9944	0.7774	0.7786
35	0.9941	0.7766	0.7777

12.2.2 Liquid density determination

When determining the liquid density, the sinker of a known volume is used (available optionally). The sinker is first weighed in the air and then in the liquid, the density of which is to be determined. The hydrostatic lift stems from the weight difference which is converted into density by the software.

Preparation:

- Pour the analyzed liquid in a container, e.g. a beaker.
- Control the analyzed liquid temperature until it is constant.
- Prepare a sinker of a known density.

Density determination:

⇒ Using the navigation buttons \updownarrow , select the menu item **<Density>**.

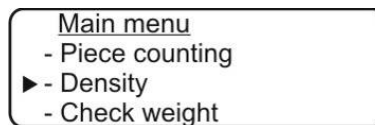

⇒ Confirm by pressing the **PRINT** button, the current setting will be displayed.

⇒ Using the navigation buttons \updownarrow , select the setting "Liquid".



⇒ Confirm, pressing the **PRINT** button. The sinker density will be displayed (factory setting 3.0000 g/cm³).

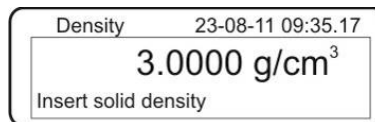

⇒ Using the navigation buttons (see chapter 3.2.2), enter the current density of the sinker.

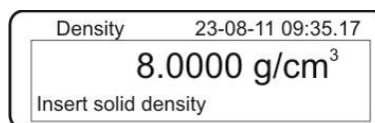

⇒ Confirm, pressing **PRINT**. The symbol to determine the weight "Sinker in the air" will be displayed.



⇒ Using the under-scales weighing hanger, hang the sinker on the hook for the under-scales weighing. Wait until the stabilization indicator is displayed, confirm the weight value by pressing the **PRINT** button. The symbol to determine the weight "Sinker in the analyzed liquid" will be displayed.

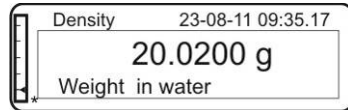

- ⇒ Immerse the sinker in the analyzed liquid, avoiding air bubble formation as much as possible.
Ensure the sinker does not touch the beaker.
- ⇒ Wait until the stabilization indicator is displayed, confirm the weight value by pressing the **PRINT** button. The analyzed liquid density will be displayed.

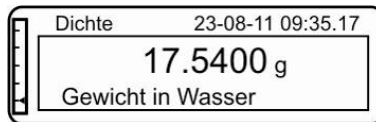

If there are any errors when determining the density, “d-----” will be displayed.

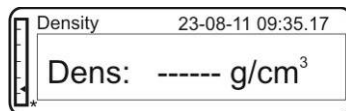

- ⇒ After the optional printer is connected, the indication value can be printed by pressing the **PRINT** button.

Sample printout (KERN YKB-01N):

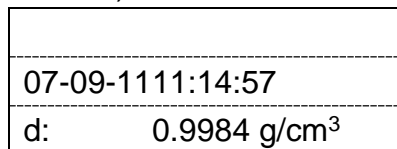

- ⇒ Return to the density determination mode, pressing the **MODE** button.

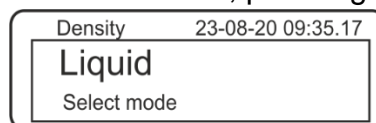

12.3 Formulation

The formulation function enables to weigh the ingredients in a specific ratio. To check, it is possible to print the weight of all ingredients and the total weight (TOT). When the scale is operated, the separate memory is used for the scale container weight and for the formula ingredients.

12.3.1 Free formulation

Selection of the “Manual” formulation mode

⇒ Using the navigation buttons \uparrow , select the menu item **<Formulation>**.

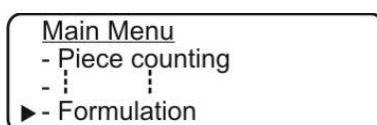

⇒ Confirm, pressing **PRINT**.

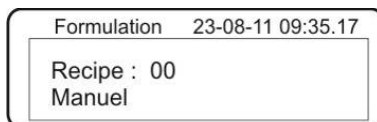

⇒ Confirm, pressing **PRINT**. The symbol will be displayed to enable weighing the first ingredient.

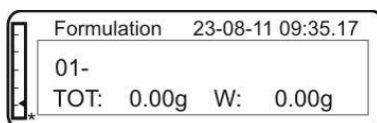

Ingredient weighing

⇒ To use the scale container, tare the scale.
Weigh the first ingredient (e.g. 15 g).

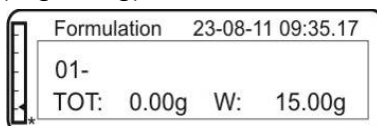

⇒ Confirm, pressing **PRINT**. The weight value is added to the total memory, and printed after the optional printer is connected.

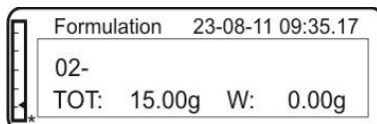

⇒ Weigh the second ingredient (e.g. 5 g).



⇒ Confirm, pressing **PRINT**. The weight value is added to the total memory, and printed after the optional printer is connected.

⇒ Whenever required, weigh other ingredients in the above-mentioned way (max. 99).

Finishing the formulation process

⇒ Press and hold the **PRINT** button until the sound signal stops. The total weight (**TOT:**) of all ingredients will be displayed and printed using the printer.

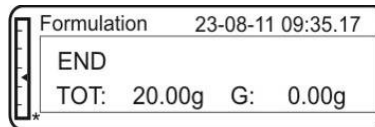

Sample printout (KERN YKB-01N):

07-08-2011:14:57		Date/time
Manual		Formulation mode
1.	15.00 g	Weighed portion of 1st ingredient
2.	5.00 g	Weighed portion of 2nd ingredient
T = 20.00 g		Total weight

⇒ Return to the formulation mode, pressing the **ON/OFF** button and start the next formulation process.

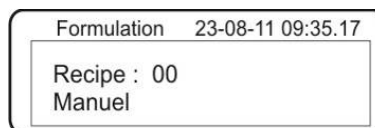

⇒ Return to the weighing mode, pressing the **ON/OFF** button again.

12.3.1 Formulation defining and implementation

The scale has an internal memory for complete formulations with all ingredients and pertinent parameters (e.g. the name of the formulation, name and weight of the ingredient, tolerances). When the formulation is implemented, the operator is guided by the scale step by step when weighing the ingredients.

Formulation defining:

Save max. 99 formulas in the memory, with 20 ingredients each time.

Selection of the formulation mode

⇒ Using the navigation buttons \updownarrow , select the menu item **<Formulation>**.

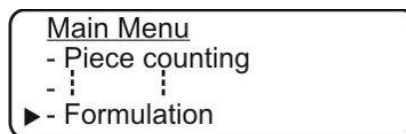

⇒ Confirm, pressing **PRINT**.

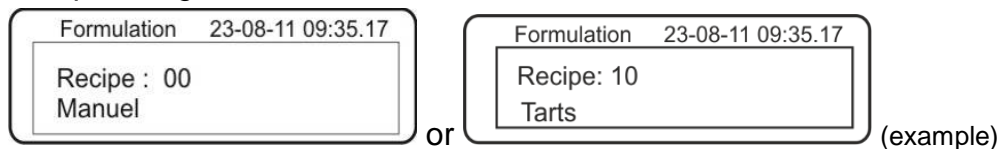

The "Formulation 00" or the name of the most recently introduced formulation will be displayed.

Defining the formulation and ingredients

1. Using the navigation buttons \updownarrow , select the number of the memory location (e.g. 01) for the formulation. Press and hold the **PRINT** button until the sound signal stops. The symbol will be displayed to enable to enter the formulation name.

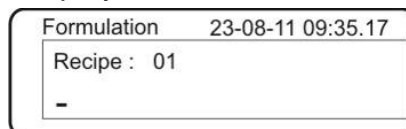

2. Using the navigation buttons (see chapter 3.2.2), enter the formulation name (max. 20 characters).

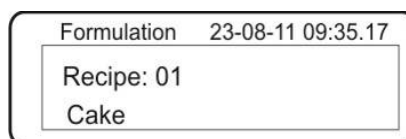

3. Confirm, pressing **PRINT**. The symbol will be displayed to enable to enter the name of the first ingredient.

Formulation	23-08-11 09:35.17
Cake	
01- _	

4. Using the navigation buttons (see chapter 3.2.2), enter the ingredient name (max. 11 characters).

Formulation	23-08-11 09:35.17
Cake	
01- Salt	

5. Confirm, pressing **PRINT**. The symbol will be displayed to enable to enter the quantity.

Formulation	23-08-11 09:35.17
Cake	
01- Salt	0.00g

6. Using the navigation buttons (see chapter 3.2.2), enter the quantity.

Formulation	23-08-11 09:35.17
Cake	
01- Salt	10.00 g

7. Confirm, pressing **PRINT**. The symbol will be displayed to enable to enter the negative tolerance.

Formulation	09-08-12 11:08:20
Cake	
01- Salt	10.000 g
T- = - 0.0 %	

8. Enter the negative tolerance value: Example: -10%

Formulation	09-08-12 11:08:20
Cake	
01- Salt	10.000 g
T- = - 0.0 %	

9. Confirm, pressing the PRINT button. The symbol will be displayed to enable to enter the positive tolerance.

Formulation	09-08-12 11:08:20
Cake	
01- Salt	10.000 g
T- = - 10.0 %	T+ = +0.0 %

10. Enter the positive tolerance value. Example: 5%

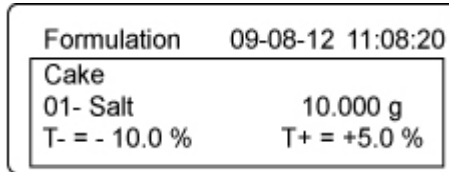

11. Confirm, pressing **PRINT**.

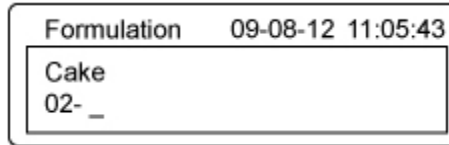

12. To introduce further ingredients (max. 20), repeat steps 3–11 each time.

13. After all the ingredients are introduced, leave the formulation entering mode, by pressing the **ON/OFF** button.

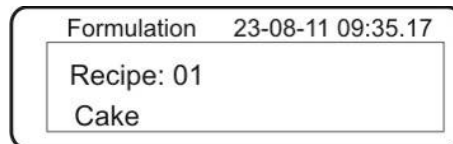

⇒ Return to the weighing mode, pressing the **ON/OFF** button again.



Formulation displaying and implementation:

After the saved formulation is triggered, the scale is immediately ready to weigh the ingredients. The following will be displayed: name and preset value, tolerance and the multiplication factor of every ingredient.

⇒ Using the navigation buttons \updownarrow , select the menu item **<Formulation>**.

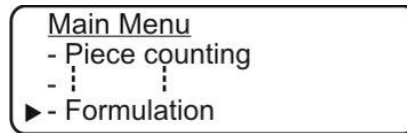

⇒ Confirm, pressing **PRINT**.

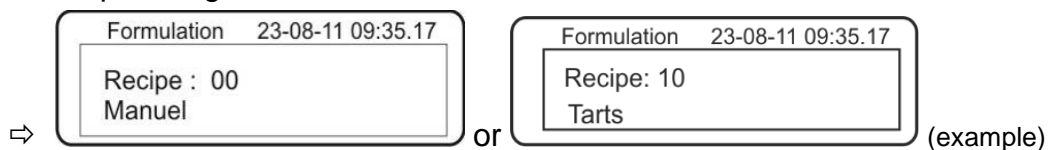

⇒ The “Formulation 00” or the name of the most recently introduced formulation will be displayed.

⇒ Using the navigation buttons \updownarrow , select the required formulation.

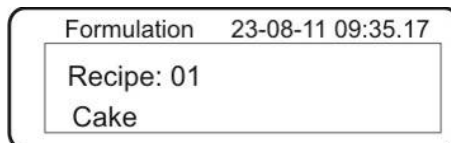

⇒ Confirm, pressing the **PRINT** button. The following will be displayed: the first ingredient, its preset value, as well as the negative and positive tolerance value. Using the navigation buttons \updownarrow , it is possible to display all ingredients with their preset values.

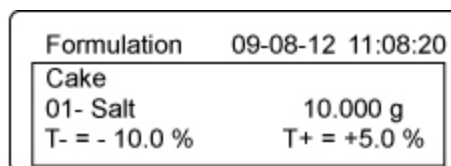

⇒ Select the ingredient and confirm, pressing the **PRINT** button. The symbol will be displayed to enter the multiplication factor.

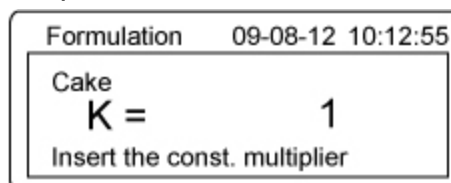

- ⇒ Using the navigation buttons \updownarrow , select the required multiplication factor.
 - 1 = Single formulation amount
 - 2 = Double formulation amount
 - 3 = Triple formulation amount
 - etc.

⇒ Confirm the selected multiplication factor, pressing the **PRINT** button.

Example for the factor 1:

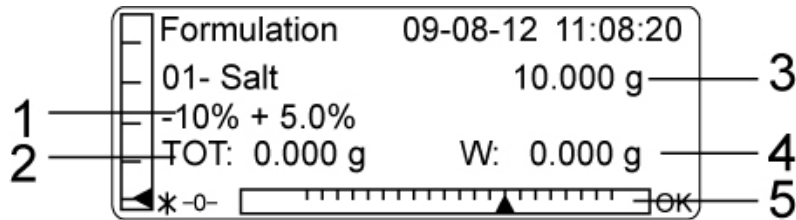

- 1 Tolerance value
- 2 Total weight of all ingredients
- 3 Preset ingredient value
- 4 Total weight of all ingredients
- 5 Tolerance index

Tolerance index overview:

Example: Tolerance from -10.0% to +5.0%

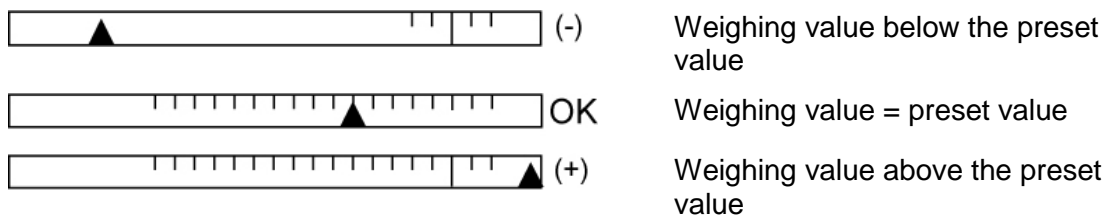

Example: Without entering the tolerance value:

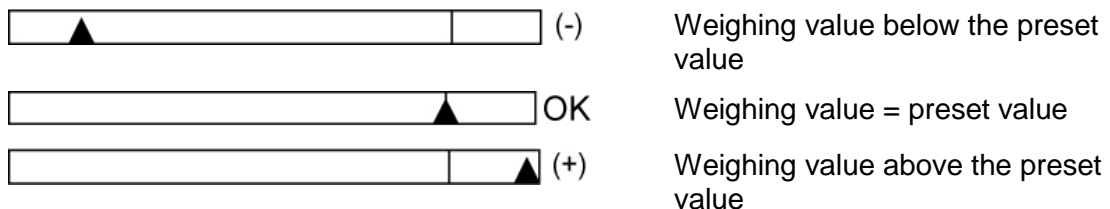

- ⇒ The symbol will be displayed to enable weighing the first ingredient.
- ⇒ To use the scale container, tare the scale. Start weighing. After the preset value is reached, "OK" will be displayed beside the weighing range indicator.

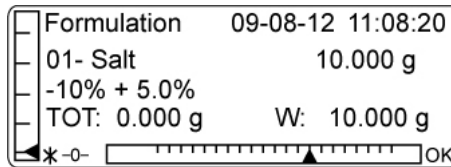

Exceeding the preset value downwards (-) or upwards (+) and pressing the **PRINT** button results in displaying the "Err 10" symbol. Adjust the weighed portion.

- ⇒ After the preset value is reached, press the **PRINT** button. The following will be displayed for a while: "Wait" and then "Tare". Next, the display will change to "G=0" and it will show a symbol enabling to weigh the second ingredient.

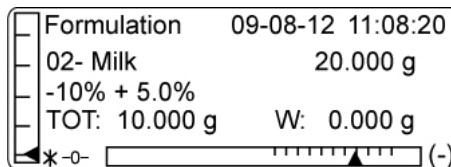
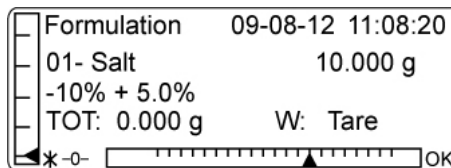
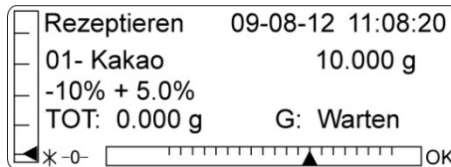

- ⇒ Add the displayed preset value of the second ingredient.

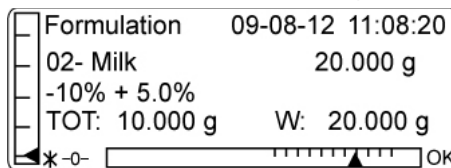

- ⇒ After the last ingredient is weighed and confirmed, the total weight (**TOT:**) of all ingredients will be displayed and printed automatically.

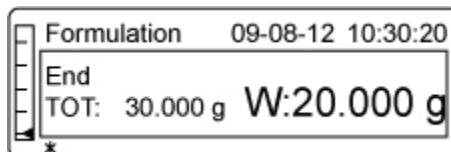

Sample printout (KERN YKB-01N):

07-09-2011:14:57		
Cake		Formulation name
1.	10.00 g	Weighed portion of 1st ingredient
Salt		1st ingredient name
2.	70.00 g	Weighed portion of 2nd ingredient
Milk		2nd ingredient name
3.	0.50 g	Weighed portion of 3rd ingredient
ABC		3rd ingredient name
T =	80.50 g	Total weight

⇒ Return to the formulation mode pressing the **ON/OFF** button and start the next formulation.

Formulation	23-08-11 09:35.17
Recipe: 01	
Cake	

⇒ Return to the weighing mode pressing the **ON/OFF** button again.

Example for the factor 2:

⇒ Trigger the required formulation as described above.

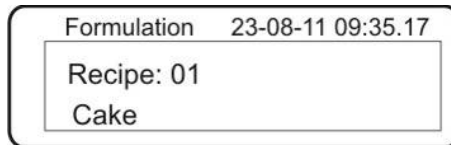

⇒ Confirm by pressing the **PRINT** button. The following will be displayed: the first ingredient, its preset value, as well as the negative and positive tolerance value. Using the navigation buttons $\downarrow\uparrow$, it is possible to display all ingredients with their preset values.

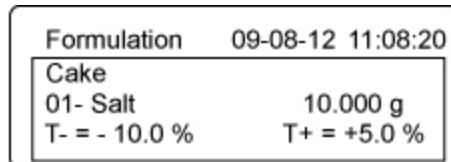

⇒ Select the ingredient and confirm, pressing the **PRINT** button. The symbol will be displayed to enter the multiplication factor.

⇒ Using the navigation buttons $\downarrow\uparrow$, select the multiplication factor "2".

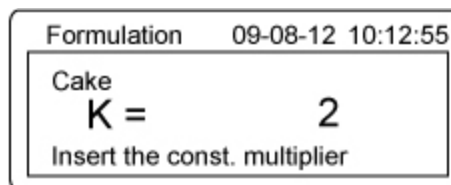

⇒ Confirm the selected multiplication factor, pressing the **PRINT** button.

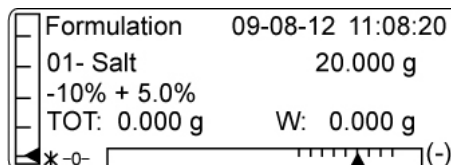

⇒ Now, the double amount will be displayed as the preset value (20.000 g).

⇒ Start weighing. After the preset value is reached, "OK" will be displayed beside the weighing range indicator.

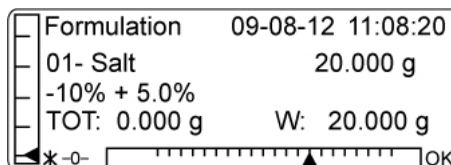

- ⇒ After the preset value is reached, press the **PRINT** button. The following will be displayed for a while: “Wait” and then “Tare”. Next, the display will change to “G=0” and it will show a symbol enabling to weigh the second ingredient.

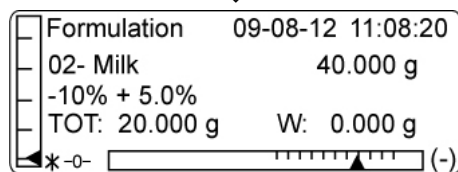
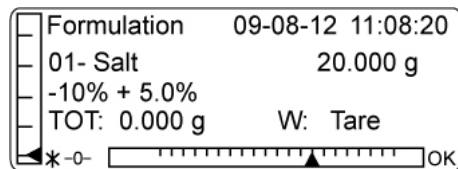
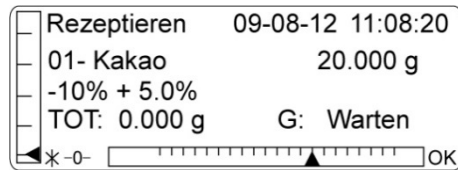

- ⇒ The preset value is “40.000 g” now. Start weighing. After the preset value is reached, “OK” will be displayed beside the weighing range indicator.

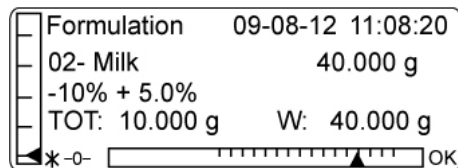

- ⇒ After the last ingredient is weighed and confirmed, the total weight (**TOT:**) of all ingredients will be displayed and printed automatically.

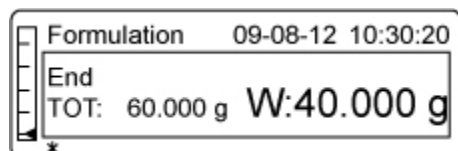

- ⇒ Return to the formulation mode, pressing the **ON/OFF** button and start the next formulation.

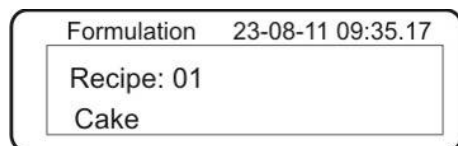

- ⇒ Return to the weighing mode, pressing the **ON/OFF** button again.

12.4 Test weighing

The <Test weighing> application enables to determine the upper and lower limit value and, consequently, to ensure the weight of the weighed material belongs to the range between the determined tolerance limits.

The tolerance symbol (▶) and an audible signal (possible choice) indicate if the weighed material belongs to the range between two tolerance limits.

Result presentation

1. Lower and upper limit value ≥ 0

Tolerance symbol	Audible signal	Assessment
▶ + OK —	no	Weighed material above the preset tolerance
▶ + OK —	yes	Weighed material in the preset tolerance range
+ OK ▶ —	no	Weighed material below the preset tolerance

2. Lower limit value > 0 , upper limit value = 0

Tolerance symbol	Audible signal	Assessment
+ ▶ OK —	yes	Weighed material $>$ the lower limit value
+ OK ▶ —	no	Weighed material \leq the lower limit value

3. Lower limit value = 0, upper limit value > 0

Tolerance symbol	Audible signal	Assessment
▶ + OK —	no	Weighed material $>$ the upper limit value
+ ▶ OK —	yes	Weighed material \leq the upper limit value

Settings

⇒ Using the navigation buttons \uparrow , select the menu item **<Check weight>**.

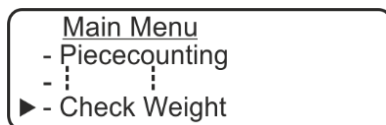

⇒ Confirm, pressing the **PRINT** button. The symbol will be displayed to enter the lower limit value.

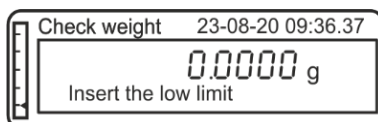

⇒ Using the navigation buttons \uparrow (see chapter 3.2.2), enter the lower limit value, e.g. 9.00 g.

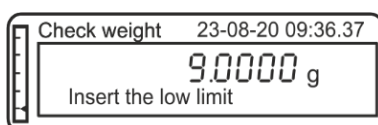

⇒ Confirm, pressing the **PRINT** button. The symbol will be displayed to enter the upper limit value.

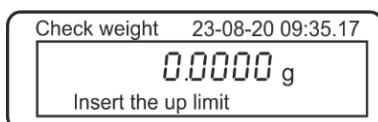

⇒ Using the navigation buttons \uparrow (see chapter 3.2.2), enter the upper limit value, e.g. 11.00 g.

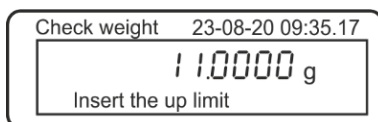

⇒ Confirm, pressing the **PRINT** button. The symbol will be displayed to set the audible signal.

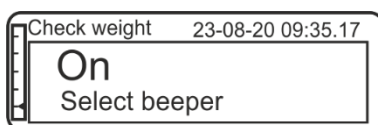

⇒ Using the **MENU** button, select the required setting.

On: Audible signal is on

Off: The audible signal is off

⇒ Confirm, pressing **PRINT**.

From now on, the scale is in the test weighing mode.

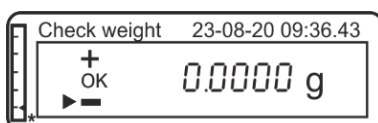

Tolerance check start

- ⇒ To use the scale container, tare the scale.
- ⇒ Place the weighed material. The tolerance check will start.

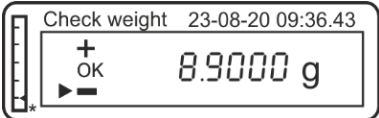
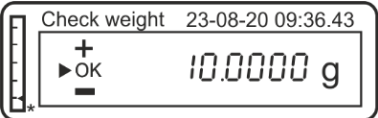
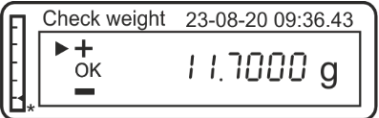
Weighed material below the preset tolerance	Weighed material in the preset tolerance range	Weighed material above the preset tolerance
		

- ⇒ After the optional printer is connected, the indication value can be printed by pressing the **PRINT** button.

Sample printouts (KERN YKB-01N):

Weighed material below the preset tolerance	Weighed material in the preset tolerance range	Weighed material above the preset tolerance
23-08-209:36:43 AM Lim. 1: 9.000 g Lim. 2: 11.000 g Gewic.: 8.900 g TEST : KO! ---	23-08-209:36:43 AM Lim. 1: 9.000 g Lim. 2: 11.000 g Gewic.: 10.000 g TEST : OK!	23-08-209:36:43 AM Lim. 1: 9.000 g Lim. 2: 11.000 g Gewic. : 11.700 g TEST : KO! +++

Return to the weighing mode

- ⇒ Press the **ON/OFF** button.

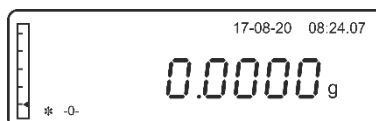

12.5 Determining the percentage value

<Determining the percentage value> application enables to check the percentage sample weight in reference to the reference weight.

12.5.1 Entering the reference weight by weighing

⇒ Using the navigation buttons \uparrow , select the menu item <Percent weigh.>.

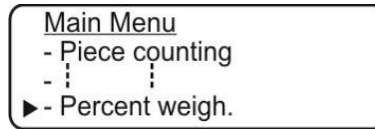

⇒ Confirm by pressing the **PRINT** button, the currently set mode will be displayed.

⇒ Using the navigation buttons \uparrow , select the "Automatic" setting.

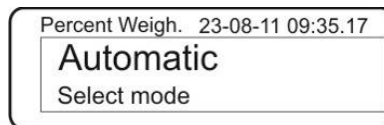

⇒ Place the scale container before you press **PRINT**. The taring process will be started automatically.

⇒ Press the **PRINT** button.

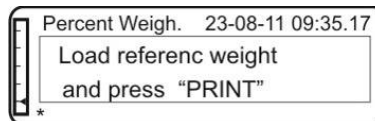

⇒ Place the reference weight (= 100%) and press the **PRINT** button. The determined weight will become the reference value (100%) right after the stable weighing value is reached. From now on, the scale is in the percentage value determination mode.



⇒ Place the weighed material. The result will be displayed.

G% Percentage sample weight

G: Sample weight in grams

BEZ: Reference weight (100%)

Once the optional printer is connected, the displayed value can be printed.

Sample printout (KERN YKB-01N):



07-09-2011:14:57	
Proz.	49.95%
Gewic.:	9.990 g
Bezug:	20.000 g

Percentage sample weight

Sample weight in grams

Reference weight (100%)

12.5.2 Introducing the reference weight in the numerical value

⇒ Using the navigation buttons \uparrow , select the menu item **<Percent weigh.>**.

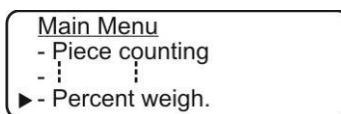

⇒ Confirm by pressing the **PRINT** button, the currently set mode will be displayed.

⇒ Using the navigation buttons \uparrow , select the “Manual” setting.

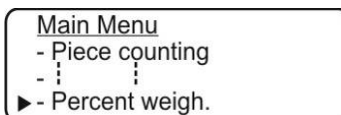

⇒ Confirm, pressing **PRINT**.

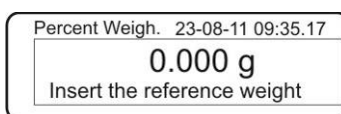

⇒ Using the navigation buttons (see chapter 3.2.2), enter the reference weight (100%) in grams.

⇒ Confirm the entry, pressing the **PRINT** button.

From now on, the scale is in the percentage value determination mode.

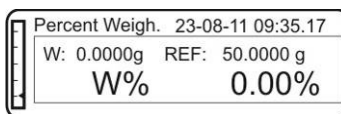

⇒ Place the weighed material. The result will be displayed.

W% Percentage sample weight

W: Sample weight in grams

REF: Reference weight (100%)

Once the optional printer is connected, the displayed value can be printed.

Sample printout (KERN YKB-01N):



07-09-2011:14:57	
Proz.	49.95%
Weight:	9.990 g
Refer. :	20.000 g

Percentage sample weight
Sample weight in grams
Reference weight (100%)

Return to the weighing mode

⇒ Press the **ON/OFF** button.

12.6 Weighing animals

The animal weighing function can be used for uncalm weighing. The mean value of the weighing results will be calculated in a preset timeframe. The less stable the weighed material is, the longer timeframe should be selected.

- ⇒ In the weighing mode, press the **MENU** button. The main menu is displayed.
- ⇒ Using the navigation buttons $\uparrow\downarrow$, select the menu item **<Animal weigh.>**.

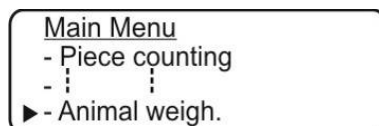

- ⇒ Confirm by pressing the **PRINT** button, the currently set time measurement will be displayed.



- ⇒ Using the navigation buttons $\uparrow\downarrow$, select the required time (5–90s) and confirm by pressing the **PRINT** button.



- ⇒ Place the weighed material and press the **PRINT** button. The countdown of the preset measurement time will be displayed (“Countdown”).

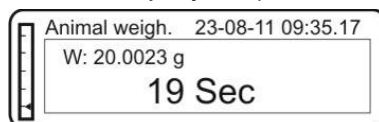

- ⇒ The mean weighing result will be displayed.



Once the optional printer is connected, the displayed value can be printed. Sample printout (KERN YKB-01N):



07-09-2011:14:57	
Time	= 20 Sek
A:	20.0052 g

Measurement time
Weighing result

- ⇒ To carry out consecutive weighing **once**, press the **ON/OFF** button.

Return to the weighing mode:

- ⇒ Press the **ON/OFF** button **twice**.

12.7 Peak value function

This function enables to display the highest loading value (peak value) for one weighing.

The peak value will be displayed until it is deleted.

⇒ Using the navigation buttons \updownarrow , select the menu item **<Maximum load>**.

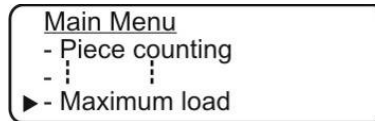

⇒ Confirm, pressing the PRINT button. The taring process will start automatically. The “Tare” symbol will be displayed for a while. From now on, the scale is in the peak value determination mode.



⇒ Load the scale plate. The highest load will be displayed.



⇒ The peak value will be displayed until the **TARE** button is pressed. The scale is ready for other weighing.

Once the optional printer is connected, the displayed value can be printed.
Sample printout (KERN YKB-01N):

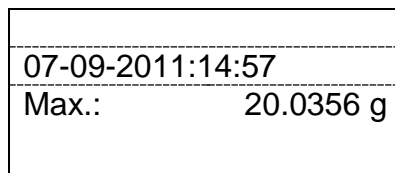

Peak value

Return to the weighing mode:

⇒ Press the **ON/OFF** button.

12.8 GLP function (Good Laboratory Practice)

In the settings of the “GLP” function, the information printed in measurement reports is defined.

⇒ Using the navigation buttons \uparrow , select the menu item **<GLP>**.

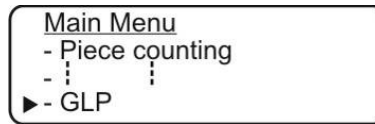

⇒ Confirm, pressing **PRINT**. The symbol will be displayed to enable to enter the scale identification number.

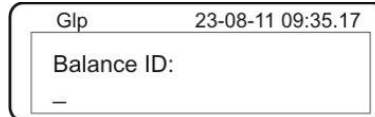

⇒ Using the navigation buttons (see chapter 3.2.2), enter the scale identification number (max. 18 characters).

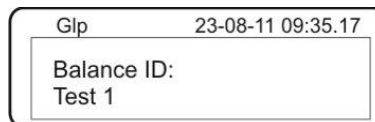

⇒ Confirm by pressing **PRINT**. The symbol will be displayed to enable to enter the user ID.

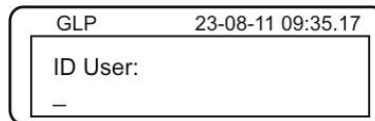

⇒ Using the navigation buttons (see chapter 3.2.2), enter the user ID (max. 18 characters).

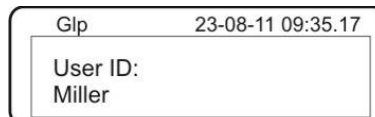

⇒ Confirm, pressing **PRINT**. The symbol will be displayed to enable to enter the project ID.

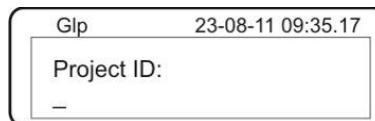

⇒ Using the navigation buttons (see chapter 3.2.2), enter the project ID (max. 18 characters).

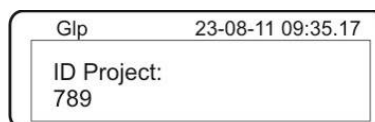

⇒ To save all information, press and hold the **PRINT** button until the sound signal stops. The scale will switch to the weighing mode again automatically.



To obtain printouts conforming to the GLP, enable the menu item “PRINT-GLP button”, see chapter 11.2.

Sample printout (KERN YKB-01N):



07-09-2011:14:57	}	GLP parameters
Balance ID: TEST 1		
User ID Miller		
Project ID: 789		
Weight. 199.991 g	}	Weighing data
Signature:	}	GLP parameters

13 RS-232C interface

A standard scale is equipped with a RS-232C interface used to connect a peripheral device (e.g. a printer or a computer).

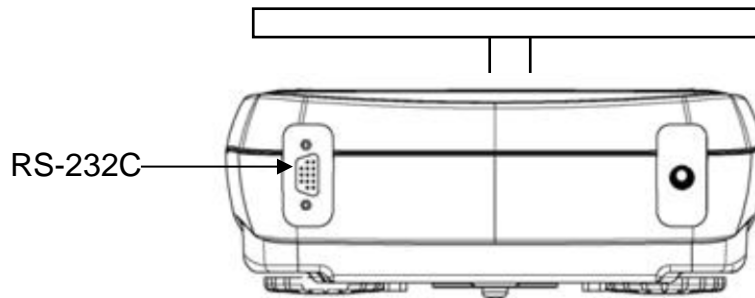

13.1 Technical specification

- 8-bit ASCII code
- 8 data bits, 1 stop bit, no transparency bit
- transmission speed selected in the range of 1,200–9,600 bauds
- Trouble-free operation of the interface is ensured only when the appropriate interface cable by KERN is used (max. 2 m)

To ensure communication between the balance and the printer, the following conditions must be met:

- Connect the scale with the printer interface using the appropriate cable. Trouble-free operation is ensured only when the appropriate interface cable by KERN is used.
- The scale and printer transmission speeds must be compatible, see chapter 11.3.

13.2 Use of the scale plug pins

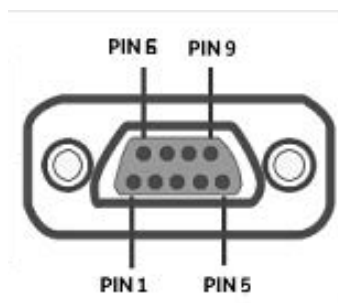

- Pin 1: Power +5V
- Pin 2: Tx Signal
- Pin 3: Rx Signal
- Pin 5: GND

13.3 Interface

- Scale-computer, 25-pin plug

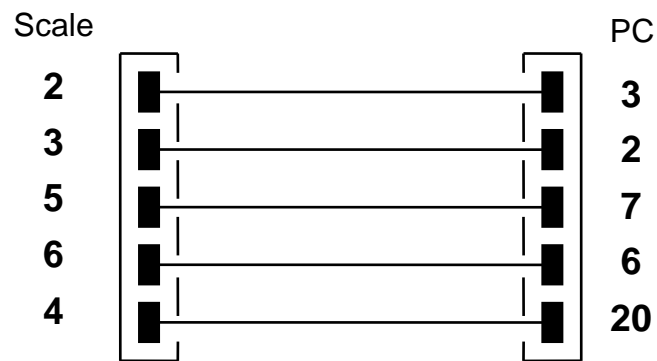

- Scale-computer, 9-pin plug

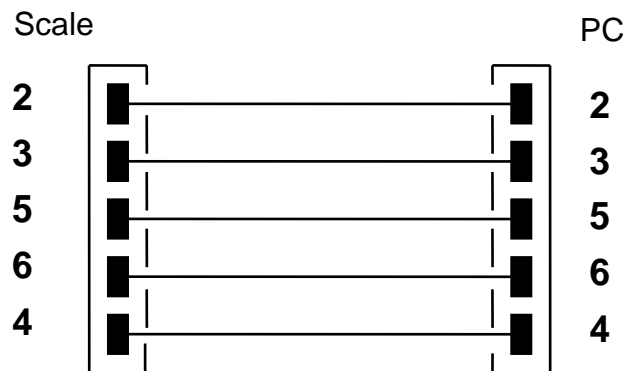

- Scale-printer

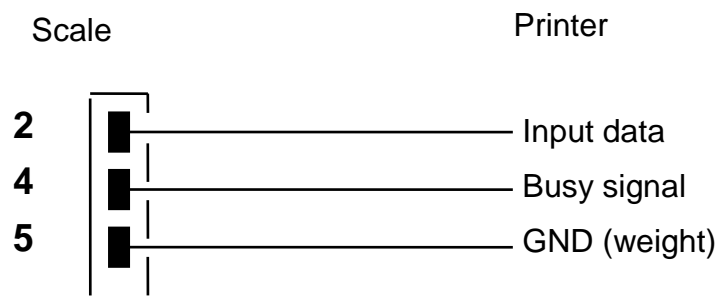

13.3.1 Printer connection

- ⇒ Switch the scale and the printer off.
- ⇒ Connect the scale with the printer interface using the appropriate cable. Trouble-free operation is ensured only when the appropriate interface cable by KERN is used (optional).
- ⇒ Switch the scale and the printer on.



- The scale and printer communication parameters must be compatible, see chapter 11.3.
- Protocol templates are presented in chapters concerning relevant applications.

13.4 Data transmission

A record is composed of the following 14 characters:

1st character	Value / space (weighing value)
2nd–9th characters	Weight or other data
10th–12th characters	Weight unit
13th character	Stabilization indicator
14th character	Carriage return
15th character	Line feed (next line)

13.5 Data transmission formats

For a stable weight, the format will be sent after the **PRINT** button is pressed.

The weighing mode (continuous data transfer and remote control command)

1°	2°	3°	4°	5°	6°	7°	8°	9°	10°	11°	12°	13°	14°	15°r
Symbol	Weight								Weight unit			Stability	CR	LF

Density determination (solely the remote control command)

1°	2°	3°	4°	5°	6°	7°	8°	9°	10°	11°	12°	13°	14°	15°	16°	17°
d	=	Density						Space	Weight unit						CR	LF

Piece count (solely the remote control command)

Number of pieces

1°	2°	3°	4°	5°	6°	7°	8°	9°	10°	11°	12°	13°	14°	15°	16°	
Pcs			:	Space				Number of pieces								

Weight of the placed parts

1°	2°	3°	4°	5°	6°	7°	8°	9°	10°	11°	12°	13°	14°	15°	16°	17°	18°	19°	20°
Weight						:	Space	Weighing value							Space	g	Space	S	

Average part weight

1°	2°	3°	4°	5°	6°	7°	8°	9°	10°	11°	12°	13°	14°	15°	16°	17°	18°
PMU Average part weight		:	Space				Weighing value									Space	g

Percentage value determination (solely the remote control command)

Percentage value

1°	2°	3°	4°	5°	6°	7°	8°	9°	10°	11°	12°	13°	14°	15°	16°	17°	18°
Percent			.	Space				Percent							Space	%	

Weight value

1°	2°	3°	4°	5°	6°	7°	8°	9°	10°	11°	12°	13°	14°	15°	16°	17°	18°
Weight						Space	Weight value							Space	g		

Animal weighing (solely the remote control command)

Time

1°	2°	3°	4°	5°	6°	7°	8°	9°	10°	11°	12°	13°	14°	15°	16°	17°	18°
Time				Space	=	Space			Time value	Seconds				Space			



Mean value

1°	2°	3°	4°	5°	6°	7°	8°	9°	10°	11°	12°	13°	14°	15°	16°	17°	18°
Mean		.	=	Space				Mean weight						Space		g	

13.6 Remote control command

Instruction	Function
"T" = H54	Taring
"C" = H43	Adjustment
"E" = H45	Stable weighing value transmission
"M" = H4D	Menu
"O" = H4F	ON/OFF

14 Error messages

ERR01	Unstable weight value or impossible resetting. Check environmental conditions.
ERR02	Adjustment error, e.g. unstable environmental conditions.
ERR03	Adjustment error, e.g. incorrect adjustment weight.
ERR04	Too low/unstable unit weight.
ERR05	Data transmission impossible as the weight value is unstable. Check environmental conditions.
ERR06	Unstable weight value in the density determination mode. Check environmental conditions.
ERR07	Erroneous data upload (counting the number of pieces, density determination etc.).
ERR08	Internal adjustment error.
“UNLOAD”	Weighing range exceeded. Check the scale plate position.
“CAL But”	Carry out scale adjustment.
	Weighing range exceeded (upwards), the load placed exceeds the scale weighing range. Remove the load from the scale.
	Weighing range exceeded (downwards), e.g. the scale plate not placed.

15 Maintenance, service and disposal



Before you start any works related to the maintenance, cleaning and repair, disconnect the device from the operating voltage.

15.1 Cleaning

Do not use any aggressive cleaning agents (solvents etc.), but clean the device with a cloth and mild soap solution. The liquid must not get inside the device. After the cleaning is finished, wipe the device dry using a soft cloth.

Any loose specimen/powder remains can be removed carefully with a brush or a handheld vacuum cleaner.

Remove any scattered weighed material immediately.

15.2 Maintenance and service

- ⇒ The device can be operated and maintained solely by the technicians trained and authorized by KERN.
- ⇒ Disconnect from the mains before opening.

15.3 Disposal

The packaging and the device should be disposed in accordance with the national or regional law in the location where the device is operated.

16 Help for any minor failures

If there are any programme execution problems, the scale should be switched off and disconnected from the mains for a while. Next, the weighing process should be started anew.

Help:

Problem

Possible cause

- | | |
|--|--|
| The weight indicator is not lit | <ul style="list-style-type: none">• The scale is not on.• Interrupted mains connection (mains cable not connected/damaged).• Mains voltage failure.• Batteries/rechargeable batteries not placed correctly or discharged• No batteries/rechargeable batteries. |
| The weight indication keeps fluctuating. | <ul style="list-style-type: none">• Draft / air movements.• Table/air vibrations.• The scale plate is in contact with foreign bodies.• Electromagnetic fields / static discharge (select another location / if possible, switch off the interfering device). |
| The weighing result is clearly wrong. | <ul style="list-style-type: none">• The scale indication was not reset.• Incorrect adjustment.• There are heavy temperature fluctuations.• The heating time not observed.• Electromagnetic fields / static discharge (select another location / if possible, switch off the interfering device). |

If there are any other error messages displayed, switch the scale off and then on again. If the error message persists, contact the manufacturer.

17 Ionizing unit (factory option for KERN ALJ-A03)

(for model TALJG 210-5-A ioniser as standard)

17.1 General information

The ionizing unit has blades supplied with high voltage. In their immediate vicinity, there are ions generated with a positive and negative charge as a result of corona discharge. The ions are attracted by the weighed material with static charge, neutralizing the interfering static charge. This eliminates also forces falsifying weighing (e.g. the false weighing result, drifting weighing value).

17.2 Basic safety instructions



WARNING



The ionizing unit should be used solely with electronic scales. Do not use it for any other purposes.



Never use the ionizing unit in explosive atmospheres. The standard version is not explosion-proof.



Protect the ionizing unit from high humidity of air / temperature, vapors and dust.

Ensure location free from water/oil.

Do not expose the ionizing unit to long-term heavy moisture. Any forbidden condensation of the air moisture on the ionizing unit may occur when a cold device is placed in a much hotter environment. In such circumstances, leave the ionizing unit not connected to the mains for 2 hours to adapt to the ambient temperature.



When the ionizing unit is on, do not touch the ion source, see the label to the left.



If smoke, burned smell, heavy heating of the ionizing unit occur, or the red LED is lit, switch the ionizing unit off immediately using the main switch and disconnect it from the mains.



If it is discovered water or solid bodies enter the ionizing unit, switch it off immediately using the main switch and disconnect it from the mains.



As the high-voltage technology is used, handle the ion source and outputs carefully.



Do not dismount or modify the ionizing unit.



Protect from any damage resulting from any fall, vibrations or impacts, see the label to the left.



Always use the original power supply. The printed voltage value must be consistent with the local mains voltage.



Injury hazard, the ion source blades are very sharp.



The ionizing unit generates toxic ozone, ensure appropriate ventilation.



Before you start any maintenance and cleaning, disconnect the ionizing unit from the mains.



Disconnect the unused ionizing unit from the mains.



CAUTION



Ensure periodic maintenance and cleaning of the ionizing unit.

Ion source cleaning: after 1,000 hours.

Ion source replacement: After 30,000 hours



Starting a damaged ionizing unit may result in a short circuit, fire or electric shock.



It is prohibited to start it outdoors and in vehicles. It invalidates all warranties.



If there are any electromagnetic fields, high readout deviations (erroneous weighing results) may occur. Discharge the sample at a relevant distance from the scale.



In the standard mode, the green LED [POWER] is lit, if the operation is disturbed, the red LED [ALARM] is lit.

When the red LED is lit, switch the ionizing unit off immediately using the main switch and then on again. If the red LED is still lit, contact the manufacturer.

During ionizing, the blue LED [RUN] is lit.



Operation sounds can be heard during the ionizing process.

17.3 Technical specification

“Sample–ion source” distance	Ca. 5–40 cm
Ozone concentration	0~0.05 ppm (2 cm to the ion source)
Weight	525 g
Dimensions [cm]	110 × 105 × 60
Ambient conditions	0–50°C, air humidity 20–80% (non-condensing)
Power supply input voltage	100–240 VAC; 50/60 Hz
Ionizing unit input voltage	12 VDC, 500 mA
Contamination degree	2
Overvoltage category	Category II
Installation height above sea level	up to 2000 m
Location site	Solely indoors

17.4 Device overview

Keyboard overview

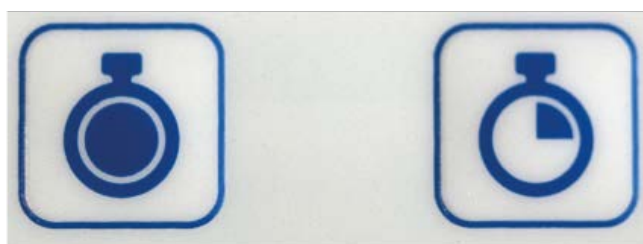

1

2

1 Active ion source (Continuous Mode)
(automatic switch off after 8 h)

2 Active ion source (Time Mode)
(2-minute operation mode)



To switch between the operation modes, press one of the two buttons.

Indication overview



Green LED	Ionizing unit operation	Ionizing unit on
Red LED	Ionizing unit operation	Continuous Mode
Blinking red LED	Ionizing unit operation	Time mode

17.5 Start



Connect the ionizing unit to the power supply solely when the device is on.



- ⇒ Switch the ionizing unit on, pressing the  button.
The ionizing unit is in the “Continuous Mode”, the operating time is 8 hours. The red LED is lit. The ionizing unit will be switched off automatically after 8 hours.



- ⇒ Switch the ionizing unit on, pressing the  button.
The ionizing unit is in the “Time Mode”. The ionizing unit is on for 2 minutes, the red LED blinks. The ionizing unit will be switched off automatically after 2 minutes.
- ⇒ The ionizing unit is on, press any button to switch to any other operating mode.

17.6 Intended use

i The ionizing unit should be used solely with electronic scales!

- Discharging solid bodies or scale containers.

Improved ionization results are obtained when the blower is on, the sample discharging time is reduced.

- Discharging powdery samples. Discharging prevents swirls which are a problem for toxic samples.

If the samples swirl easily, switch the blower off.



- Discharging the weighed material, the glass wind breaker or scale containers.

Place the ionizing unit near the scale.

- Discharging beakers etc.

Shaking a beaker holding a powdery sample results in depositing the powder on the inner wall of the beaker. This is prevented by discharging the beaker.

17.7 Cleaning

	WARNING
	Disconnect the device from the mains before cleaning.
	Do not disassemble the ionizing unit.

Do not use any aggressive cleaning agents (solvents etc.), but clean the device with a cloth and mild soap solution. The liquid must not get inside the device. After cleaning is finished, wipe the device dry using a soft cloth.

Keep the ion source openings clean.