

KERN[®]

KERN & Sohn GmbH

Ziegelei 1

D-72336 Balingen

E-Mail: info@kern-sohn.com

Tel: +49-[0]7433- 9933-0

Fax: +49-[0]7433-9933-149

Internet: www.kern-sohn.com

Operating instructions Compact balance

KERN WTB-N, WTB-NM

Version 2.3

2018-01

GB



WTB-N_WTB-NM-BA-e-1823



KERN WTB-N, WTB-NM

Version 2.3 2018-01

Operating instructions Compact balance

Contents

1	Technical data	4
1.1	Dimensions.....	8
2	Appliance overview	9
2.1	Overview of display	9
2.2	Keyboard overview.....	11
3	Basic Information (General)	12
3.1	Proper use.....	12
3.2	Improper Use	12
3.3	Warranty.....	12
3.4	Monitoring of Test Resources	12
4	Basic Safety Precautions	13
4.1	Pay attention to the instructions in the Operation Manual	13
4.2	Personnel training	13
5	Transport and storage	13
5.1	Testing upon acceptance	13
5.2	Packaging / return transport.....	13
6	Unpacking, Setup and Commissioning.....	14
6.1	Installation Site, Location of Use.....	14
6.2	Unpacking and placing.....	15
6.2.1	Scope of delivery.....	17
6.3	Rechargeable battery operation (optional).....	17
6.3.1	Mains connection during rechargeable battery operation.....	19
6.4	Initial Commissioning	20
6.5	Type of protection IP65.....	20
7	Adjustment	20
7.1	Adjustment	20
7.1.1	Adjustment non verifiable models	21
7.1.2	Adjustment of verifiable models	22
7.2	Verification.....	23
7.2.1	Adjustment switch and seals.....	24
8	Operation	25
8.1	Weighing	25
8.2	Taring	25
8.3	Background illumination	26
8.4	Weighing with tolerance range.....	27
9	The menu	29
9.1	Navigation in the menu	29
9.2	Menu overview (locked in verifiable models)	30
9.3	Set auto-OFF function.....	32
9.4	Multi-Tare function	33
10	Error messages	33
11	Instant help	34
12	Service, maintenance, disposal	35

12.1 Cleaning 35
12.2 Service, maintenance..... 35
12.3 Disposal..... 35
13 Declaration of Conformity 35

1 Technical data

KERN	WTB 1K -4N	WTB 3K -4N	WTB 6K -3N
Weighing range (max)	1.5 kg	3 kg	6 kg
Readability (d)	0.2 g	0.5 g	1 g
Reproducibility	0.2 g	0.5 g	1 g
Linearity	±0.4 g	±1 g	±2 g
Recommended adjustment weight, not added (class)	1500 g (M1)	3 kg (M1)	6 kg (M1)
Stabilization time (typical)	2 sec.		
Units	kg		
Warm-up time	30 min.		
Electric Supply	Input voltage: 110V-230V AC Power supply unit: 12 V, 500 mA		
Rechargeable battery operation	Service life: background illumination ON: 30 h Background illumination off: 50 hours Loading time 12 h		
Auto-Off (rechargeable battery)	15 min., 5 min., 3 min., off		
Display type	LCD with background illumination Character height 2.5 cm		
Operating temperature	-10° C ... + 40° C		
Humidity of air	0 % - 80 % (non-condensing)		
Dimensions of weighing plate (Stainless steel) (mm)	262 x 202		
Casing dimensions	286 x 316 x 126.5		
Weight kg (net)	3.2		
IP protection	IP65		

KERN	WTB 10K -3N	WTB 30K -3N
Weighing range (max)	15 kg	30 kg
Readability (d)	2 g	5 g
Reproducibility	2 g	5 g
Linearity	±4 g	±10 g
Recommended adjustment weight, not added (class)	15 kg (M1)	30 kg (M1)
Stabilization time (typical)	2 sec.	
Units	kg	
Warm-up time	30 min.	
Electric Supply	Input voltage: 110V-230V AC Power supply unit: 12 V, 500 mA	
Rechargeable battery operation	Service life: background illumination ON: 30 h Background illumination off: 50 hours Loading time: 12 h	
Auto-Off (rechargeable battery)	15 min., 5 min., 3 min., off	
Display type	LCD, digit height 25 mm	
Operating temperature	-10° C + 40° C	
Humidity of air	0 % - 80 % (non-condensing)	
Dimensions of weighing plate (Stainless steel) (mm)	262 x 202	
Casing dimensions	286 x 316 x 126.5	
Weight kg (net)	3.2	
IP protection	IP65	

KERN	WTB 1K-4NM	WTB 3K-3NM	WTB 6K-3NM
Weighing range (max)	1.5 kg	3 kg	6 kg
Readability (d)	0.5g	1 g	2 g
Reproducibility	0.5 g	1 g	2 g
Linearity	±0.5 g	±1 g	±2 g
Recommended adjustment weight, not added (class)	1500 g (M3)	3 kg (M3)	6 kg (M3)
Stabilization time (typical)	2 sec.		
Units	kg		
Warm-up time	30 min.		
Electric Supply	Input voltage: 110V-230V AC Power supply unit: 12 V, 500 mA		
Rechargeable battery operation	Service life: background illumination ON: 30 h Background illumination off: 50 hours Loading time 12 h		
Auto-Off (rechargeable battery)	15 min., 5 min., 3 min., off		
Display type	LCD with background illumination Character height 2.5 cm		
Operating temperature	-10° C ... + 40° C		
Humidity of air	0 % - 80 % (non-condensing)		
Dimensions of weighing plate (Stainless steel) (mm)	262 x 202		
Casing dimensions	286 x 316 x 126.5		
Weight kg (net)	3.2		
IP protection	IP65		

KERN	WTB 10K-3NM	WTB 30K-2NM
Weighing range (max)	15 kg	30 kg
Readability (d)	5 g	10 g
Reproducibility	5 g	10 g
Linearity	±5 g	±10 g
Recommended adjustment weight, not added (class)	15 kg (M3)	30 kg (M3)
Stabilization time (typical)	2 sec.	
Units	kg	
Warm-up time	30 min.	
Electric Supply	Input voltage: 110V-230V AC Power supply unit: 12 V, 500 mA	
Rechargeable battery operation	Service life: background illumination ON: 30 h Background illumination off: 50 hours Loading time: 12 h	
Auto-Off (rechargeable battery)	15 min., 5 min., 3 min., off	
Display type	LCD, digit height 25 mm	
Operating temperature	-10° C + 40° C	
Humidity of air	0 % - 80 % (non-condensing)	
Dimensions of weighing plate (Stainless steel) (mm)	262 x 202	
Casing dimensions	286 x 316 x 126.5	
Weight kg (net)	3.2	
IP protection	IP65	

1.1 Dimensions

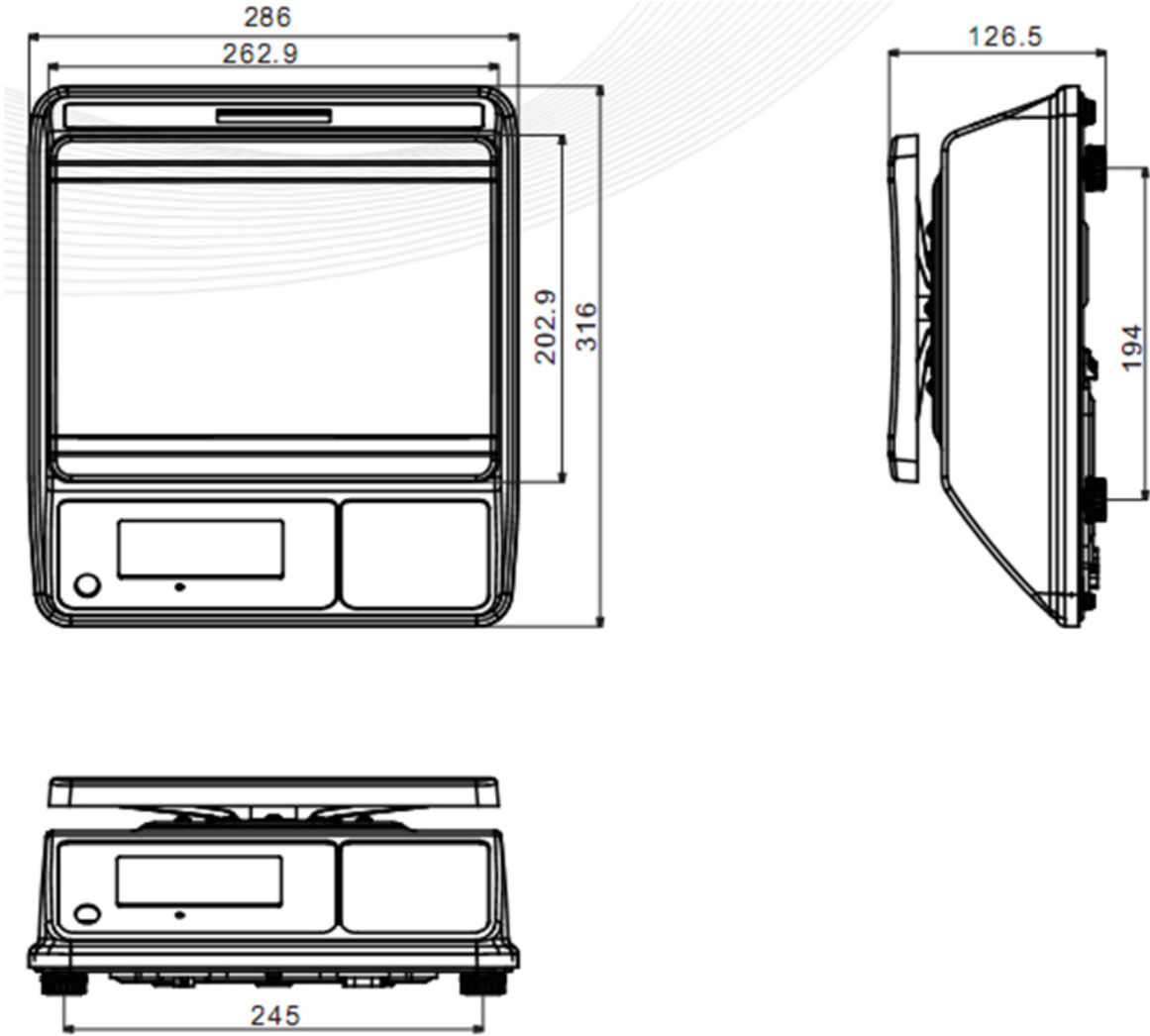

2 Appliance overview





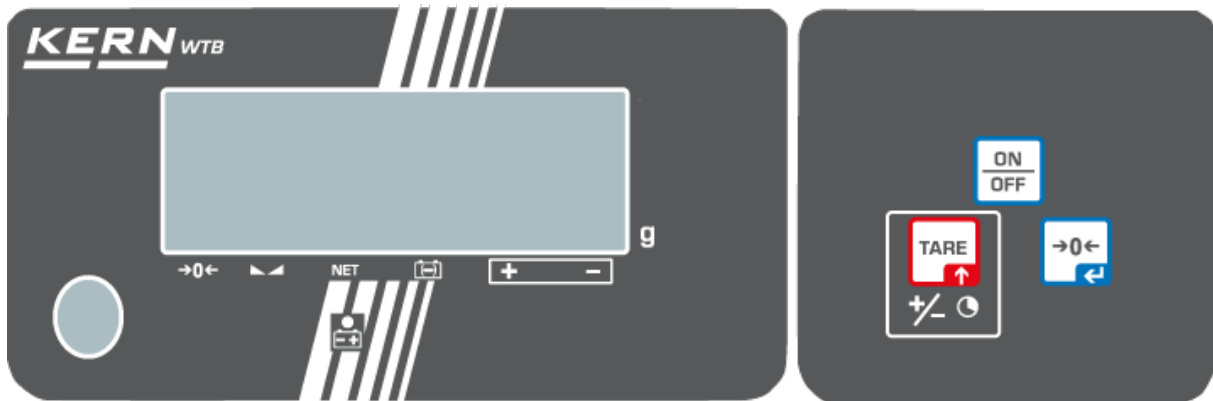

- 1 Weighing plate
- 2 Keyboard
- 3 Bubble level
- 4 Display

2.1 Overview of display







Rear view:



Display	Description	Description
→0←	Zeroing display	Should the balance not display exactly zero despite empty scale pan, press the  button. The balance will be set to zero after a short standby time.
	Stability display	Scales are in a steady state
NET	Net weight display	Net weight will be displayed
	Capacity display Rechargeable battery	Triangle above the capacity indicator appears when the battery capacity is almost exhausted
	Display Weighing with tolerance range	Triangle above "+": upper limit value Triangle above "-": lower limit value
	Power supply connected	Lights with power supply via power supply unit, then the battery is being charged
kg	Display Weighing unit kg	Displayed weight in kg

2.2 Keyboard overview

Key	Description	Function	in menu
	ON/OFF-switch	Turn on/off	
	TARE button	<ul style="list-style-type: none"> Tare balance Weighing with tolerance range 	<ul style="list-style-type: none"> Call up menu Change to the next menu item /parameter
	Zero setting key	Set balance to zero	<ul style="list-style-type: none"> Select menu item / parameter
 + 	Push TARE + reset button simultaneously	Switch-over units	

3 Basic Information (General)

3.1 Proper use

The balance you purchased is intended to determine the weighing value of material to be weighed. It is intended to be used as a “non-automatic balance”, i.e. the material to be weighed is manually and carefully placed in the centre of the weighing pan.. As soon as a stable weighing value is reached the weighing value can be read.

3.2 Improper Use

Do not use balance for dynamic weighings. In the event that small quantities are removed or added to the material to be weighed, incorrect weighing results can be displayed due to the “stability compensation“. (Example: Slowly draining fluids from a container on the balance.)

Do not leave permanent load on the weighing pan. This may damage the measuring system.

Impacts and overloading exceeding the stated maximum load (max) of the balance, minus a possibly existing tare load, must be strictly avoided. Balance may be damaged by this.

Never operate balance in explosive environment. The serial version is not explosion protected.

The structure of the balance may not be modified. This may lead to incorrect weighing results, safety-related faults and destruction of the balance.

The balance may only be used according to the described conditions. Other areas of use must be released by KERN in writing.

3.3 Warranty

Warranty claims shall be voided in case

- Our conditions in the operation manual are ignored
- The appliance is used outside the described uses
- The appliance is modified or opened
- Mechanical damage or damage by media, liquids, natural wear and tear
- The appliance is improperly set up or incorrectly electrically connected
- The measuring system is overloaded

3.4 Monitoring of Test Resources

In the framework of quality assurance the measuring-related properties of the balance and, if applicable, the testing weight, must be checked regularly. The responsible user must define a suitable interval as well as type and scope of this test. Information is available on KERN's home page (www.kern-sohn.com) with regard to the monitoring of balance test substances and the test weights required for this. In KERN's accredited DKD calibration laboratory test weights and balances may be calibrated (return to the national standard) fast and at moderate cost.

4 Basic Safety Precautions

4.1 Pay attention to the instructions in the Operation Manual



Carefully read this operation manual before setup and commissioning, even if you are already familiar with KERN balances.

4.2 Personnel training

The appliance may only be operated and maintained by trained personnel.

5 Transport and storage

5.1 Testing upon acceptance

When receiving the appliance, please check packaging immediately, and the appliance itself when unpacking for possible visible damage.

5.2 Packaging / return transport



- ⇒ Keep all parts of the original packaging for a possibly required return.
- ⇒ Only use original packaging for returning.
- ⇒ Prior to dispatch disconnect all cables and remove loose/mobile parts.
- ⇒ Reattach possibly supplied transport securing devices.
- ⇒ Secure all parts such as the glass wind screen, the weighing platform, power unit etc. against shifting and damage.

6 Unpacking, Setup and Commissioning

6.1 Installation Site, Location of Use

The balances are designed in a way that reliable weighing results are achieved in common conditions of use.

You will work accurately and fast, if you select the right location for your balance.

Therefore, observe the following for the installation site:

- Place scales on a stable, even surface;
- Avoid extreme heat as well as temperature fluctuation caused by installing next to a radiator or in the direct sunlight;
- Protect the balance against direct draughts due to open windows and doors;
- Avoid jarring during weighing;
- Protect the balance against high humidity, vapours and dust;
- Do not expose the device to extreme dampness for longer periods of time. Non-permitted condensation (condensation of air humidity on the appliance) may occur if a cold appliance is taken to a considerably warmer environment. In this case, acclimatize the disconnected appliance for ca. 2 hours at room temperature.
- Avoid static charge of goods to be weighed or weighing container.

Major display deviations (incorrect weighing results) may be experienced should electromagnetic fields (e.g. due to mobile phones or radio equipment), static electricity accumulations or instable power supply occur. Change location or remove source of interference.

6.2 Unpacking and placing

Carefully remove the balance from the packaging, remove plastic cover and setup balance at the intended workstation.

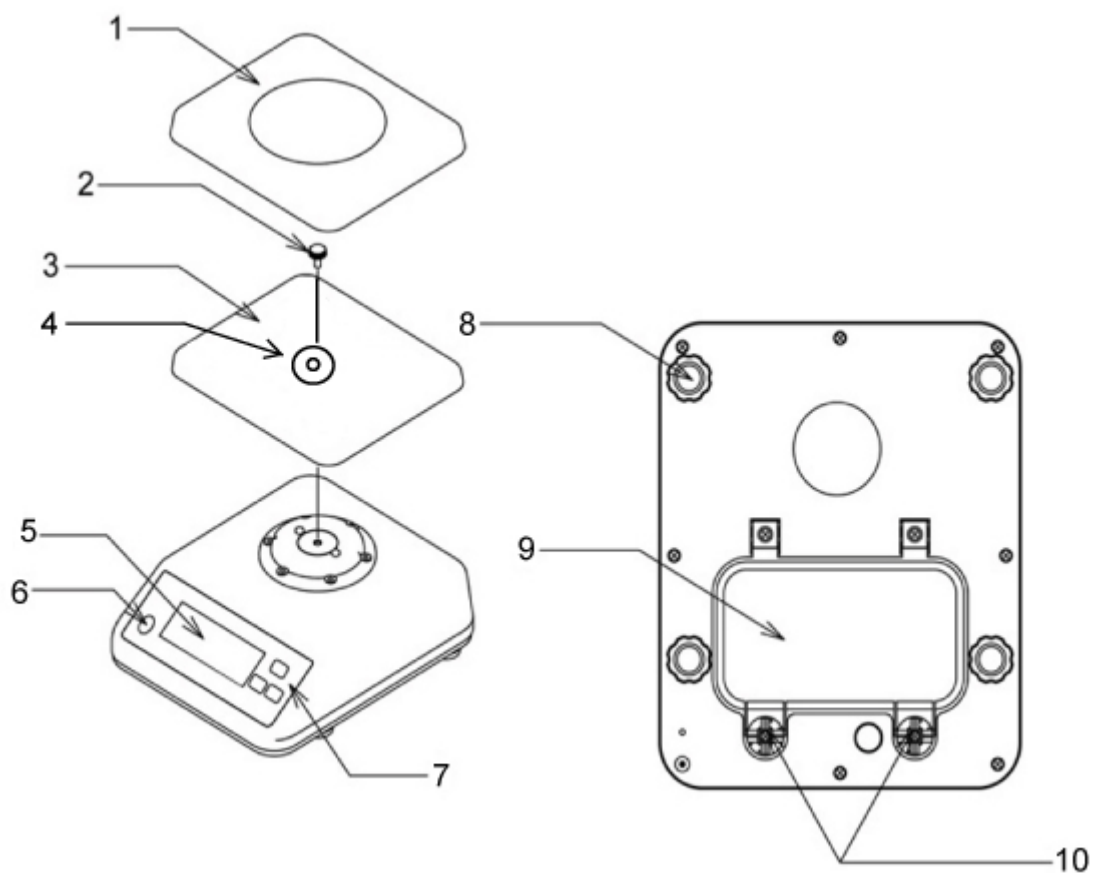

- 1 Weighing pan
- 2 Locking screw
- 3 Carrier weighing plate
- 4 Shim
- 5 Display
- 6 Bubble level
- 7 Keyboard
- 8 Footscrews
- 9 Rechargeable battery compartment cover
- 10 Screws of battery compartment cover

Level balance with foot screws until the air bubble of the water balance is in the prescribed circle.

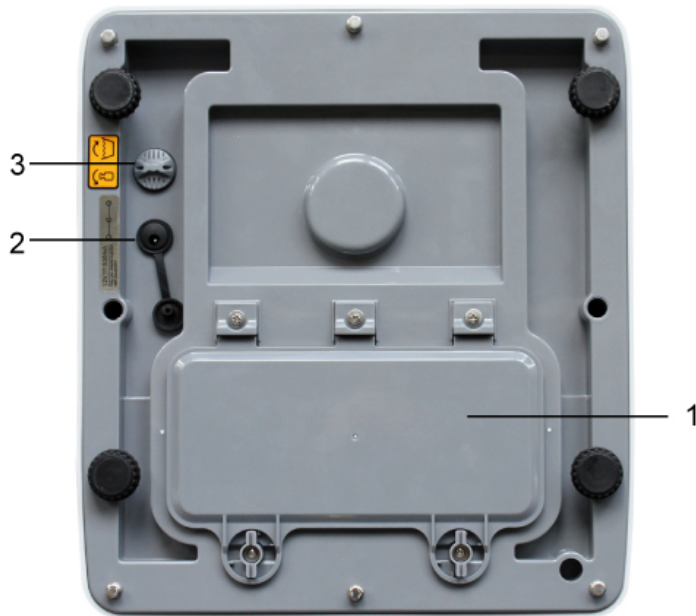
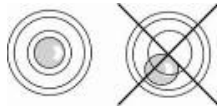

- 1 Rechargeable battery compartment
- 2 Mains port
- 3 Pressure compensation screw

Pressure compensation screw:



[1]

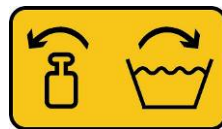

i On the lower side of the balance there is a pressure compensation screw [1] which has to be opened for the weighing process. Fasten the screw before cleaning the balance.



Membrane for degree of protection IP65

6.2.1 Scope of delivery

Serial accessories:

- Balance
- Weighing pan
- Carrier weighing plate
- Fastening screw of the carrier weighing plate
- Operating instructions
- Hexagonal socket wrench

6.3 Rechargeable battery operation (optional)

The rechargeable battery is charged via the delivered power supply.

The operating time of the rechargeable battery with background illumination is 30h, without that it is 50 hrs. Charging time until complete recharging 12h.

In the menu you can activate the AUTO-OFF function [time off], see chap. 9.2.

According to menu settings, the balance switches automatically off in order to spare the battery.

Insert rechargeable battery:

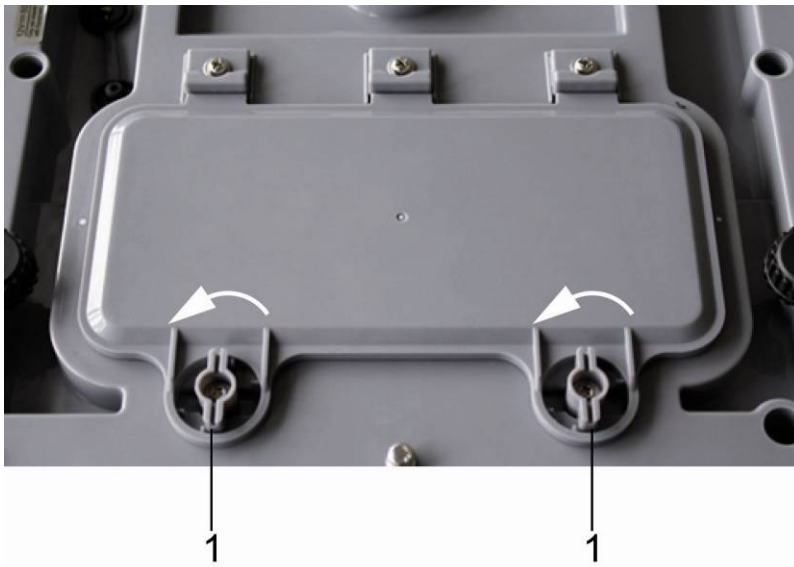

- ⇒ Remove any adherent moisture from the balance
- ⇒ Rotate both levers (1) 90 degrees to the left

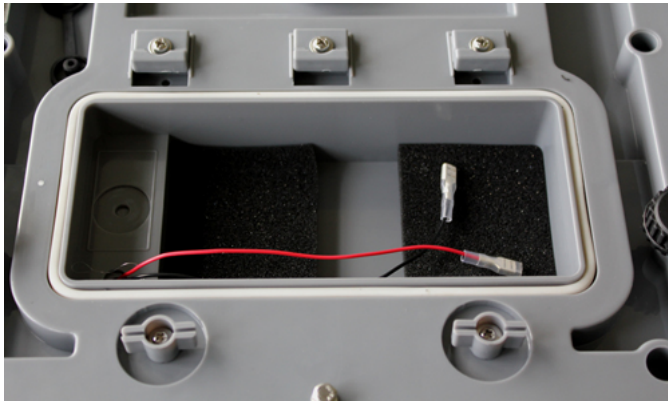

⇒ Remove battery compartment cover and the foam pieces

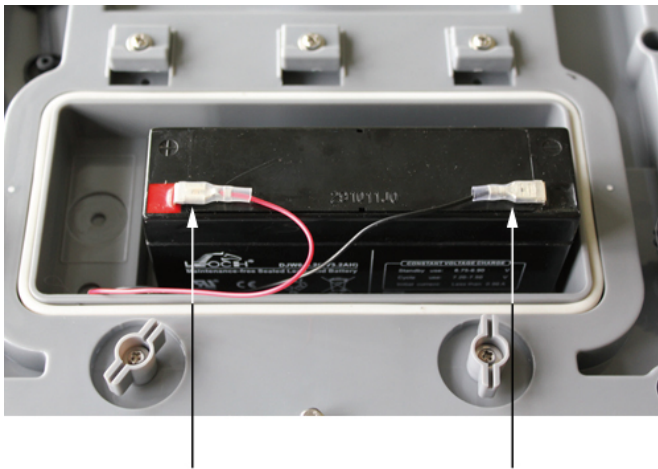

⇒ Connecting the rechargeable battery



Watch the colours:

Red on red !

Black on black!

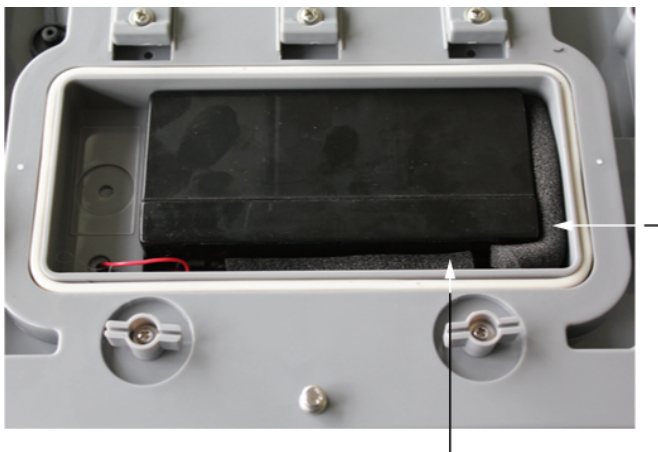

⇒ Insert the rechargeable battery in a manner that it cannot slip (fasten with a rubber foam mat)



Ensure that the cables are not squeezed.

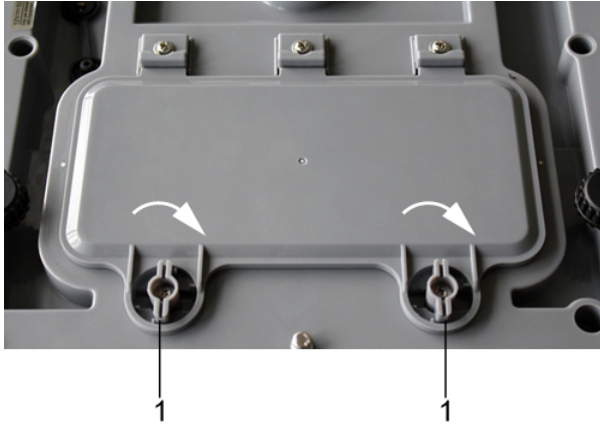

- ⇒ Close the rechargeable battery cover
- ⇒ Rotate both levers (1) 90 degrees to the right

If in the display the triangle ▼ appears above the capacity display , the rechargeable battery is nearly exhausted. Connect power pack, the rechargeable battery is loaded.



Avoid excess pressure on the balance in order to avoid damaging it, particularly as it is supported by the weighing plate.

6.3.1 Mains connection during rechargeable battery operation



During the rechargeable battery operation ensure that the mains connection is covered with a rubber cap.
Only by this the type of protection IP65 is ensured.



6.4 Initial Commissioning

In order to obtain exact results with the electronic balances, your balance must have reached the operating temperature (see warming up time chap. 1).

For this warm-up period the scale must be connected to the power supply (batteries). The accuracy of the balance depends on the local acceleration of gravity.

Strictly observe hints in chapter Adjustment.

6.5 Type of protection IP65

The KERN WTB meets the requirements for **IP65 protection type**.

Suitable for a short-time contact with liquids. For cleaning use damp cloth. Dust-tight.

7 Adjustment

As the acceleration value due to gravity is not the same at every location on earth, each balance must be coordinated - in compliance with the underlying physical weighing principle - to the existing acceleration due to gravity at its place of location (only if the balance has not already been adjusted to the location in the factory). This adjustment process must be carried out for the first commissioning, after each change of location as well as in case of fluctuating environment temperature. To receive accurate measuring values it is also recommended to adjust the balance periodically in weighing operation.

7.1 Adjustment

Carry out adjustment as close as possible to the maximum load of the scales (see chap. 1 „Technical data“). The accuracy of the adjustment weight must correspond approximately to or, if possible, be better than, the readability **d** of the balance.

Information about test weights you will find in the internet under <http://www.kern-sohn.com>

Procedure when adjusting:

Observe stable environmental conditions. A warming up time (see chapter 1) is required for stabilization.

7.1.1 Adjustment non verifiable models

Display

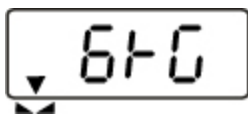
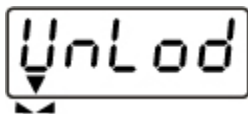
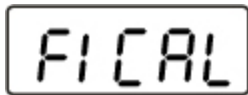
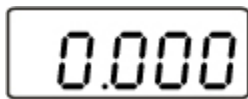

(example)

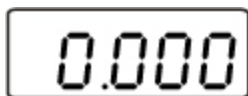

Operation

- ⇒ Start balance by pressing
- ⇒ While the balance carries out a self test (00...- 99...), press and keep pressed until „F1 CAL“ appears on the display.

- ⇒ Press ; in the display appears „UnLod“. Wait for the triangle above the stability symbol, then press , the value of the last-used adjustment weight is displayed. Exp: „6 kg“. If necessary, change value by .

- ⇒ Place the adjustment weight
- ⇒ Wait for the triangle above the stability symbol

- ⇒ Press While the balance carries out a self-test, take away the adjustment weight

The balance changes over to zero display.
Now the process of adjustment is completed.

If the display shows an error message or an incorrect value, repeat adjustment process. If the error message remains, please contact your dealer.

7.1.2 Adjustment of verifiable models

i In verified balances the menu is locked by the verification switch.

To disable the access lock, destroy the seal and actuate the adjustment switch. Position of the adjustment switch see chapter 7.2.1

Attention:

After destruction of the seal the balance must be re-verified by an authorised agency and a new verification wire/seal mark fitted before it can be reused for applications subject to verification.

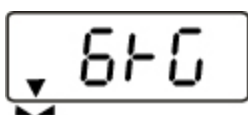
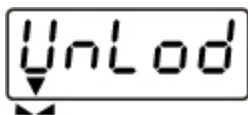
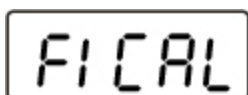
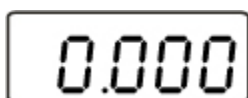

Display

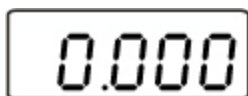
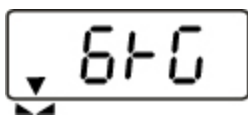

(example)





Operation

- ⇒ Start balance by pressing .
- ⇒ While the balance carries out a self test (00...- 99...), press  and keep pressed until „F1 CAL“ appears on the display.
- ⇒ Actuate the adjustment switch on the lower side of the balance

- ⇒ Press  in the display appears „UnLod“.

- ⇒ Press  anew
The weighing value is displayed.

- ⇒ Press  to enter the value of the adjustment weight (see chapter 1)
- ⇒ Place the adjustment weight
- ⇒ Press 
While the balance carries out a self-test, take away the adjustment weight

The balance changes over to zero display.
Now the process of adjustment is completed.

7.2 Verification

General introduction:

According to EU directive 2014/31EU balances must be officially verified if they are used as follows (legally controlled area):

- a) For commercial transactions if the price of goods is determined by weighing.
- b) For the production of medicines in pharmacies as well as for analyses in the medical and pharmaceutical laboratory.
- c) For official purposes
- d) For manufacturing final packages

In cases of doubt, please contact your local trade in standard.

Verification notes:

An EU type approval exists for balances described in their technical data as verifiable. If a balance is used where obligation to verify exists as described above, it must be verified and re-verified at regular intervals.

Re-verification of a balance is carried out according to the respective national regulations. The validity for verification of balances in Germany is e.g. 2 years.

The legal regulation of the country where the balance is used must be observed!



Verification of the balance is invalid without the seal.

The seal marks attached on verified balances point out that the balance may only be opened and serviced by trained and authorised specialist staff. If the seal mark is destroyed, verification loses its validity. Please observe all national laws and legal regulations. In Germany a re-verification will be necessary.

7.2.1 Adjustment switch and seals

After a verification the balance is sealed at the indicated positions.

Position of the official seals:

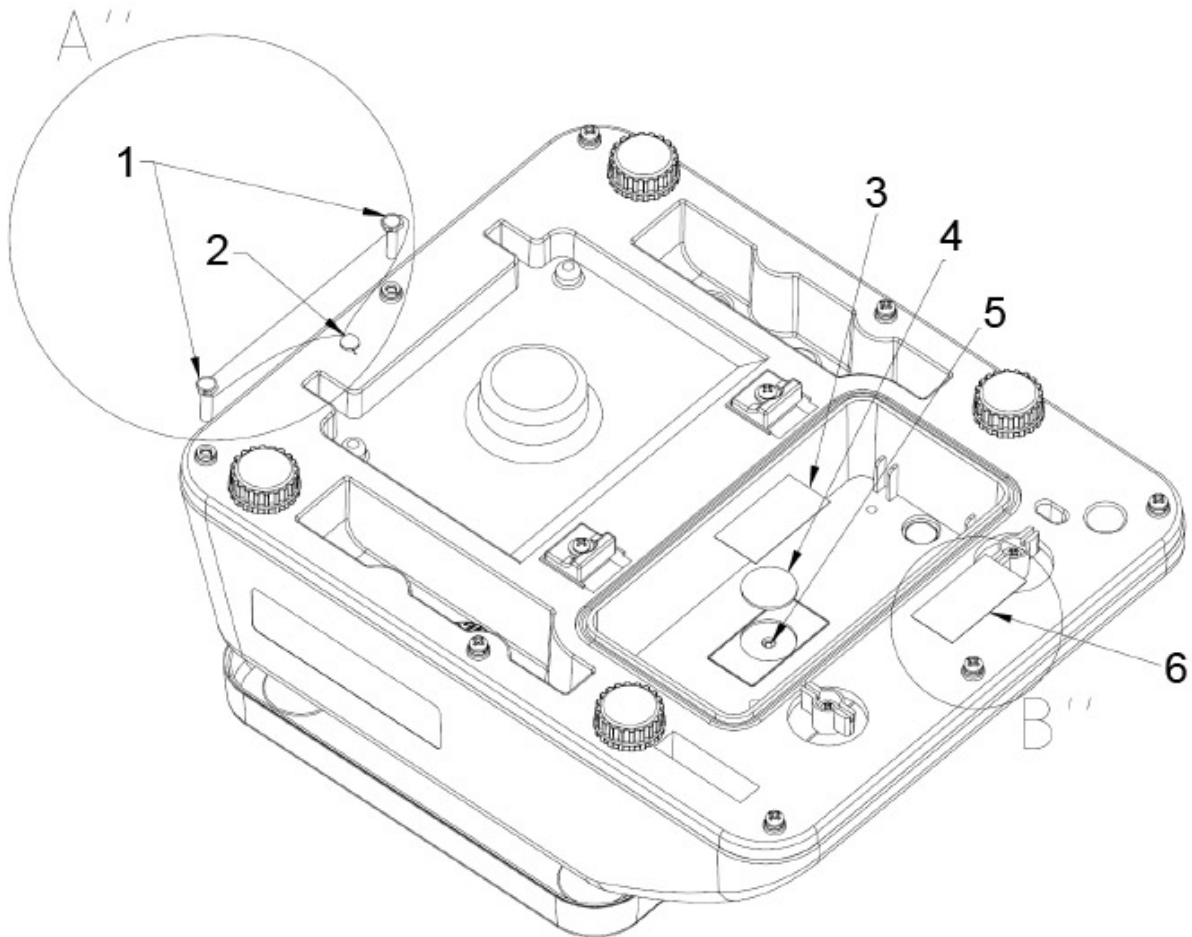

1. Verification wire fastening
2. Verification wire fastening
3. Self-destroying seal mark
4. Cover of adjustment switch
5. Adjustment switch
6. Self-destroying seal mark

8 Operation

8.1 Weighing



⇒

Start balance by pressing



The balance will carry out a self-test

When the weight display shows "0.0" and the triangle symbol ▼ above the stability display ▲▲ appears, the scale is ready for weighing.



- However, you can reset the weighing scale to zero by pressing

the  key.

⇒

Switch off balance using



The "0.0" display disappears and the scales are switched off.

8.2 Taring

The tare weight of any preloads can be deducted by pressing a button so that the actual weight of the weighed material is displayed in subsequent weighings.

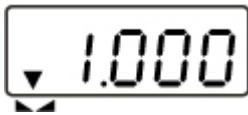

(example)



⇒

Put on weighing receptacles and press



The zero display appears, and above the reset symbol →0← the stability symbol ▲▲ and the net weight symbol **NET** the triangle ▼ appears.

The weight of the container is now internally saved.

⇒

Place goods to be weighed in the weighing container.

The **net weight** of the goods to be weighed is displayed.



(example)





The weight of the weighing container will be displayed as a minus number (=gross weight) after removing the weighing container.

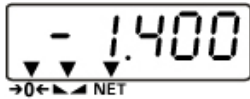

The tare weight is saved until it is deleted. Remove the load from the balance and press . The zero display appears and the triangle ▼ above the net weight symbol **NET** vanishes.

Gross weight:





- ⇒ Press  as long as the weighing container and the object to be weighed are on the weighing plate.
- ⇒ Remove the object to be weighed as well as the weighing container.
The gross weight is displayed as a negative value.

8.3 Background illumination

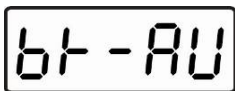

- ⇒ In weighing mode  press for about 3 seconds, "bK-AU" appears.



- ⇒ Press  to select background illumination automatically off („bK-AU“) and background illumination off („bK-oF“).



- ⇒ Press  to confirm selected setting.



The balance changes into weighing mode

8.4 Weighing with tolerance range

You can set an upper or lower limit when weighing with tolerance range and thus ensure that the weighed load remains exactly within the set tolerance limits.

Settings:



⇒ In weighing mode press  for about 3 seconds, the display for entering the upper limit appears. The left digit blinks. A triangle appears above the "+" symbol. Moreover, the background of the screen turns red.





⇒ Enter upper limit value, the active position blinks.



(example)

Mit  Correct the numerical value by

decimal using . If the last digit is entered, confirm input

by , the upper limit value is hereby saved.

The display changes to the prompt for entering the lower limit value.

The colour of the display then changes to orange.



(example)

⇒ Now enter the lower limit value as described above and

confirm input using . The lower limit value is thus entered. The balance changes into weighing mode.



Audio signal:

The acoustic signal depends on the settings in menu block „F9 BEP“.

Options:

- BEP 0 Acoustic signal turned off
- BEP 1 An acoustic signal sounds when load is within tolerance limits
- BEP 2 An acoustic signal sounds when load is beyond tolerance limits

Optical signals:

The triangle above the "+" - or the "-" symbol indicates whether the sample weighed is within the tolerance range:

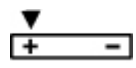
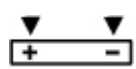
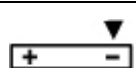
	Goods to be weighed above tolerance limit
	Goods to be weighed within tolerance range
	Goods to be weighed below tolerance limit



Traffic light function:

The indicator lights up in red, green and orange, depending on the area in which your sample is:

red	Goods to be weighed above tolerance limit
green	Goods to be weighed within tolerance range
orange	Goods to be weighed below tolerance limit

Weighing with tolerance range

- ⇒ Tare when using a weighing container
- ⇒ Put on goods to be weighed, tolerance control is started



Load below specified tolerance	Load within specified tolerance	Load exceeds specified tolerance
		
orange background	green background	red background

9 The menu

9.1 Navigation in the menu

In verified balances the menu is locked by the verification switch.



⇒ Switch on the scales by  and during the balance's self-test, press  until "F1 CAL" is displayed.





⇒ Use  to change to the next menu item

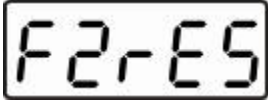
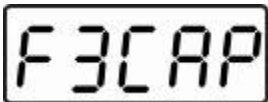

⇒ Select menu item using 

⇒ Use  to change between the individual parameters

⇒ Select the desired parameter using 

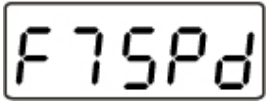
9.2 Menu overview (locked in verifiable models)

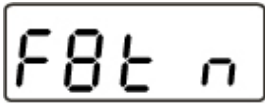
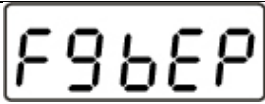
Menu item	Function	
	Adjustment process.	
	3000 6000 dual	Resolution Please do not change default setting
	1.5 kg 3 kg 6 kg 15 kg 25 kg 30 kg	Max load Do not change the default setting
	not documented	
	3 min 5 min 15 min off	Auto-OFF function, adjustable between off, 3, 5 and 15 minutes
	not documented	
	SP 7.5 SP 15 SP 30 SP 60	Display speed Do not change the default setting

	Multi-Tare function: 0 tare Multi-Tare function disabled P tare Multi-Tare function enabled	
	Acoustic signal in tolerance weighing mode	
	bEP 0	Acoustic signal turned off
	bEP 1	Acoustic signal when weighed material is within the tolerance range
	bEP 2	Acoustic signal when weighed material is outside the tolerance range
	Return to weighing mode	

9.3 Set auto-OFF function

F1CAL

⇒ Switch on the scales by  and during the balance's self-test, press  until "F1 CAL" is displayed.

F5oFF

⇒ Press  repeatedly until „F5 oFF“ appears

↓

oFF

⇒ Select function using 

↓

⇒ Use  to change between the individual parameters

3nin

⇒ Select the desired parameter using 

↓

5nin

↓

15nin

↓

F5oFF

“F5 oFF“ appears, now the function is enabled

bACK



⇒ Press  repeatedly until “bACK“ appears

⇒ Press 
The balance carries out a restart and changes to weighing mode

9.4 Multi-Tare function

The scale has the ability to tare several times in a row. For this purpose, select the menu item "**F8 tm**" and set the parameter "**P tare**".

10 Error messages

Display	Description	Remedy
	Zero range exceeded	Unload the balance
	A/D converter outside range	Unload the balance; check if the weighing is correctly placed and screwed on

11 Instant help

In case of an error in the program process, briefly turn off the balance and disconnect from power supply. The weighing process must then be restarted from the beginning.

Fault

Possible cause

The displayed weight does not glow.

- The balance is not switched on.
- Batteries are inserted incorrectly or empty
- No batteries inserted.

The displayed weight is permanently changing

- Draught/air movement
- Table/floor vibrations
- Weighing pan has contact with other objects.
- Electromagnetic fields / static charging (choose different location/switch off interfering device if possible)

The weighing value is obviously wrong

- The display of the balance is not at zero
- Adjustment is no longer correct.
- Great fluctuations in temperature.
- The balance is on an uneven surface.
- Electromagnetic fields / static charging (choose different location/switch off interfering device if possible)

Should other error messages occur, switch balance off and then on again. If the error message remains inform manufacturer.

12 Service, maintenance, disposal

12.1 Cleaning

Before cleaning, please remove batteries from the appliance

Please do not use aggressive cleaning agents (solvents or similar agents), but a cloth dampened with mild soap suds. Ensure that no liquid penetrates into the device and wipe with a dry soft cloth.

Loose residue sample/powder can be removed carefully with a brush or manual vacuum cleaner.

Spilled weighing goods must be removed immediately.

12.2 Service, maintenance

The appliance may only be opened by trained service technicians who are authorized by KERN.

Before opening, disconnect from power supply.

12.3 Disposal

Disposal of packaging and appliance must be carried out by operator according to valid national or regional law of the location where the appliance is used.

13 Declaration of Conformity

To view the current EC/EU Declaration of Conformity go to:

www.kern-sohn.com/ce

i The scope of delivery for verified weighing balances (= conformity-rated weighing balances) includes a Declaration of Conformity.