



Nothing but **HEAVY DUTY.**





LDM 50

- | | | |
|---------|------------|------------------------------------|
| click → | GB | Original instructions |
| click → | D | Originalbetriebsanleitung |
| click → | F | Notice originale |
| click → | I | Istruzioni originali |
| click → | E | Manual original |
| click → | P | Manual original |
| click → | NL | Oorspronkelijke gebruiksaanwijzing |
| click → | DK | Original brugsanvisning |
| click → | N | Original bruksanvisning |
| click → | S | Bruksanvisning i original |
| click → | FIN | Alkuperäiset ohjeet |
| click → | GR | Πρωτότυπο οδηγιών χρήσης |
| click → | TR | Orijinal işletme talimatı |
| click → | CZ | Původním návodem k používání |

CONTENTS

Important safety instructions.....	1
Specified Conditions of Use	2
Error Code Table	2
Overview.....	3
Change batteries	4
Corner Pin	4
Belt Clip	4
Function Switch, Measuring Reference, Pythagoras.....	5
Single Distance Measuring.....	6
Permanent / Minimum-Maximum Measuring.....	7
Add / Subtract Measuring	8
Area Measuring	9
Volume Measuring.....	10
Indirect Measuring (Pythagoras 1)	11
Indirect Measuring (Pythagoras 2)	12
Indirect Measuring (Pythagoras 3)	13
Wall Area Measuring (Scenario 1).....	14
Wall Area Measuring (Scenario 2).....	15
Timer	16
Memory.....	16
Basic Description on example of Area measuring (1).....	17
Basic Description on example of Area measuring (2).....	18

IMPORTANT SAFETY INSTRUCTIONS

  Do not use the product before you have studied the Safety instructions and the User Manual.

Laser Classification

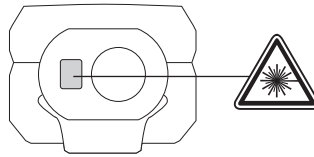

WARNING:

It is a Class 2 laser product in accordance with EN60825-1:2014.



λ 650 nm P<1 mW

WARNING:

Avoid direct eye exposure. The laser beam can cause flash blindness.

Do not stare into the laser beam or direct it towards other people unnecessarily.

Don't dazzle other individuals.

WARNING:

Do not operate the tool around children or allow children to operate the tool.

The reflective surface could reflect the beam back at the operator or other persons.

Keep extremities in a safe distance from the moving parts.

Carry out periodic test measurements. Particularly before, during and after important measurements.

Watch out for erroneous measurements if the product is defective or if it has been dropped or has been misused or modified.

WARNING: Use of controls, adjustments, or the performance of procedures other than those specified in the manual may result in hazardous radiation exposure.

The laser distance measurer has limits of use. (Refer to the "Technical data" section). Attempts to measure outside the maximum and minimum range will cause inaccuracy. Use in adverse conditions including too hot, too cold, very bright sunlight, rain, snow, fog, or other vision restricting conditions will result in inaccurate readings.

When the laser distance measurer is brought into a warm environment from very cold conditions, or vice versa, allow it to come to the surrounding temperature before use.

Always store the laser distance measurer indoors, avoid exposing the tool to shock, continuous vibration or extreme temperatures.

Always keep the tool away from dust, liquids and high humidity. These may damage internal components or affect accuracy.

Do not use aggressive cleaning agents or solutions. Use only a clean, soft cloth for cleaning.

Avoid heavy impact to or dropping of the measuring tool. The accuracy of the tool should be checked before use if it has been dropped or subjected to other mechanical stresses.

Any repair required on this laser product should be performed only by authorised service personnel.

Do not operate the product in explosion hazardous areas or in aggressive environments.

Only use chargers recommended by the manufacturer to charge the batteries.

 Do not dispose of waste batteries, waste electrical and electronic equipment as unsorted municipal waste. Waste batteries and waste electrical and electronic equipment must be collected separately.

Waste batteries, waste accumulators and light sources have to be removed from equipment.

Check with your local authority or retailer for recycling advice and collection point.

According to local regulations retailers may have an obligation to take back waste batteries and Waste electrical and electronic equipment free of charge.

Your contribution to re-use and recycling of waste batteries and waste electrical and electronic equipment helps to reduce the demand of raw materials.

Waste batteries, in particular containing lithium and waste Electrical and electronic equipment contain valuable, recyclable materials, which can adversely impact the environment and the human health, if not disposed of in an environmentally compatible manner.

Delete personal data from waste equipment, if any.

 European Conformity Mark

 British Conformity Mark

 Ukraine Conformity Mark

 EurAsian Conformity Mark

TECHNICAL DATA

Dust and Water resistance	IP54
Receiving Lens	14 mm
Focus	35 mm
Maximum Measuring Range	50 meters (Tolerance : 55m)
Minimum Measuring Range	0.05 meters
Absolute Accuracy @ < 10m	± 1.5 mm (Max)
Repeatability Accuracy @ < 10m	± 1.5 mm (Max Typical, 2σ)
Repeatability Accuracy @ > 10m	Increase ± 0.25 mm / meter (Max Typical, 2σ)
Measurement Time	0.5 s
Display Type	LCD (22.7 mm x 31 mm)
Power Type	AAA 2x (Alkaline Battery)
Battery Life	10000 (Single Measure)
Laser Output Power	0.6 mW ~ 0.95 mW (Class 2, 650nm)
Laser Spot Size	25 x 30 mm @ 16 m (Max)
Laser Class	2
Laser Type	650 nm, < 1 mW
Laser Radiation Vertical Angle	+1 degree
Laser Radiation Horizontal Angle	±1 degree
Device auto off time	180 seconds
Laser auto off time	30 seconds
Operating Temperature Range	-10°C to +50°C
Storage Temperature Range	-25°C to +70°C
Weight without Battery	80 g

SPECIFIED CONDITIONS OF USE

The laser distance measurer can be used for measuring distances and tilts.
Do not use this product in any other way as stated for normal use.

ERROR CODE TABLE

Code	Description	Solution
Err01	Out of measuring range	Measure in a proper range
Err02	Reflect signal is too weak	Choose a better surface
Err03	Out of display range (max value: 99.999) e.g. result of area or volume is out of display range	Check and verify values and steps are correct
Err04	Pythagorean calculation error	Check and verify values and steps are correct
Err05	Battery is low	Install new batteries
Err06	Out of working temperature	Measure in an environment with the specified working temperature
Err07	Ambient light is too strong	Measure in a darker place (shadow target)

Single Pythagoras
Height difference

Measuring Reference

Normal Measuring Mode

Minimum / Maximum for continuous Measure

Addition / Subtraction

ON / MEASURE

- ▶ On
- ▶ Measure
- ▶ Continuous Measurement (push 2 sec)
+ Min / Max Function

ADD / SUBSTRACT

- ▶ Add value
- ▶ Subtract value

AREAS / VOLUMES

- ▶ Area (push 1x)
- ▶ Volume (push 2x)
- ▶ Indirect Surface Measurement (push 3x / 4x)

POWER

- ▶ On
- ▶ Off (push 2 sec)
- ▶ Clear

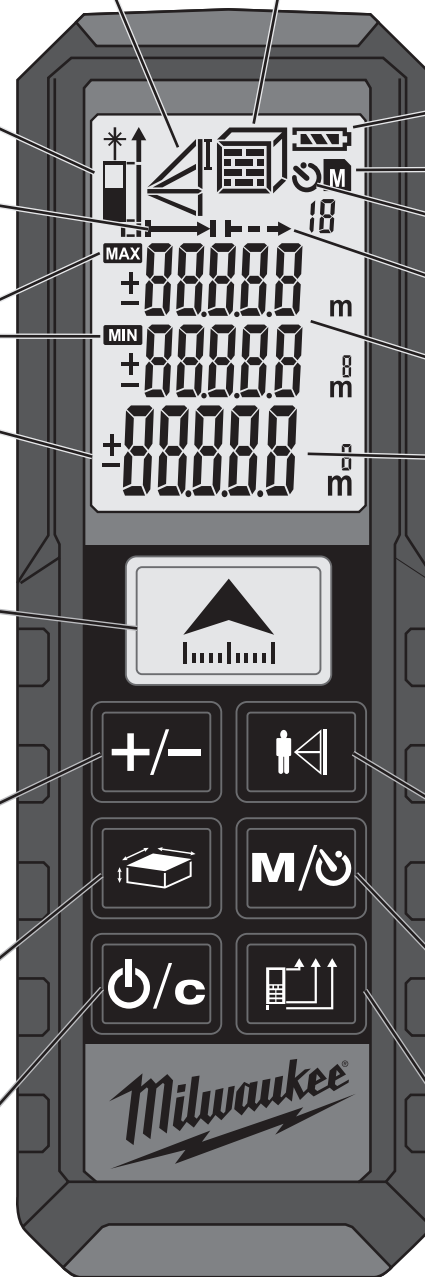

Area/ Volume
Indirect Surface Measurement

Battery Status

Memory

Timer

Continuous measure mode

Among Values

Main Value

PYTHAGORAS

- ▶ Pythagoras 1 (push 1x)
- ▶ Pythagoras 2 (push 2x)
- ▶ Pythagoras 3 (push 3x)

MEMORY

- ▶ Timer 3-15 sec (push 1x)
- ▶ Memory 1-20 (push 1x, 2 sec)
- ▶ Read memory (push repeated)

CHANGE POINT OF MEASURE

- ▶ Front
- ▶ Back (Standard automatical)
- ▶ Corner pin

CHANGE BATTERIES

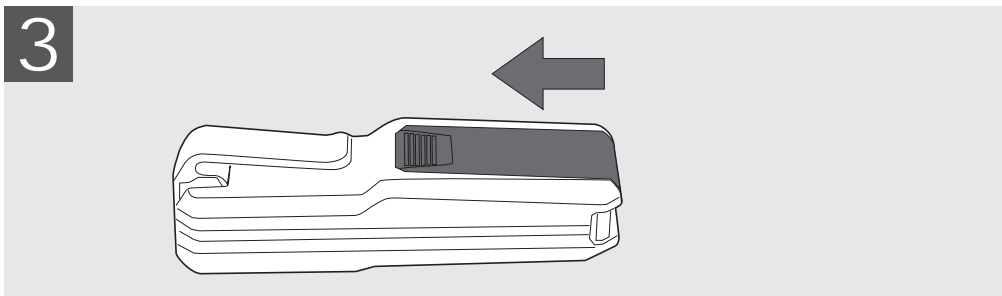
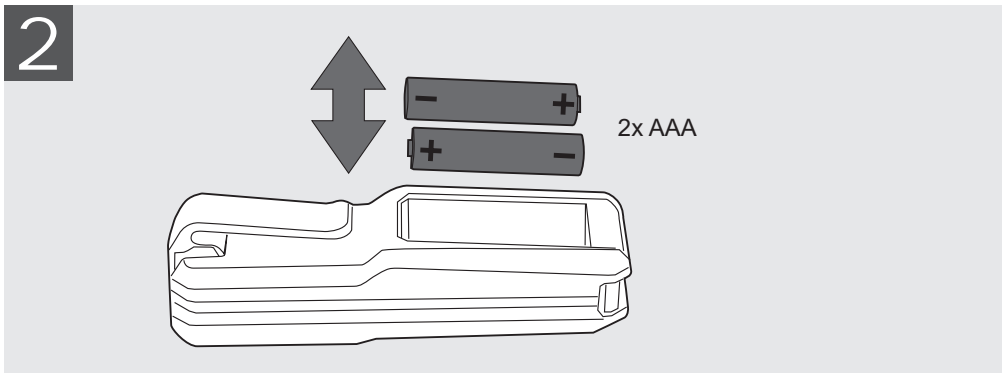
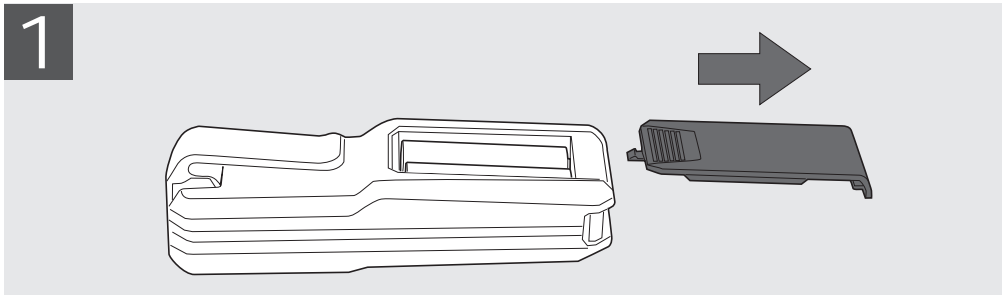
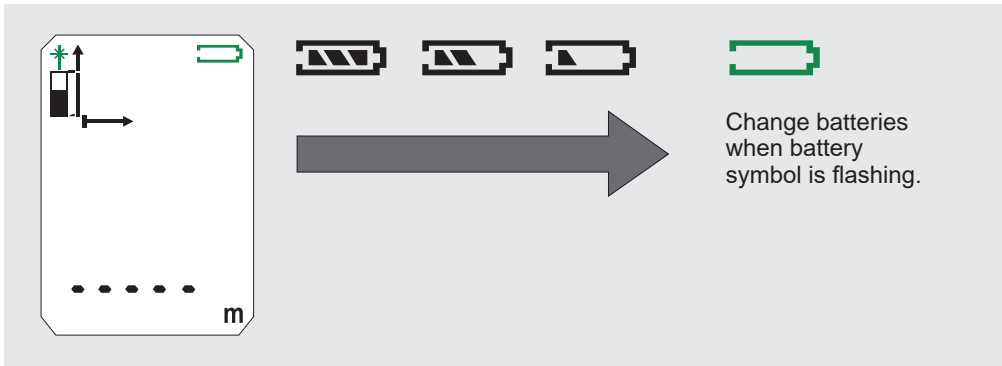

CORNER PIN

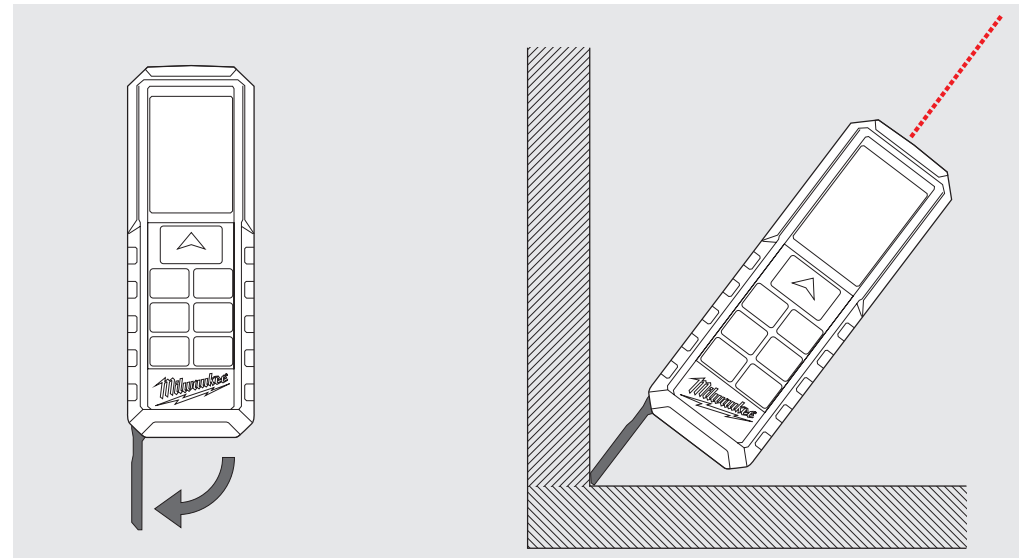

BELT CLIP

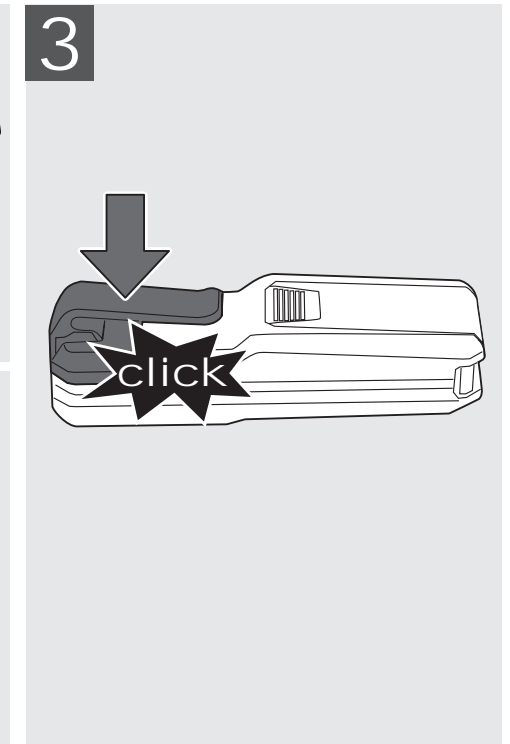
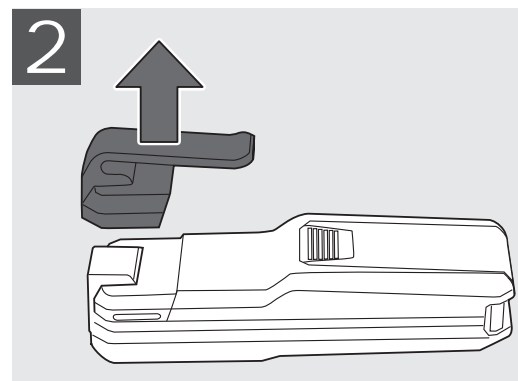
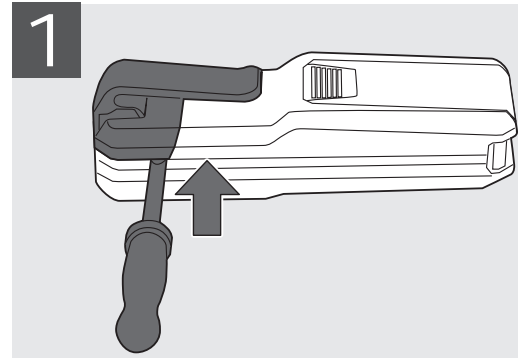

FUNCTION SWITCH, MEASURING REFERENCE, PYTHAGORAS

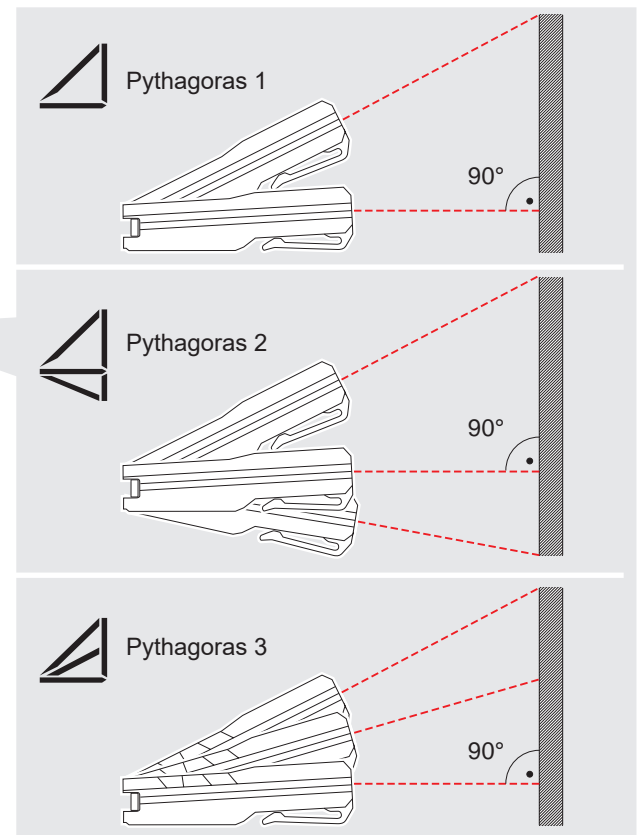
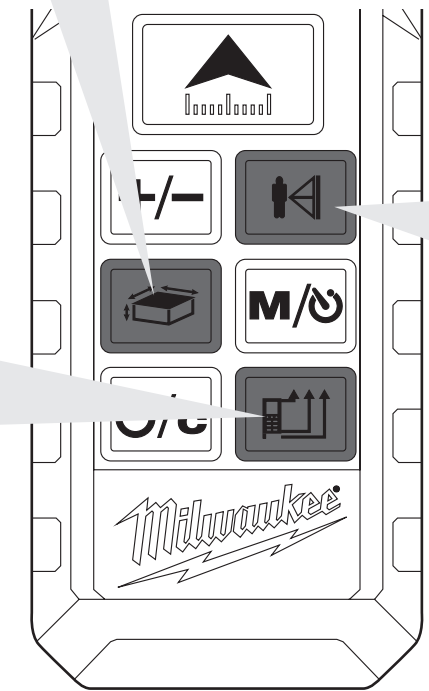
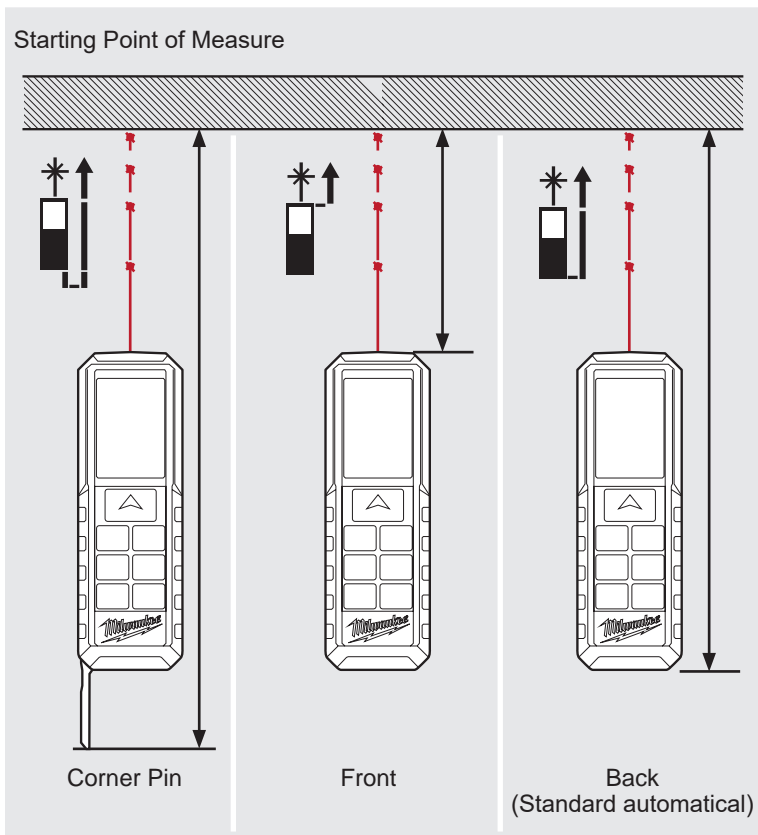
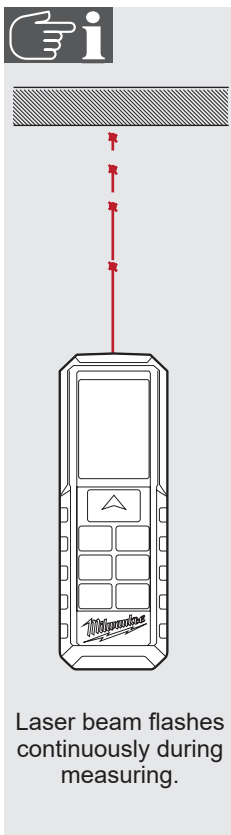
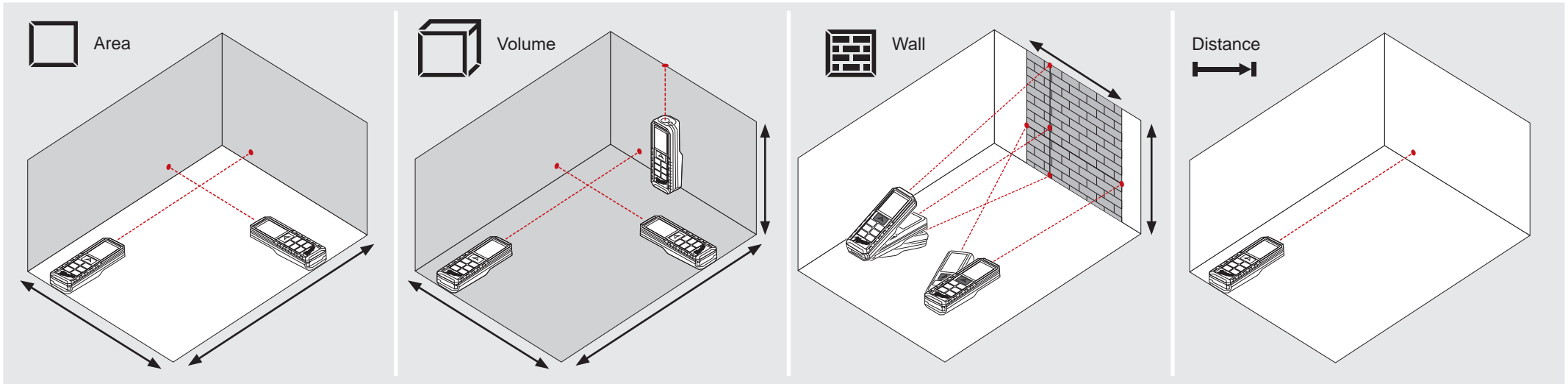

SINGLE DISTANCE MEASURING

0	1	2	3	4

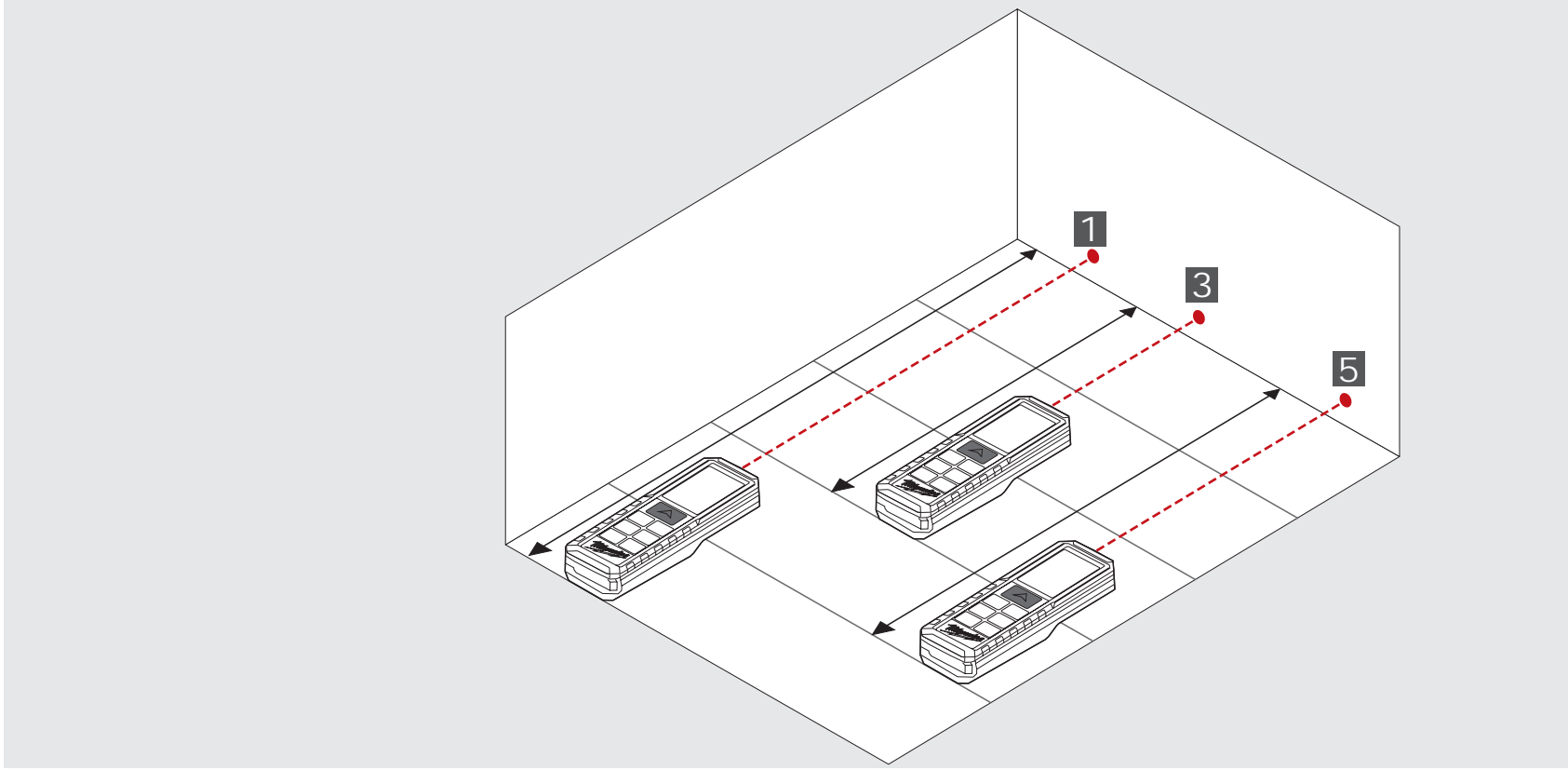

5

PERMANENT / MINIMUM-MAXIMUM MEASURING

0

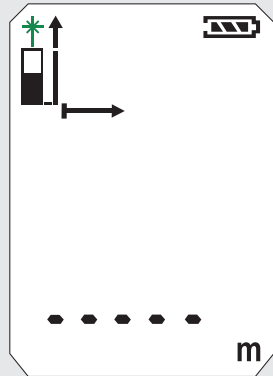

1

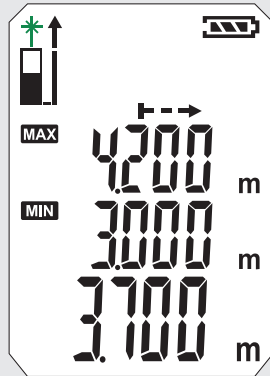

2

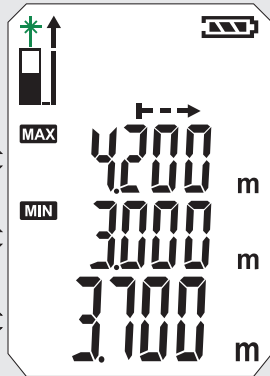

3



Stop
MIN / MAX

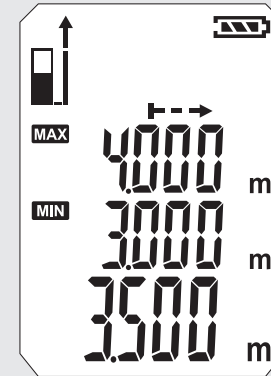

4

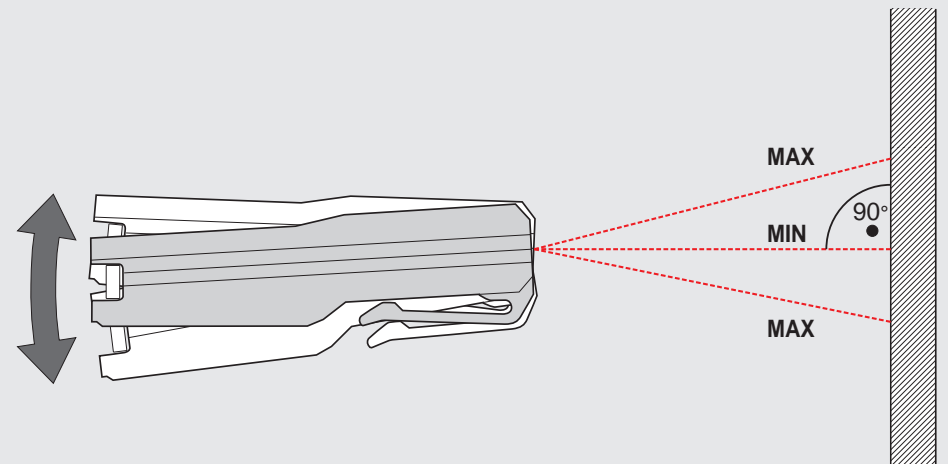
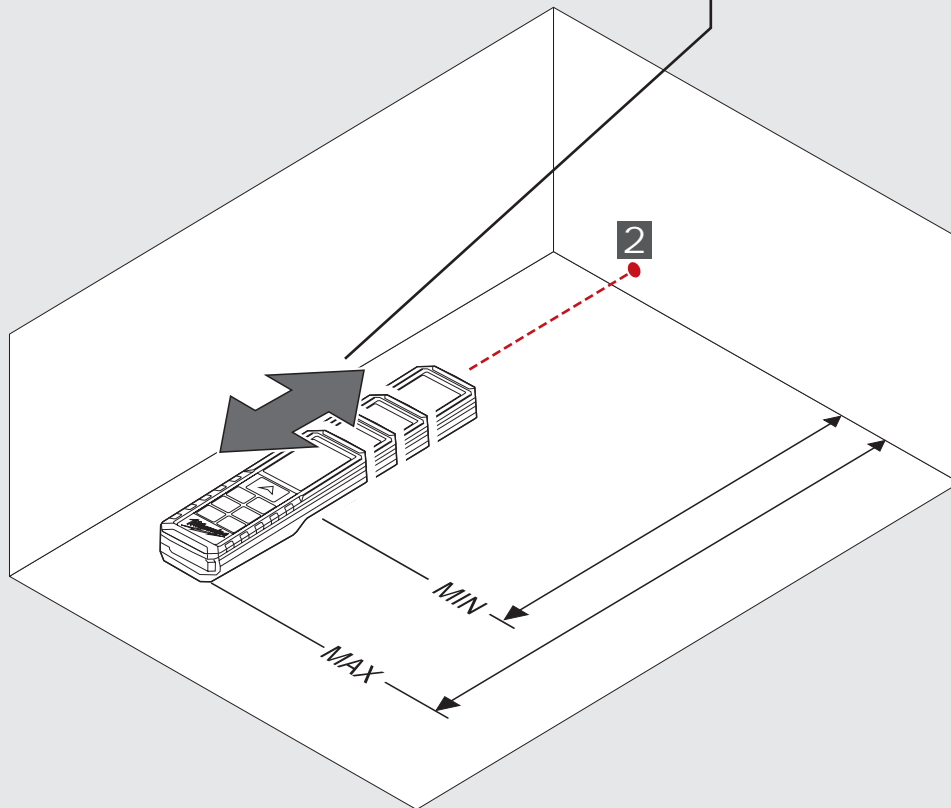
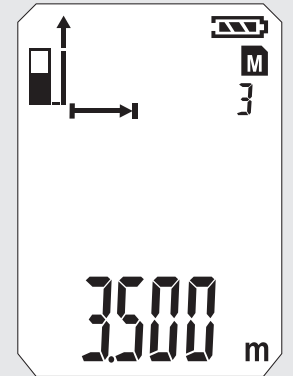

ADD / SUBTRACT MEASURING

0

1

2

3

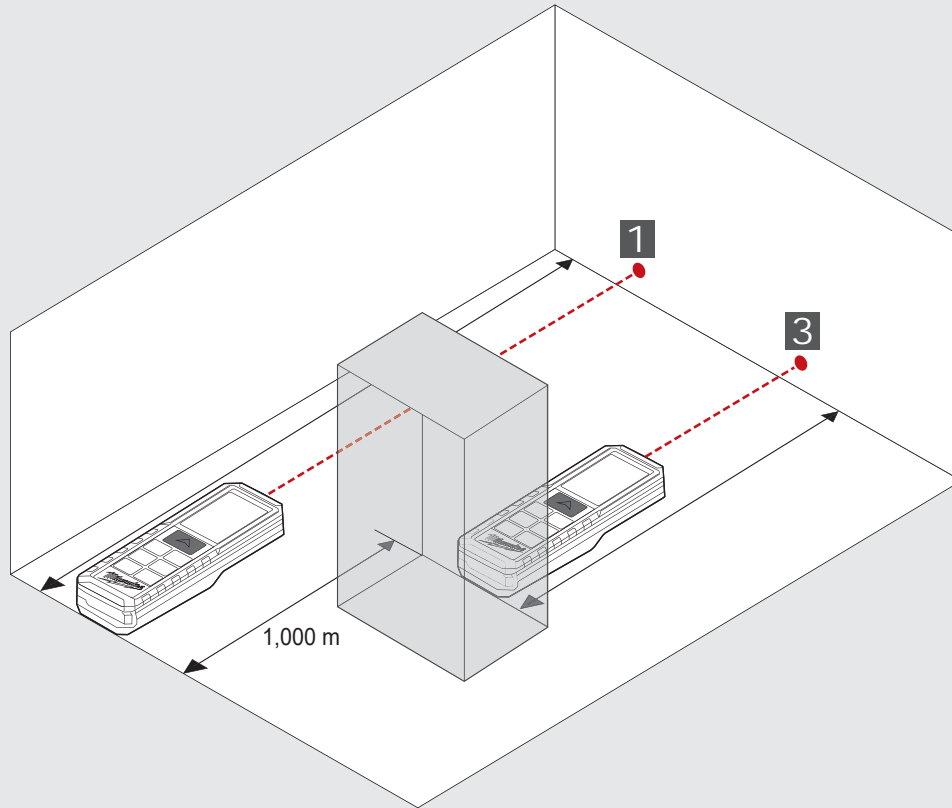
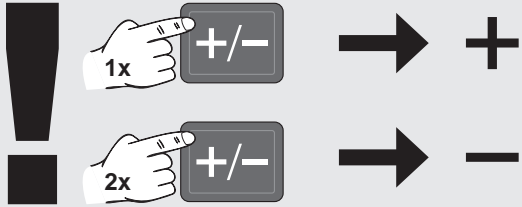
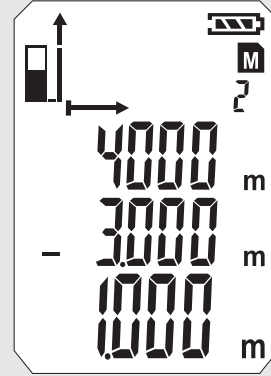
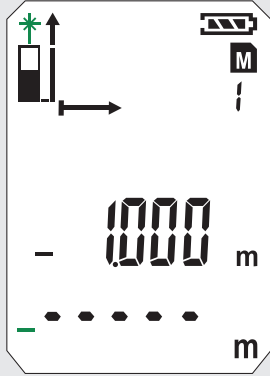
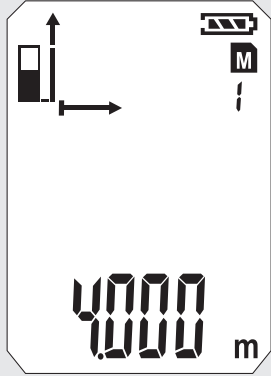
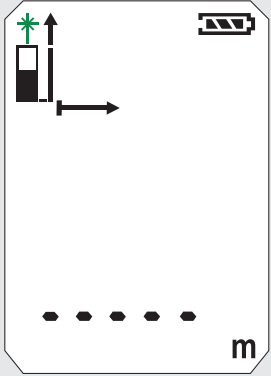
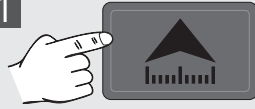

AREA MEASURING

0



1



2

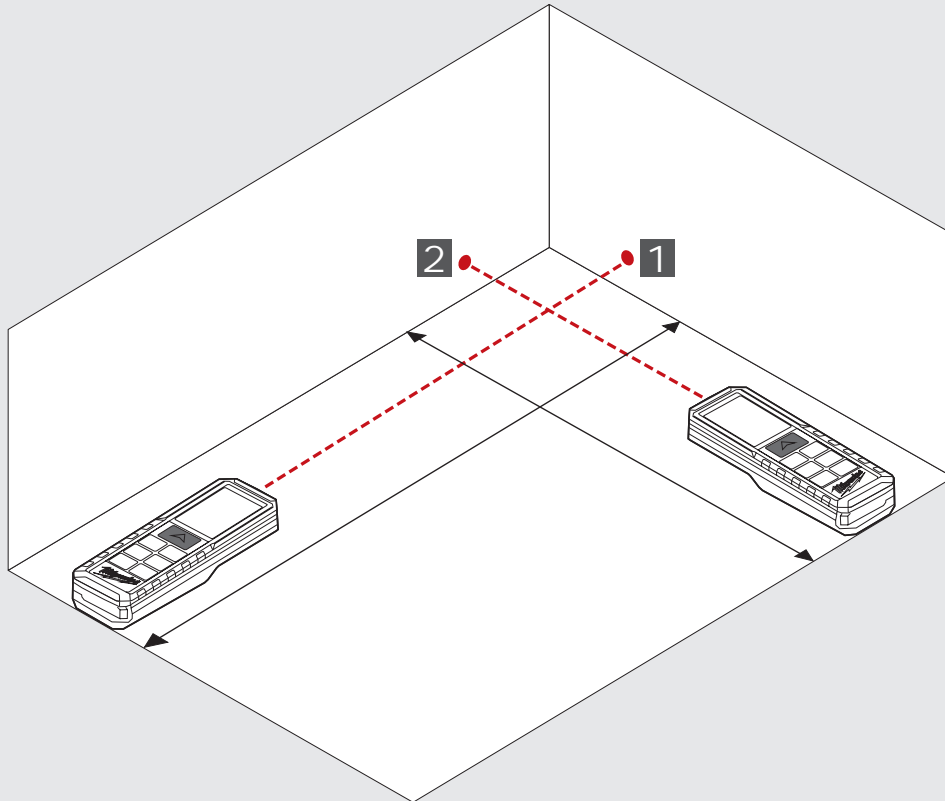
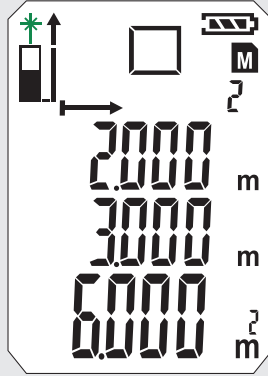
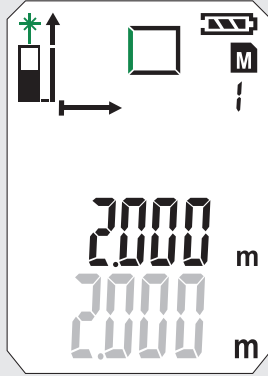
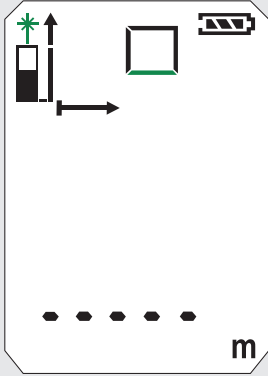



INDIRECT MEASURING (PYTHAGORAS 1)

0







1

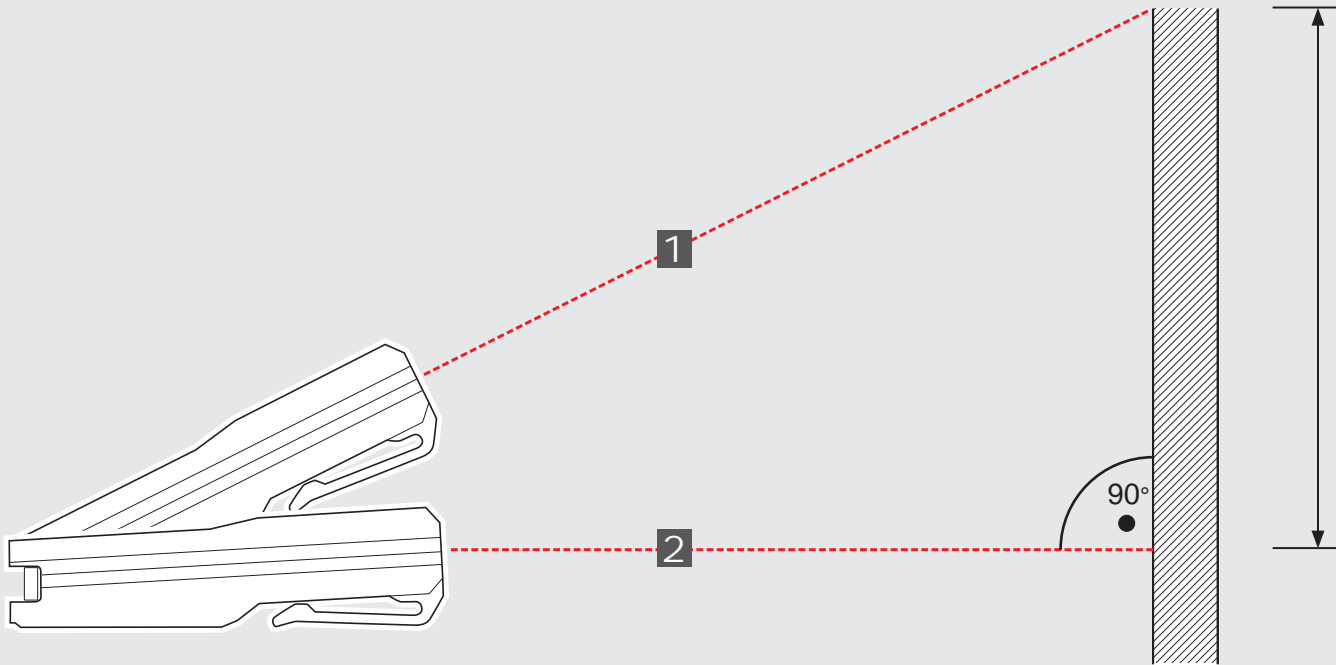
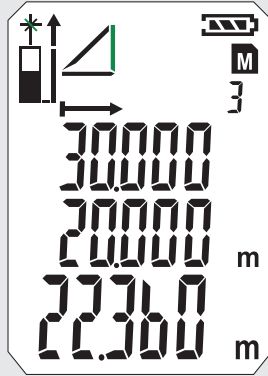
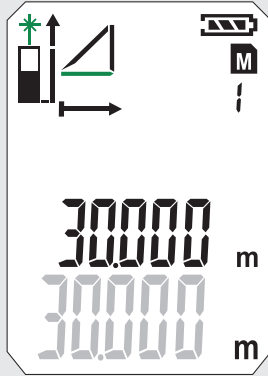
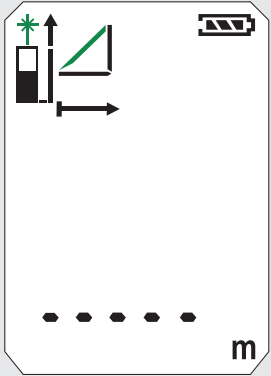

2

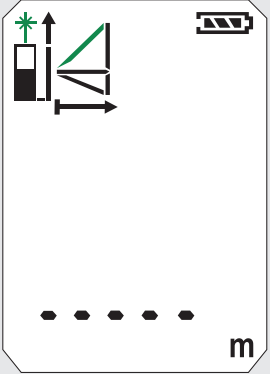
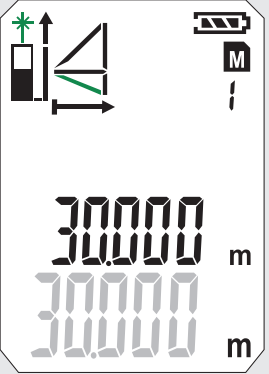
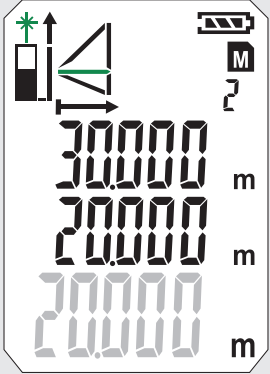
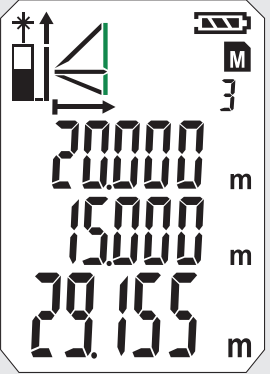

INDIRECT MEASURING (PYTHAGORAS 2)

<p>0</p>  <p>2 x</p>	<p>1</p> 	<p>2</p> 	<p>3</p> 
			

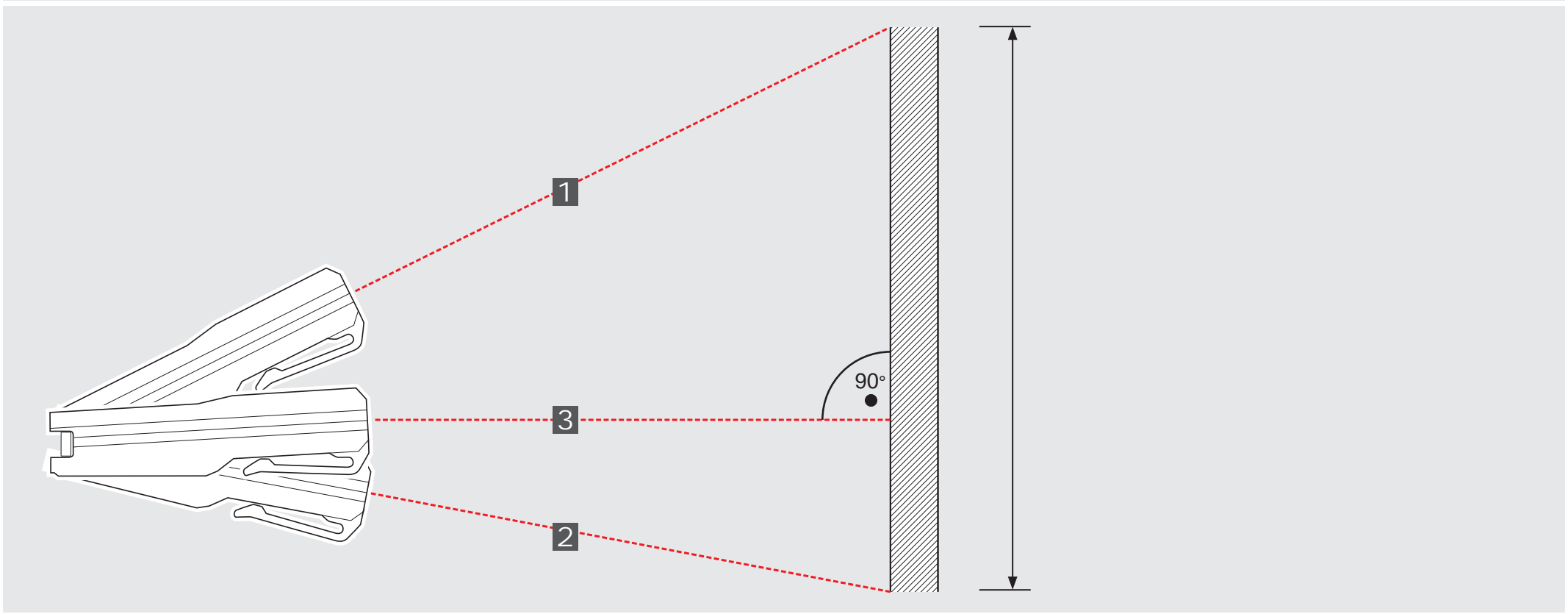

INDIRECT MEASURING (PYTHAGORAS 3)

1



2







3

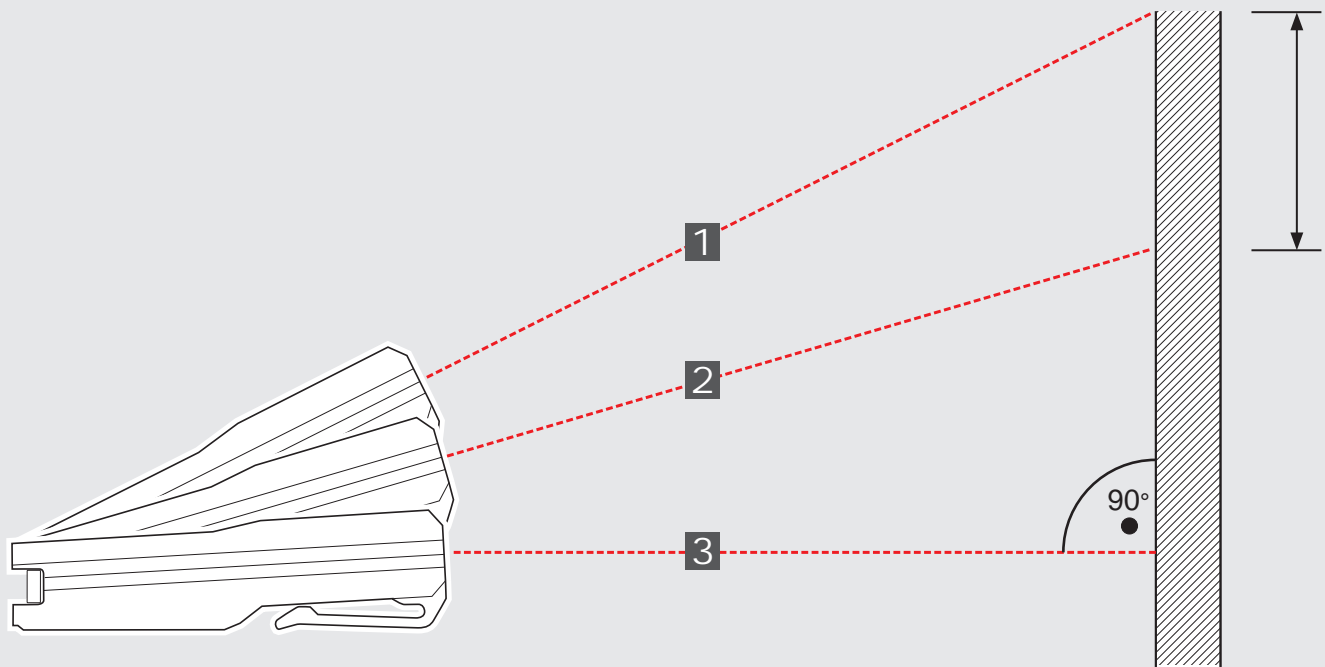
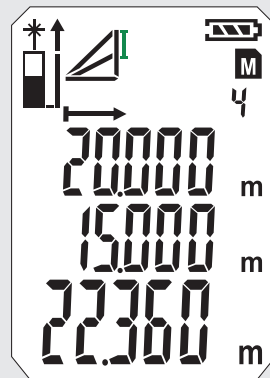
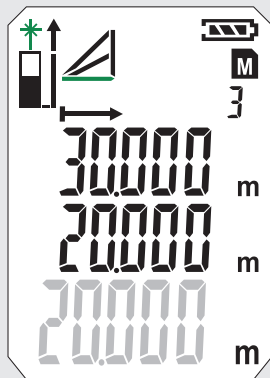
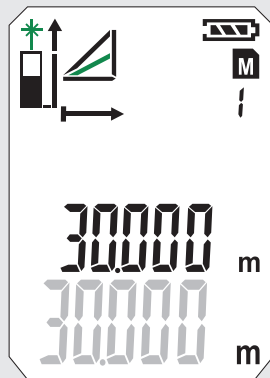
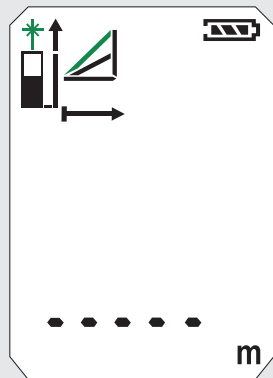

4

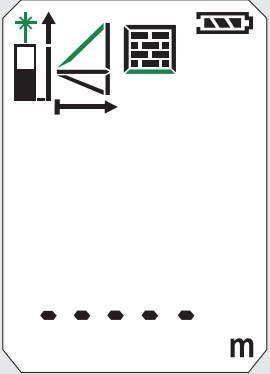
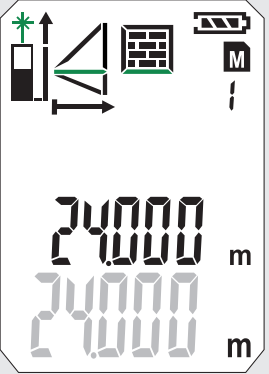
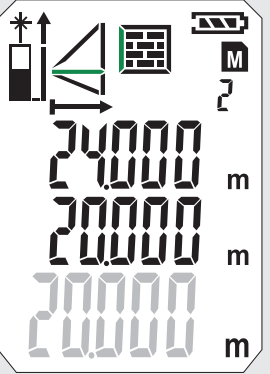
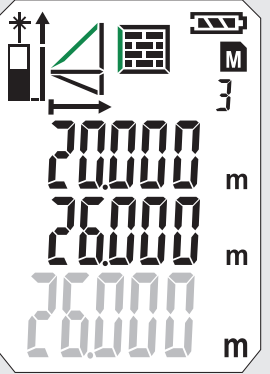
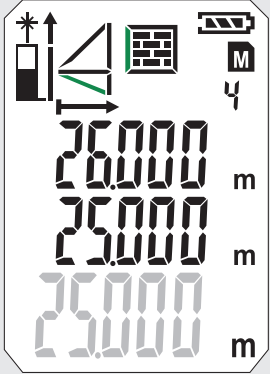

WALL AREA MEASURING (SCENARIO 1)

<p>0</p> 	<p>1</p> 	<p>2</p> 	<p>3</p> 	<p>4</p> 
				

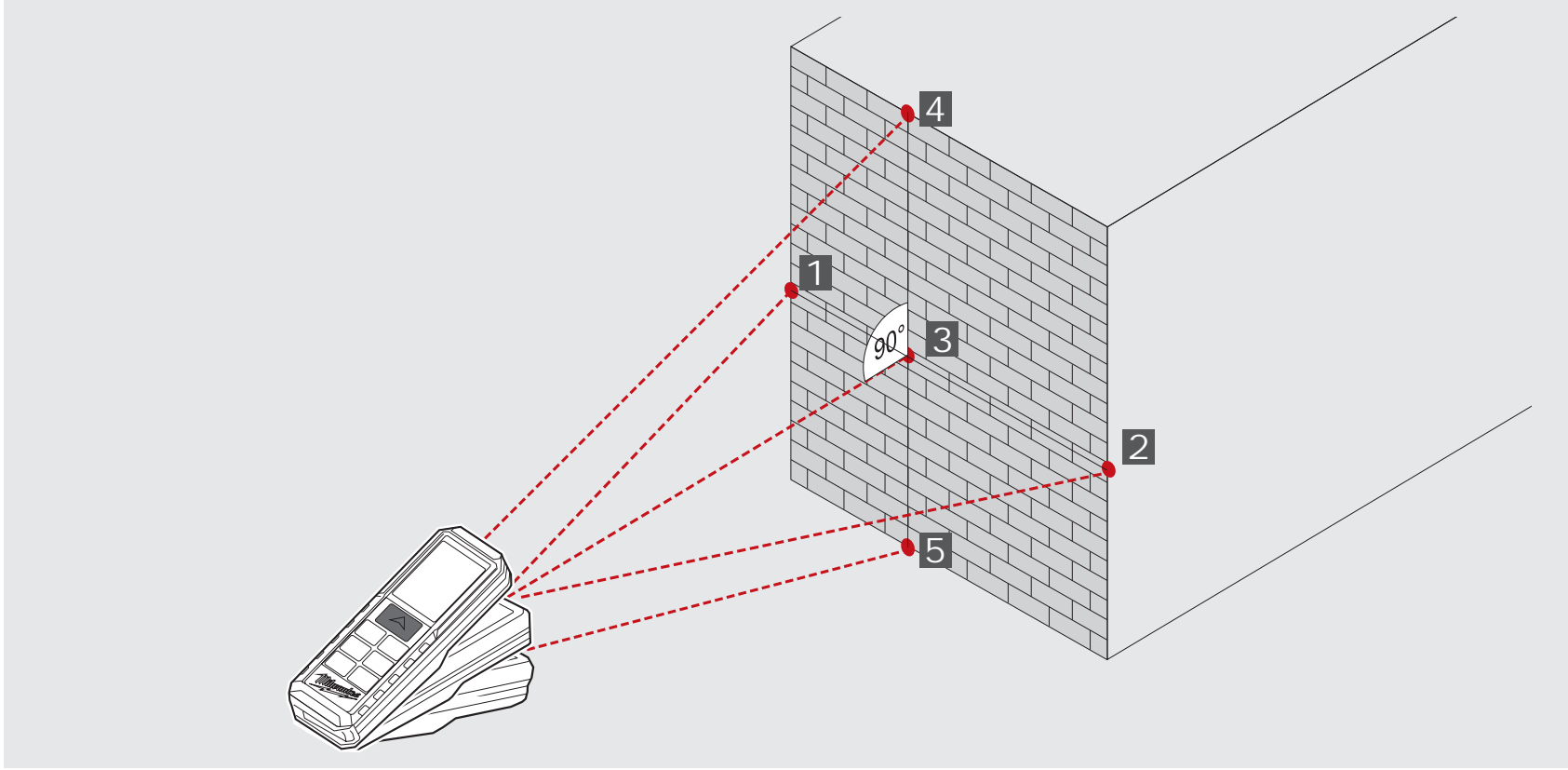

5

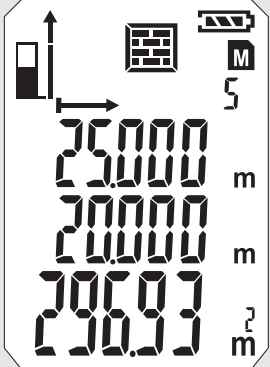
WALL AREA MEASURING (SCENARIO 2)

<p>0</p>	<p>1</p>	<p>2</p>	<p>3</p>	<p>4</p>

5

TIMER

With the timer, the measurement can be start delayed. For example to position a part in the measuring beam.

Push button 

- Icon is displayed.
- Timer can be set between 3 to 15 sec by pressing the button .

Push button 

- The seconds are counted down until the measurement starts.
- At 0, the measurement starts.

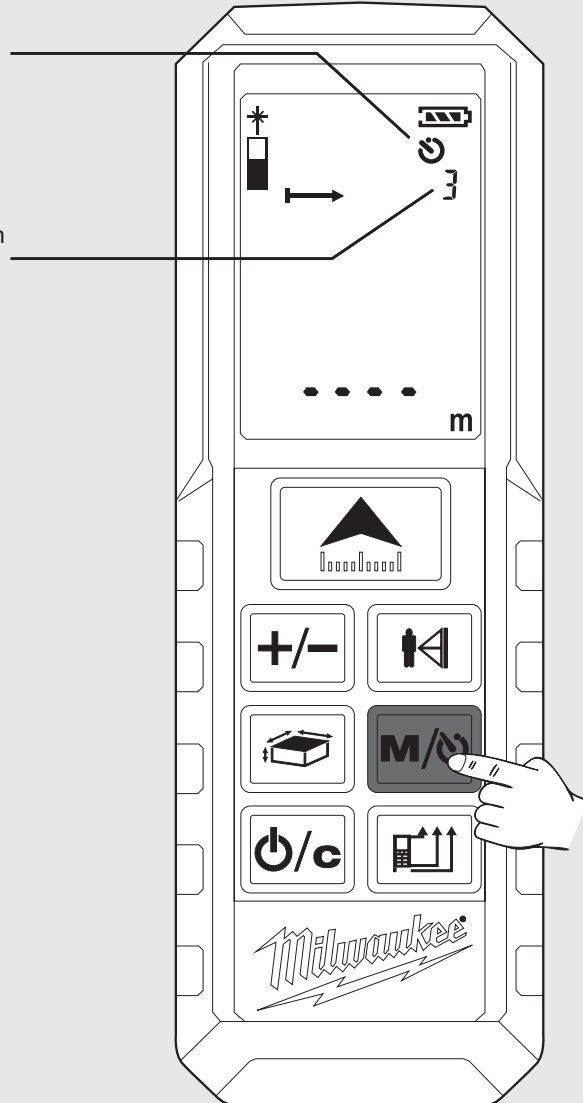

MEMORY

The measured values are stored continuously and automatically in memory.

The stored values can be retrieved by pushing the button .

Push the button  2 sec.

- Icon and memory number appears.
- associated measured parameter is shown.
- Stored value is displayed in the main line.
- read stored values by repeated pushing the button .

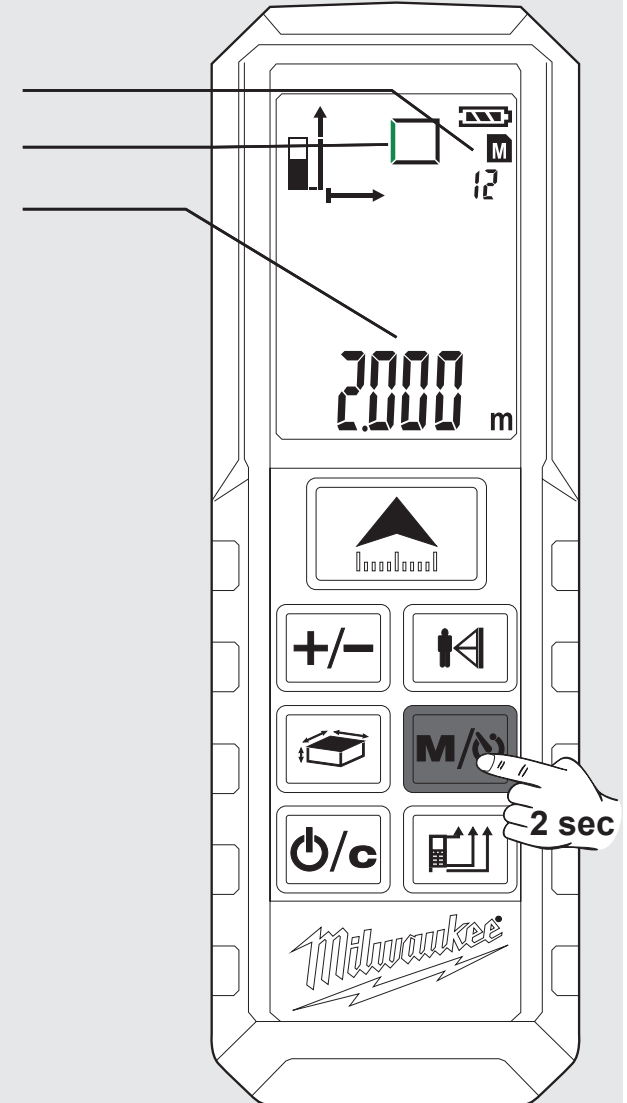

BASIC DESCRIPTION ON EXAMPLE OF AREA MEASURING (1)

1 Turn On

Push Button 
⚠ Attention! Laser on!
 Do not point it at a person!

2 Choose Measuring Reference

Standard after turning on: Bottom
 Push 1x -> Corner Pin
 Push 2x -> Top
 Push 3x -> Bottom

3 Choose Function

After switching on the device is always on single distance measurement
 Push 1x - Area Measurement.

4 Measure length

Level the device and push button 

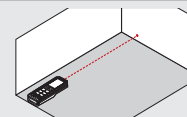

5 Measure width

Level the device and push button 

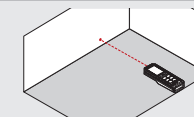

Lasericon flashes (flashing green illustrated).

Icon is displayed.

- Icon appears.
 - Measured parameter flashes (flashing green illustrated)

- Measured value appears briefly in the main line.
 - Measured value jumps by 1 sec in line above.
 - Measured value is stored in memory at consecutive numbers.
 - Second measured parameter flashes.
 - Device ready for measurement of the second value.

- Measured value appears briefly in the base line.
 - Measured value jumps by 1 sec in line above.
 - Measured value is stored in memory at consecutive numbers.
 - Result is displayed in the main line and stored in memory at consecutive numbers.

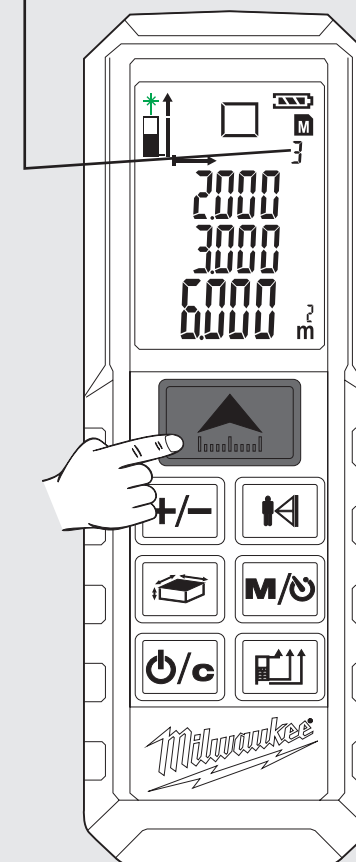
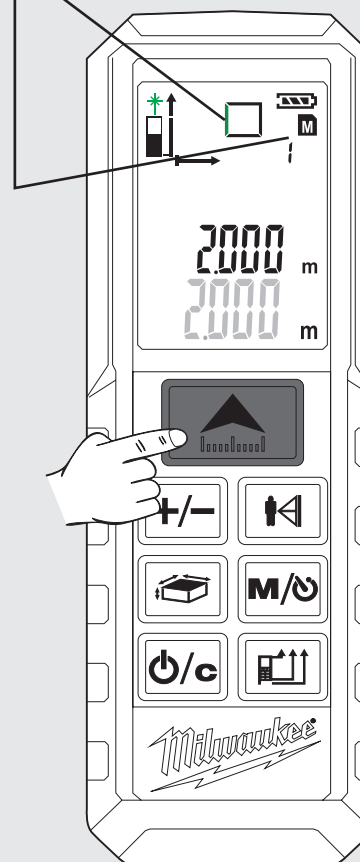
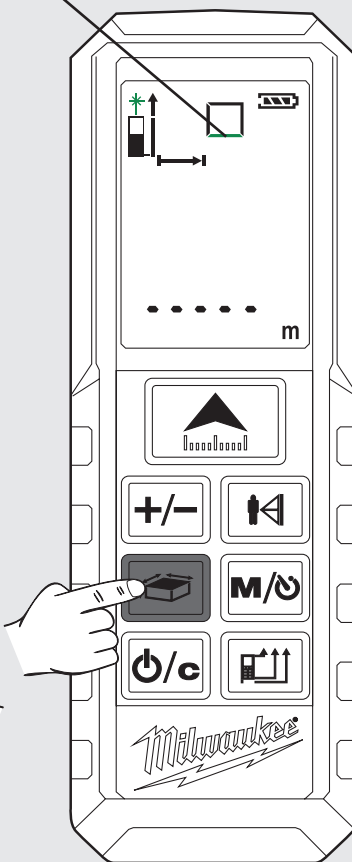
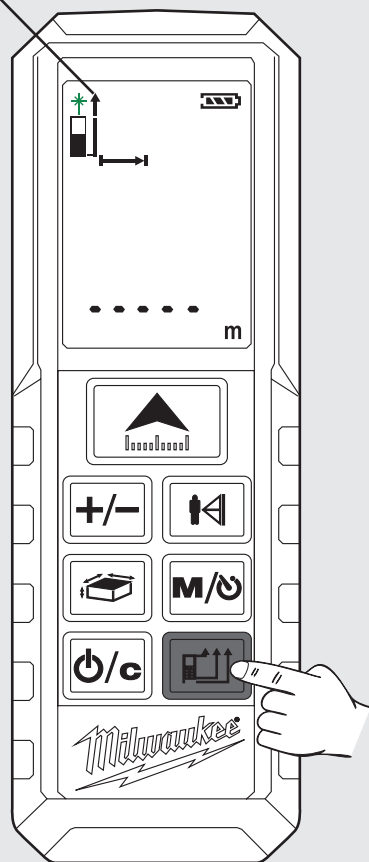
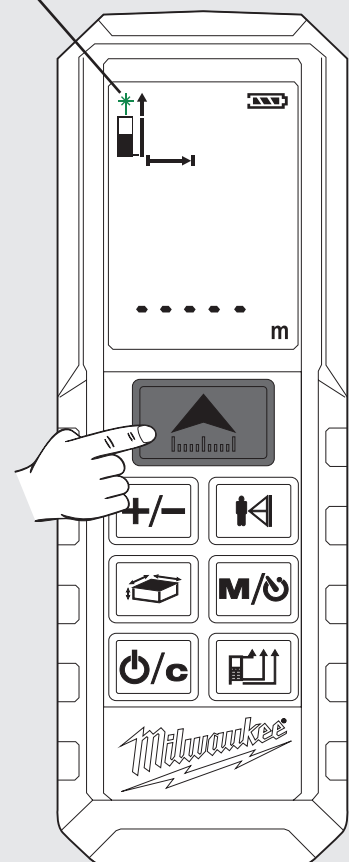

BASIC DESCRIPTION ON EXAMPLE OF AREA MEASURING (2)

6 View stored values

Push button  2 sec.
Push button  repeated

7 Exit memory

Push button .

8 Switch off

Push button  2 sec.
(Memory must be exited before)

- Stored values appears in the main line.

- Associated icon appears and measured parameter flashes (flashing green illustrated)

- Device switches off.

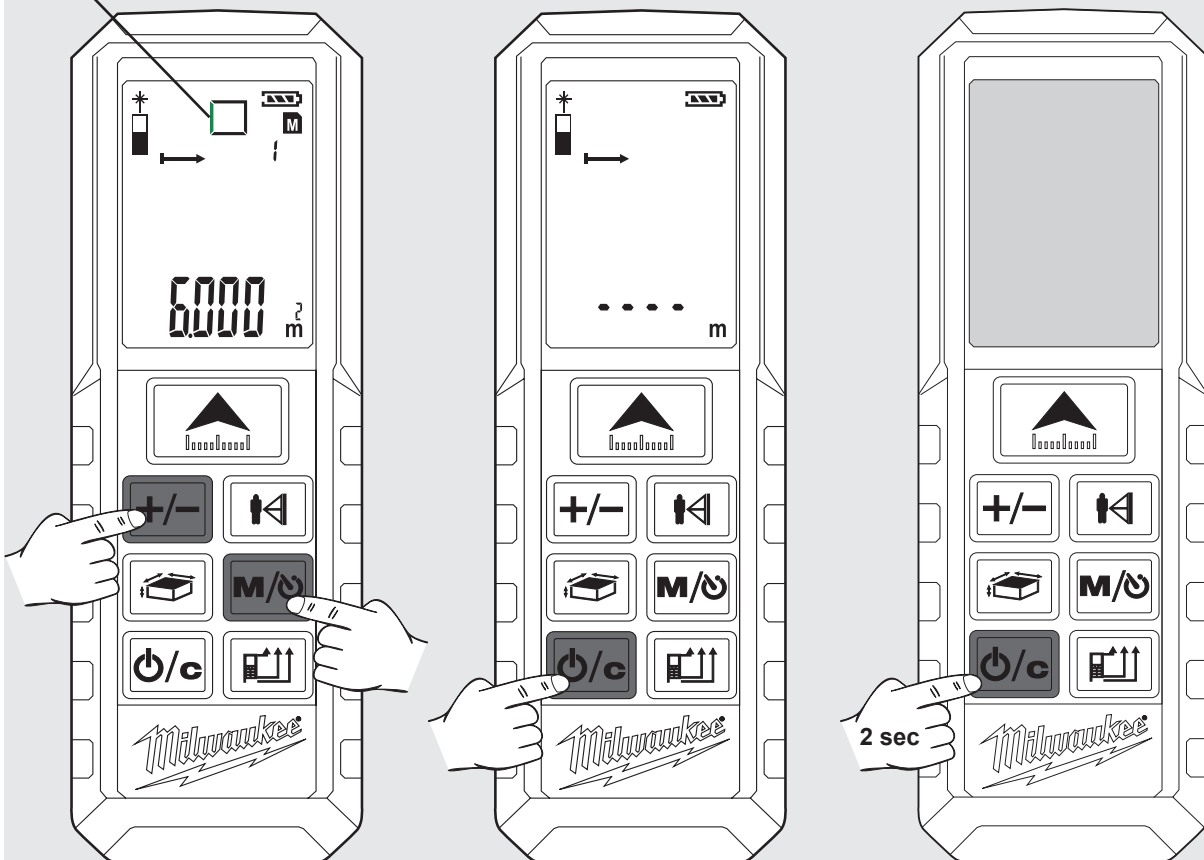

- If no button is pressed, the device switches off automatically after 3 minutes.



INHALT

Wichtige Sicherheitshinweise.....	1
Technische Daten	2
Bestimmungsgemäße Verwendung.....	2
Fehlercode Tabelle	2
Übersicht	3
Batterie wechseln	4
Eckenstift	4
Gürtelhalter.....	4
Funktionstaste, Messebene, Pythagoras,	5
Einfache Längenmessung.....	6
Kontinuierliche Messung / Minimum-Maximum Messung	7
Additions- / Subtraktionsmessung.....	8
Flächenmessung	9
Volumenmessung	10
Indirekte Messung (Pythagoras 1).....	11
Indirekte Messung (Pythagoras 2).....	12
Indirekte Messung (Pythagoras 3).....	13
Wandflächenmessung (Szenario 1)	14
Wandflächenmessung (Szenario 2)	15
Timer	16
Speicher	16
Grundlegende Funktionsweise am Beispiel einer Flächenmessung (1).....	17
Grundlegende Funktionsweise am Beispiel einer Flächenmessung (2).....	18

WICHTIGE SICHERHEITSHINWEISE

  Nehmen Sie das Produkt erst in Gebrauch, wenn Sie die Sicherheitshinweise und die Gebrauchsanweisung auf der beiliegenden CD gelesen haben.

Laserklassifizierung

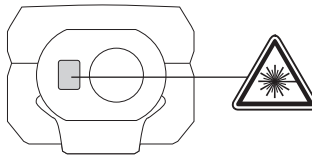

WARNUNG:

Das Produkt entspricht der Laserklasse 2 gemäss EN60825-1:2014.



λ 650 nm P<1 mW

Warnung:

Vermeiden Sie direkten Blickkontakt. Der Laserstrahl kann die Augen verblitzen und zu einer kurzzeitigen Blendung führen.

Nicht in den Laserstrahl blicken und Strahl nicht unnötigerweise auf andere Personen richten.

Keine anderen Personen blenden.

Warnung:

Das Laser-Gerät nicht in der Nähe von Kindern betreiben oder Kindern erlauben, das Laser-Gerät zu benutzen.

Achtung! Eine reflektierende Oberfläche könnte den Laserstrahl zurück an den Bediener oder andere Personen reflektieren.

Halten Sie einen entsprechenden Sicherheitsabstand zu den beweglichen Teilen.

Regelmässige Kontrollmessungen durchführen, insbesondere vor, während und nach wichtigen Messaufgaben.

Vorsicht vor fehlerhaften Messungen beim Verwenden eines defekten Produkts, nach einem Sturz oder sonstigen unzulässigen Anwendungen bzw. Veränderungen am Produkt.

Warnung: Die Verwendung von Steuerelementen, Einstellungen oder die Durchführung von anderen als den im Handbuch festgelegten Verfahren kann zu gefährlicher Strahlenbelastung führen.

Das Lasermessgerät hat einen begrenzten Einsatzbereich. (Siehe Abschnitt "Technische Daten"). Versuche, außerhalb des maximalen und minimalen Bereichs zu messen, verursachen Ungenauigkeiten. Der Einsatz bei widrigen Bedingungen, wie zu heiß, zu kalt, sehr hellem Sonnenlicht, Regen, Schnee, Nebel oder anderen sichteinschränkenden Bedingungen, kann zu ungenauen Messungen führen.

Wenn das Lasermessgerät von einer warmen Umgebung in eine kalte Umgebung gebracht wird (oder umgekehrt), warten Sie, bis sich das Gerät der neuen Umgebungstemperatur angepasst hat.

Das Lasermessgerät immer innerhalb von Räumen aufbewahren, das Gerät vor Erschütterung, Vibrationen oder extremen Temperaturen schützen.

Das Lasermessgerät vor Staub, Nässe und hoher Luftfeuchtigkeit schützen. Dies kann innere Bauteile zerstören oder die Genauigkeit beeinflussen.



Verwenden Sie keine aggressiven Reinigungsmittel oder Lösungsmittel. Nur mit einem sauberen, weichen Tuch reinigen.

Vermeiden Sie starke Schläge auf das oder den Fall des Lasermessgeräts. Die Genauigkeit des Gerätes sollte überprüft werden, wenn es heruntergefallen ist oder anderen mechanischen Belastungen ausgesetzt war.

Erforderlichen Reparaturen an diesem Laser-Gerät dürfen nur von autorisiertem Fachpersonal durchgeführt werden.

Das Produkt darf nicht in einer explosionsgefährdeten oder aggressiven Umgebung eingesetzt werden.

Zum Aufladen der Akkus nur vom Hersteller empfohlene Ladegeräte verwenden.

 Altbatterien, Elektro- und Elektronik-Altgeräte dürfen nicht zusammen mit dem Hausmüll entsorgt werden.
 Altbatterien, Elektro- und Elektronik-Altgeräte sind getrennt zu sammeln und zu entsorgen.

Entfernen Sie Altbatterien, Altkumulatoren und Leuchtmittel vor dem Entsorgen aus den Geräten.

Erkundigen Sie sich bei den örtlichen Behörden oder bei Ihrem Fachhändler nach Recyclinghöfen und Sammelstellen.

Je nach den örtlichen Bestimmungen können Einzelhändler verpflichtet sein, Altbatterien, Elektro- und Elektronik-Altgeräte kostenlos zurückzunehmen.

Tragen Sie durch Wiederverwendung und Recycling Ihrer Altbatterien, Elektro- und Elektronik-Altgeräte dazu bei, den Bedarf an Rohmaterialien zu verringern.

Altbatterien (vor allem Lithium-Ionen-Batterien), Elektro- und Elektronik-Altgeräte enthalten wertvolle, wiederverwertbare Materialien, die bei nicht umweltgerechter Entsorgung negative Auswirkungen auf die Umwelt und Ihre Gesundheit haben können.

Löschen Sie vor der Entsorgung möglicherweise auf Ihrem Altgerät vorhandene personenbezogene Daten.

 Europäisches Konformitätszeichen

 Britisches Konformitätszeichen

 Ukrainisches Konformitätszeichen

 Euroasiatisches Konformitätszeichen

TECHNISCHE DATEN

Schutzklasse	IP54 (staub- und spritzwassergeschützt)
Optik	14 mm
Brennpunkt	35 mm
Messbereich max.	50 Meter (Toleranz: 55 m)
Messbereich min.	0,05 Meter
Absolute Genauigkeit @ < 10m	± 1,5 mm (Max)
Wiederholgenauigkeit @ < 10m	± 1,5 mm (typisch max. 2σ)
Wiederholgenauigkeit @ > 10m	Anstieg ± 0,25 mm / Meter (typisch max. 2σ)
Messzeit	0,5 s
Display Typ	LCD (22,7 mm x 31 mm)
Stromversorgung	AAA 2x (Alkaline-Batterie)
Batterielebensdauer	10000 (Einzelmessung)
Laser Ausgangsleistung	0,6 mW ~ 0,95 mW (Class 2, 650nm)
Laserpunktgröße	25 x 30 mm @ 16 m (Max)
Laserklasse	2
Lasertyp	650 nm, < 1 mW
Laserstrahl Vertikalwinkel	+1 Grad
Laserstrahl Horizontalwinkel	±1 Grad
Automatische Geräteabschaltung	180 Sekunden
Automatische Laserabschaltung	30 Sekunden
Arbeitstemperaturbereich	-10°C to +50°C
Lagertemperaturbereich	-25°C to +70°C
Gewicht ohne Batterie	80 g

BESTIMMUNGSGEMÄSSE VERWENDUNG

Das Lasermessgerät ist geeignet zum Messen von Distanzen und Neigungen.
Dieses Gerät darf nur wie angegeben bestimmungsgemäß verwendet werden.

FEHLERCODE TABELLE

Code	Beschreibung	Lösung
Err01	Außerhalb des Messbereiches	Messung im vorgesehenen Bereich durchführen.
Err02	Reflektiertes Signal ist zu schwach	Eine bessere Oberfläche wählen.
Err03	Außerhalb des Anzeigebereiches (max. Wert: 99.999) z.B. ist das Ergebnis von Fläche oder Volumen außerhalb des Anzeigebereiches	Prüfen, ob die Werte und Schritte korrekt sind.
Err04	Fehler in der Pythagorasberechnung	Prüfen, ob die Werte und Schritte korrekt sind.
Err05	Battery schwach	Neue Batterien einsetzen.
Err06	Außerhalb des Arbeitstemperaturbereichs	Messung im vorgegebenen Arbeitstemperaturbereich durchführen.
Err07	Umgebungslicht zu hell	Zielbereich abdunkeln.

Pythagoras
Höhendifferenz

Messebene

Längenmessung

Minimum / Maximum für kontinuierliche Messung

Addition / Subtraktion

EIN / MESSEN

- ▶ Ein
- ▶ Messen
- ▶ Kontinuierliche Messung (2 sek drücken)
Min. / Max. Funktion

ADDITION / SUBSTRAKTION

- ▶ Wert addieren
- ▶ Wert subtrahieren

FLÄCHE / VOLUMEN

- ▶ Fläche (1x drücken)
- ▶ Volumen (2x drücken)
- ▶ Indirekte Flächenmessung (3x / 4x drücken)

EINSCHALTEN

- ▶ Ein
- ▶ Aus (2 sek drücken)
- ▶ Zurücksetzen

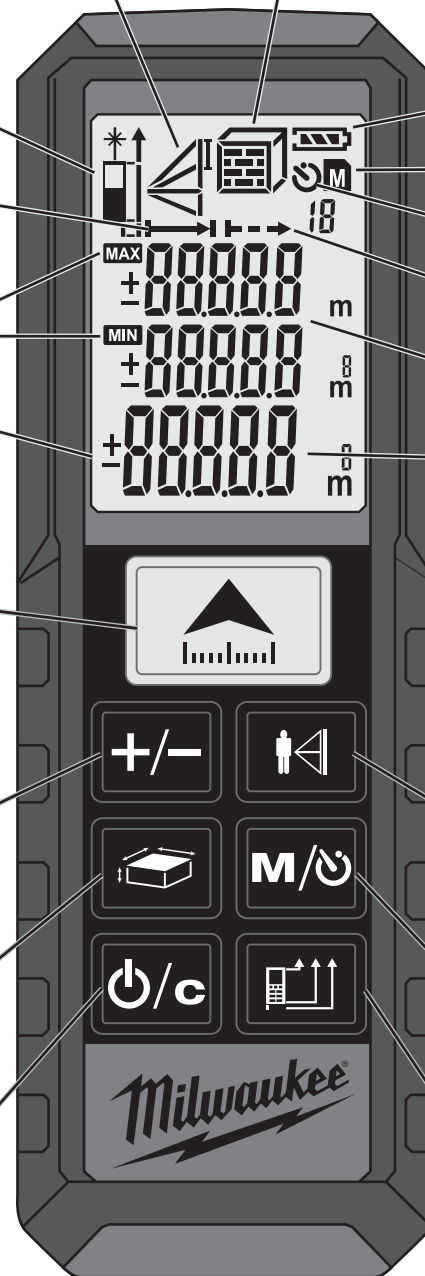

Fläche / Volumen
Indirekte Flächenmessung

Batteriestatus

Speicher

Timer

Kontinuierliche Messung

Zwischenwerte

Gesamtwert

PYTHAGORAS

- ▶ Pythagoras 1 (1x drücken)
- ▶ Pythagoras 2 (2x drücken)
- ▶ Pythagoras 3 (3x drücken)

SPEICHER

- ▶ Timer 3-15 sek (1x drücken)
- ▶ Speicher 1-20 (1x 2 sek drücken)
- ▶ Speicherwerte abrufen (wiederholt drücken)

MESSEBENE WECHSELN

- ▶ Vorn
- ▶ Hinten
- ▶ Eckenstift

BATTERIE WECHSELN

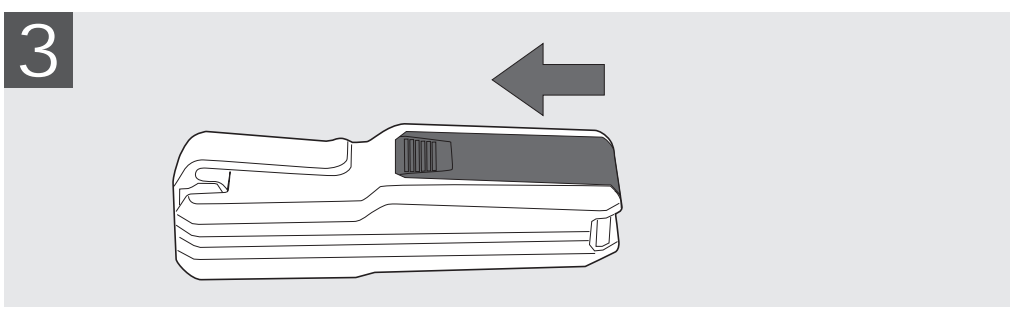
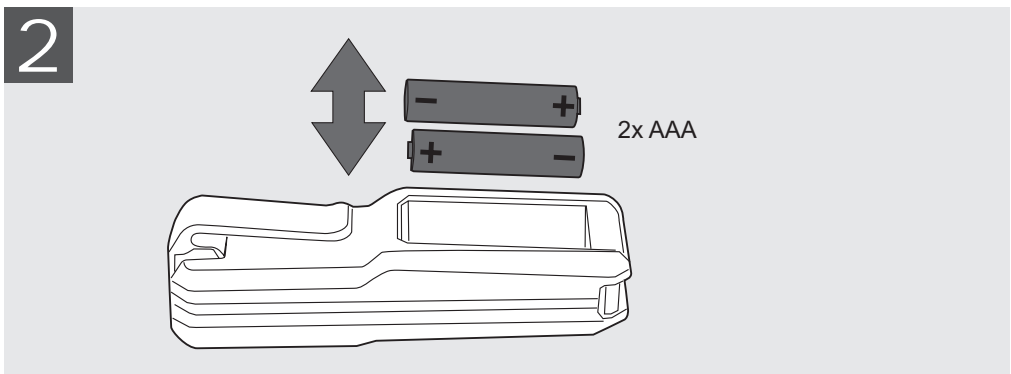
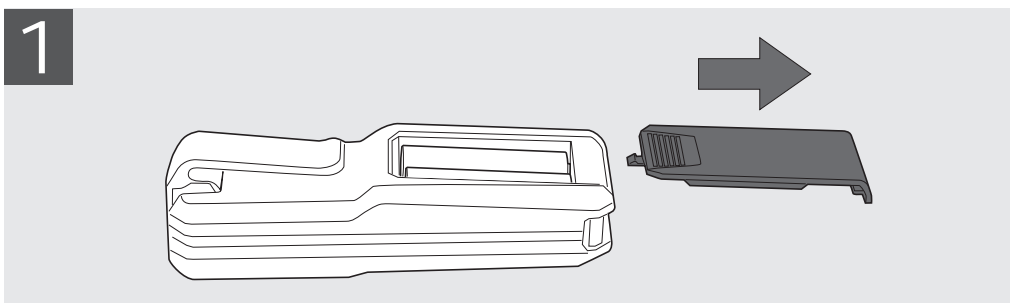
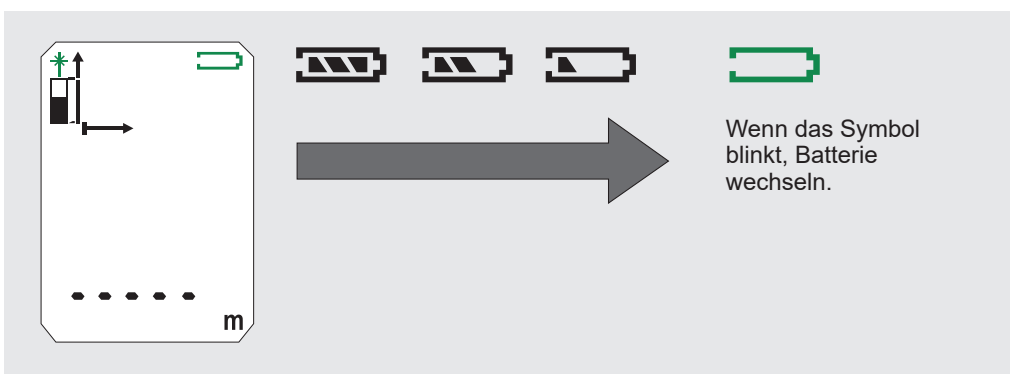

ECKENSTIFT

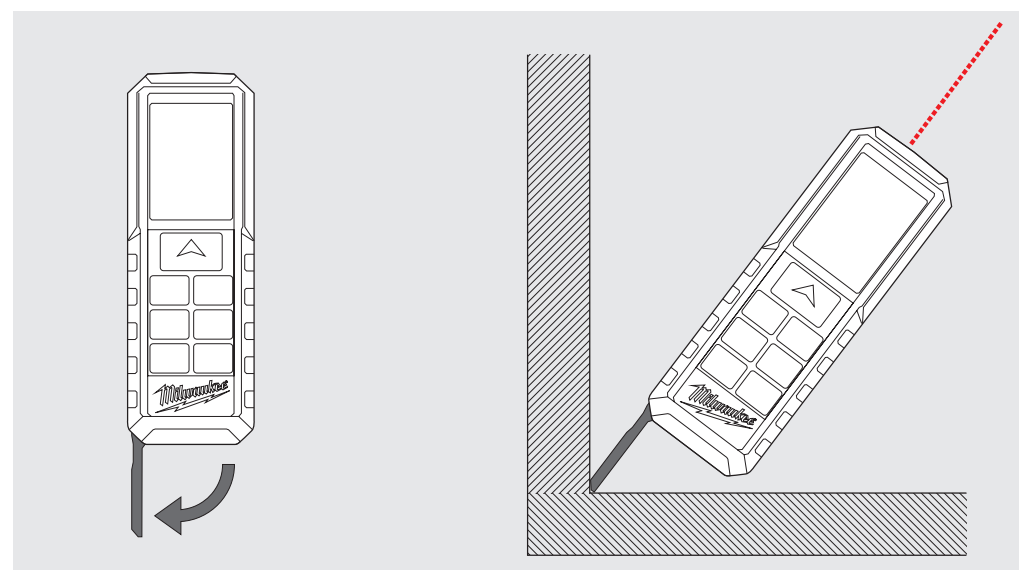

GÜRTELHALTER

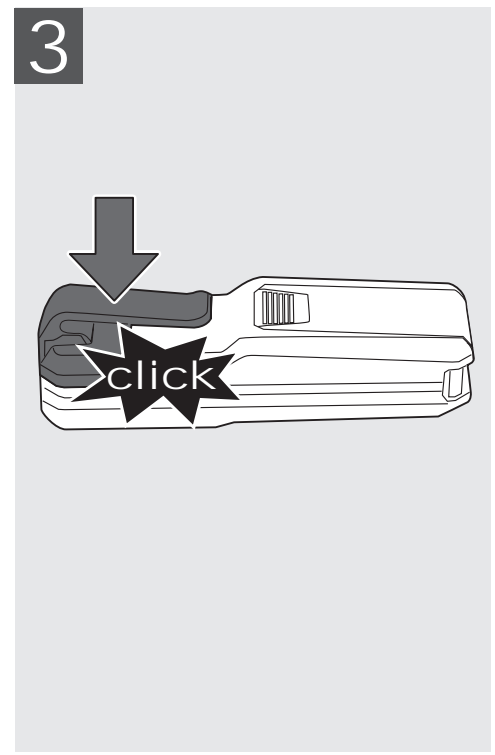
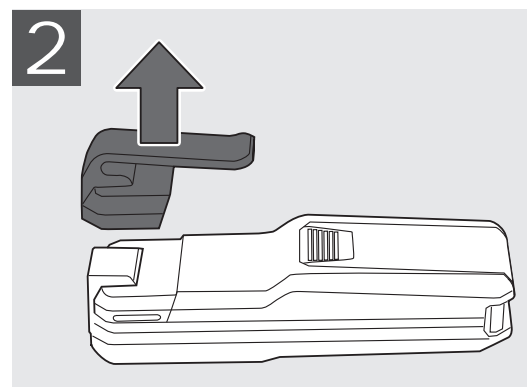
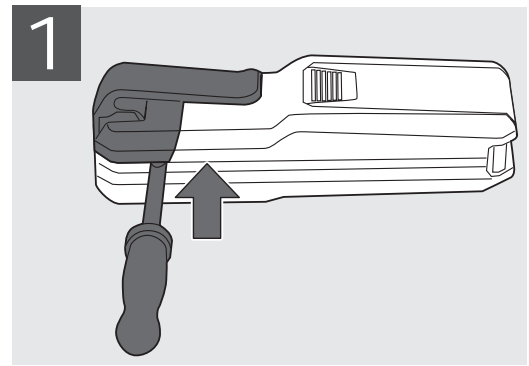

FUNKTIONSTASTE, MESSEBENE, PYTHAGORAS,

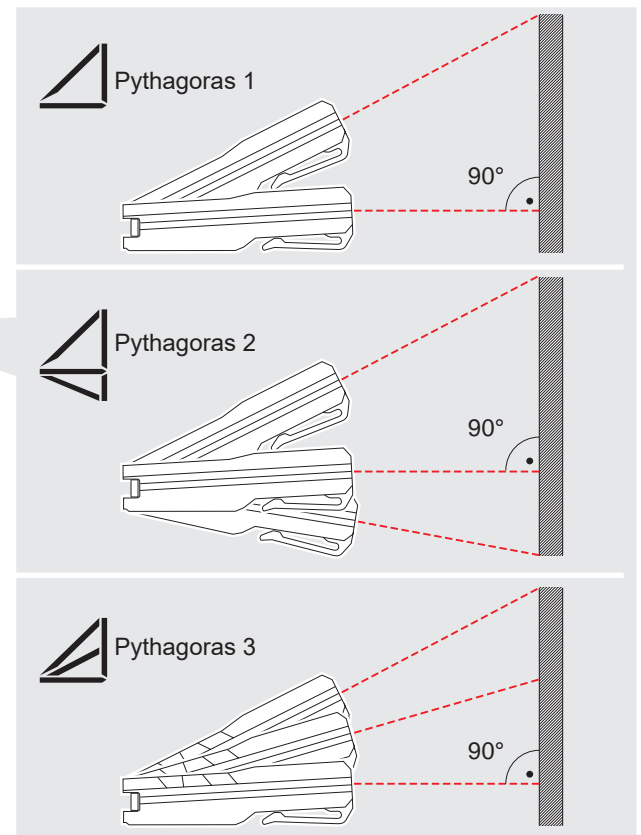
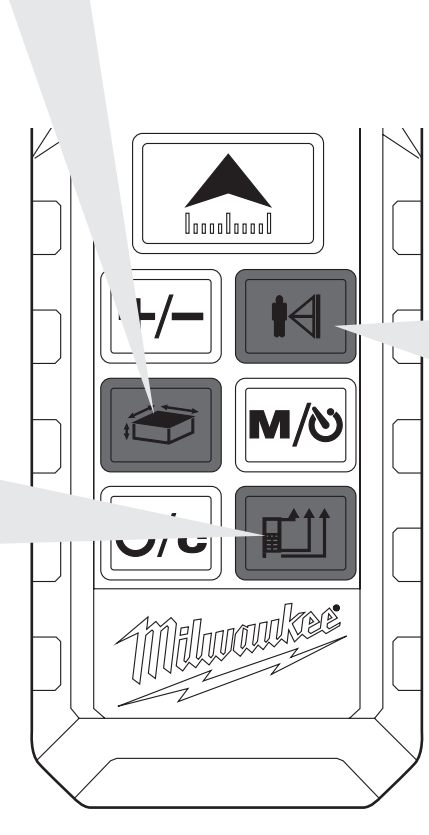
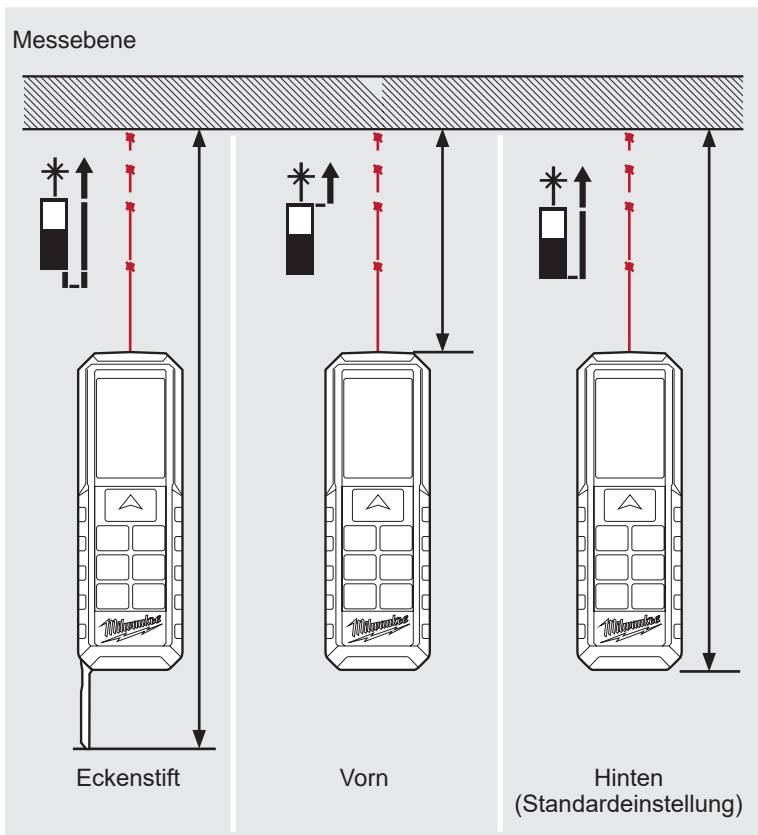
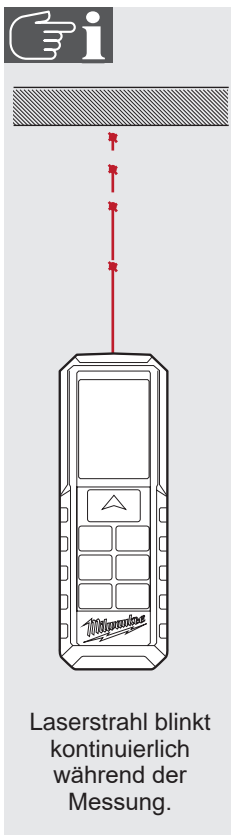
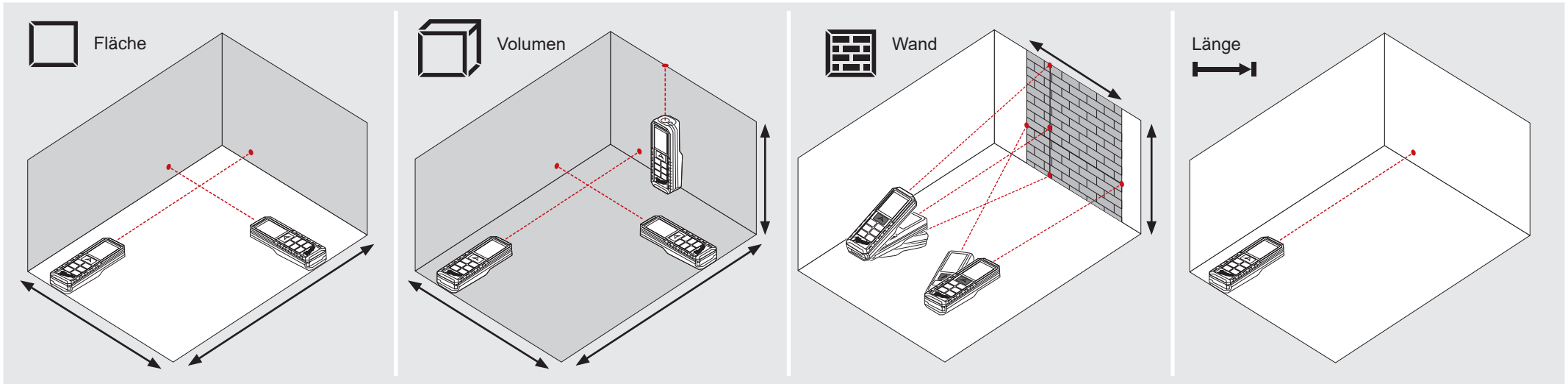

EINFACHE LÄNGENMESSUNG

0

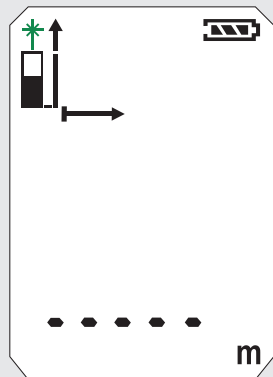

1

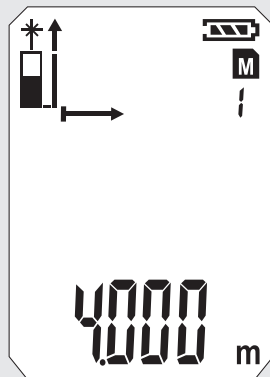

2

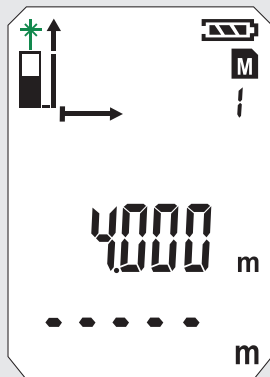

3

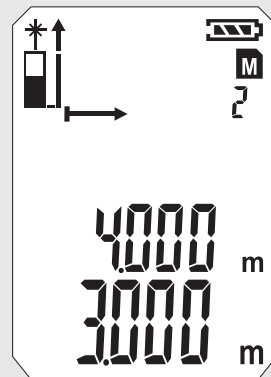

4

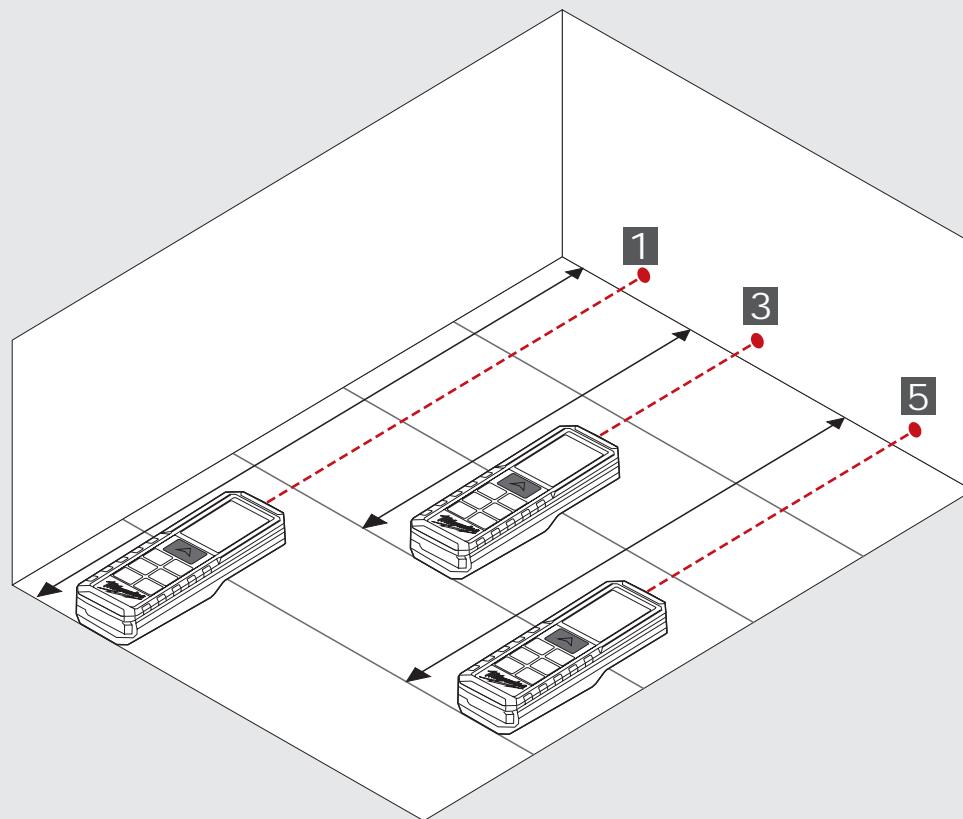
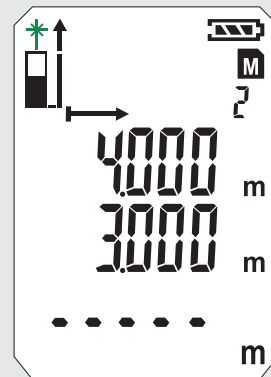

5

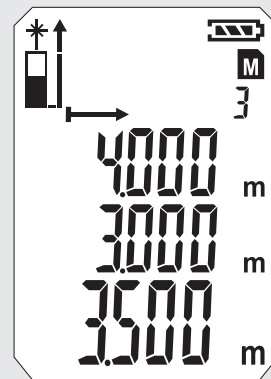

KONTINUIERLICHE MESSUNG / MINIMUM-MAXIMUM MESSUNG

0

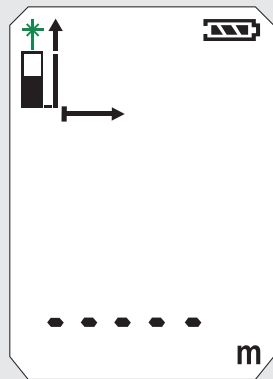

1

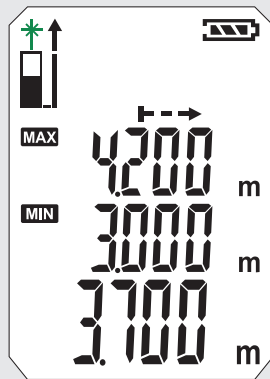

2

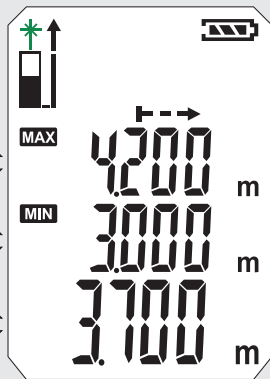

3



Stop
MIN / MAX

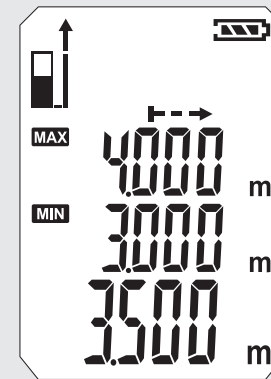

4

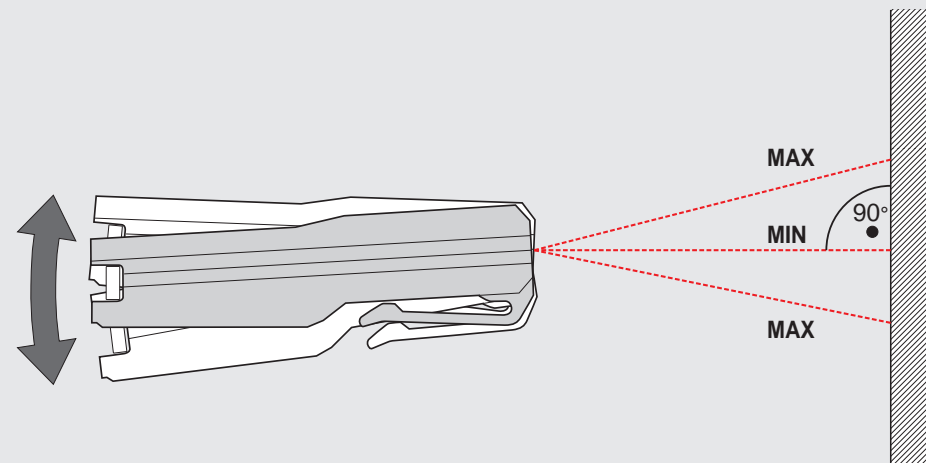
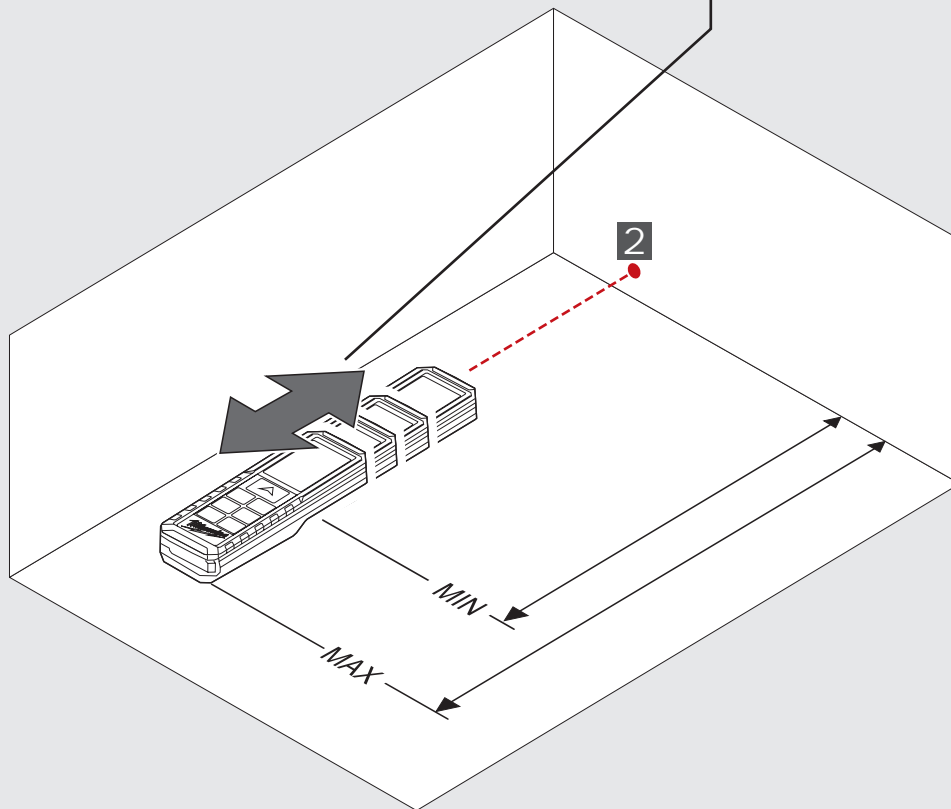
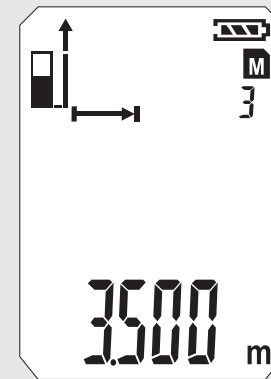

0

1

2

3

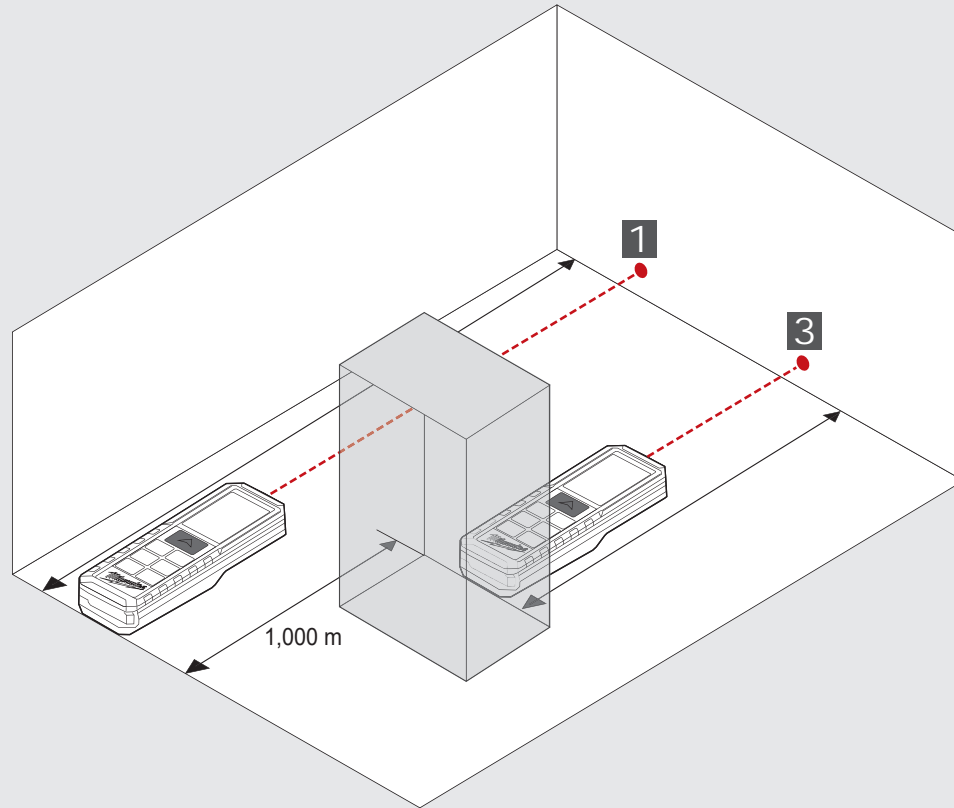
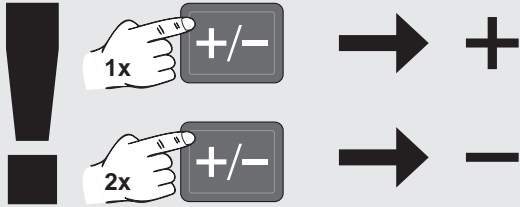
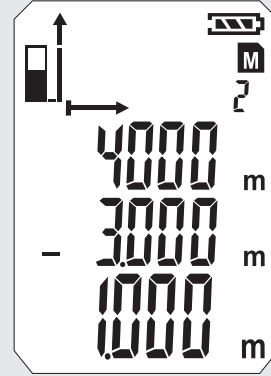
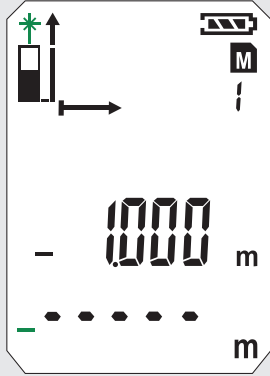
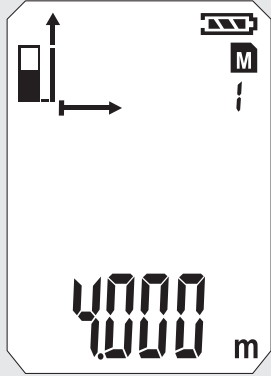
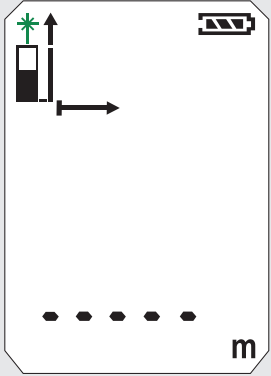
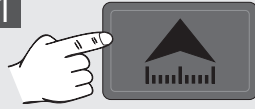

0



1



2

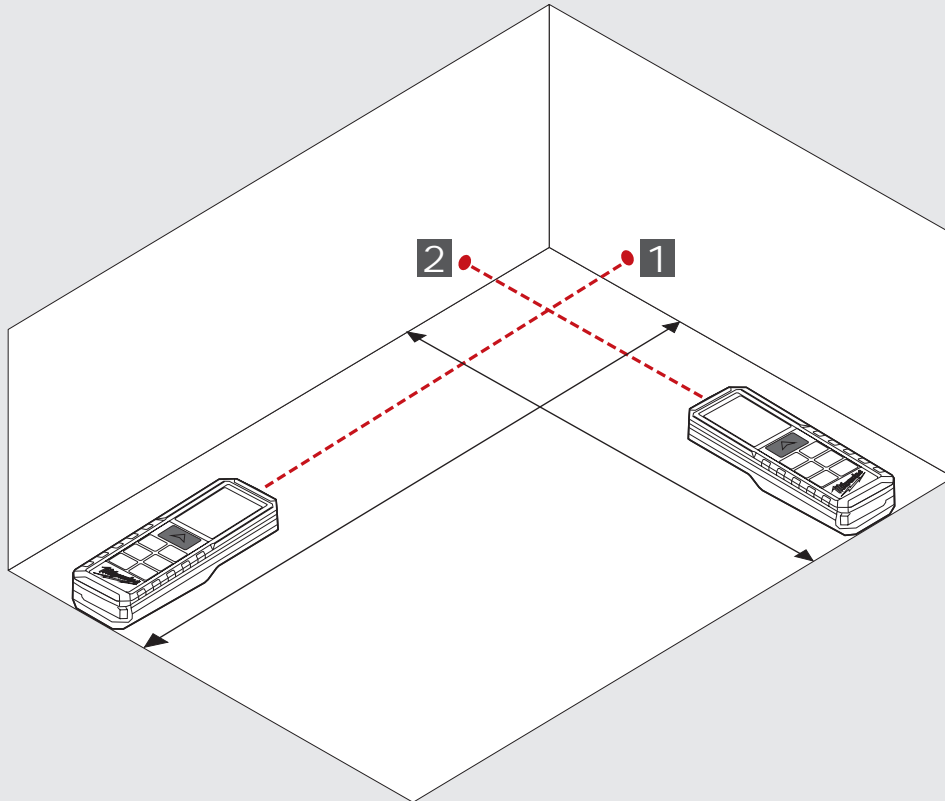
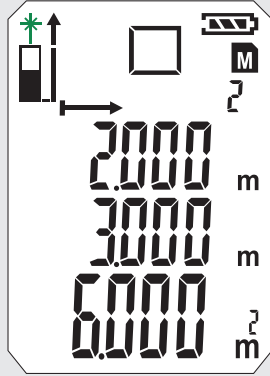
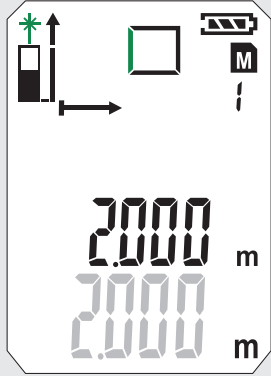
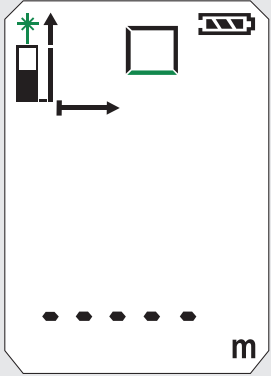

VOLUMENMESSUNG

0



1



2



3

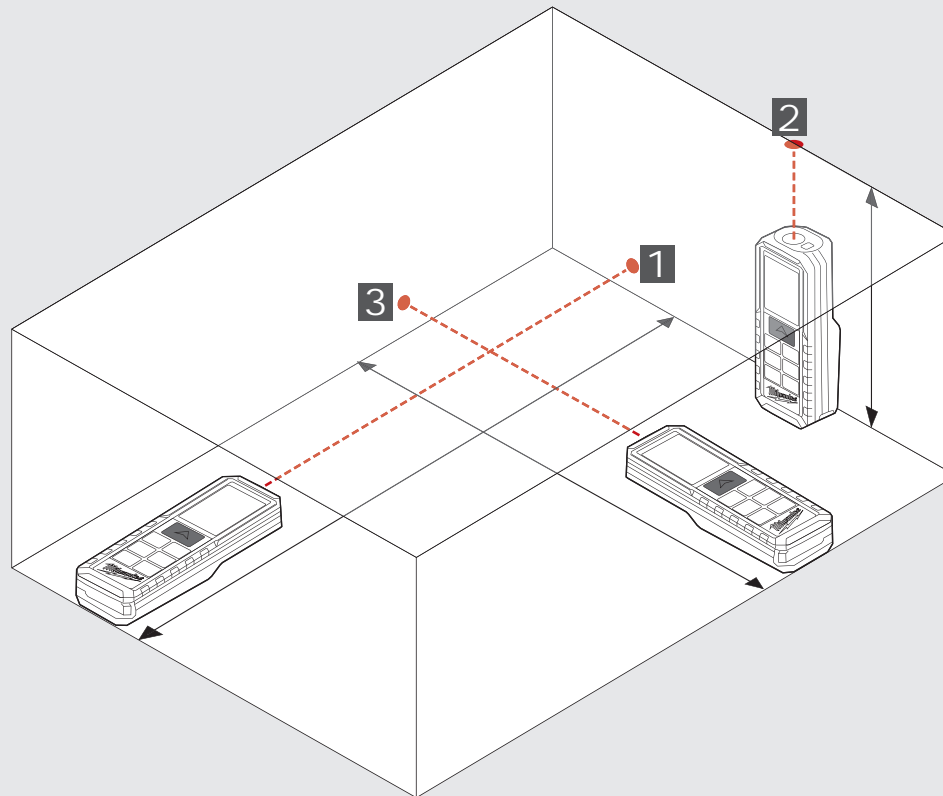
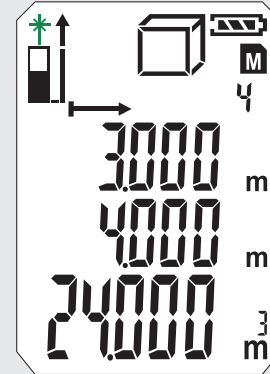
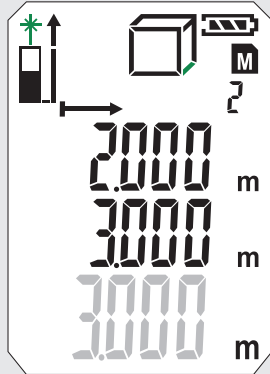
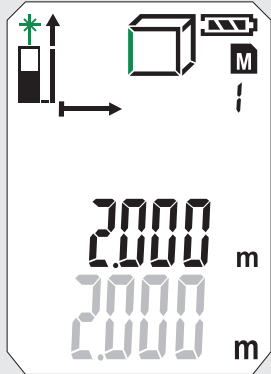
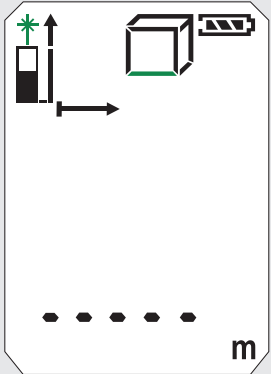
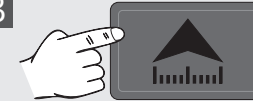

INDIREKTE MESSUNG (PYTHAGORAS 1)

0



1 x

1



2

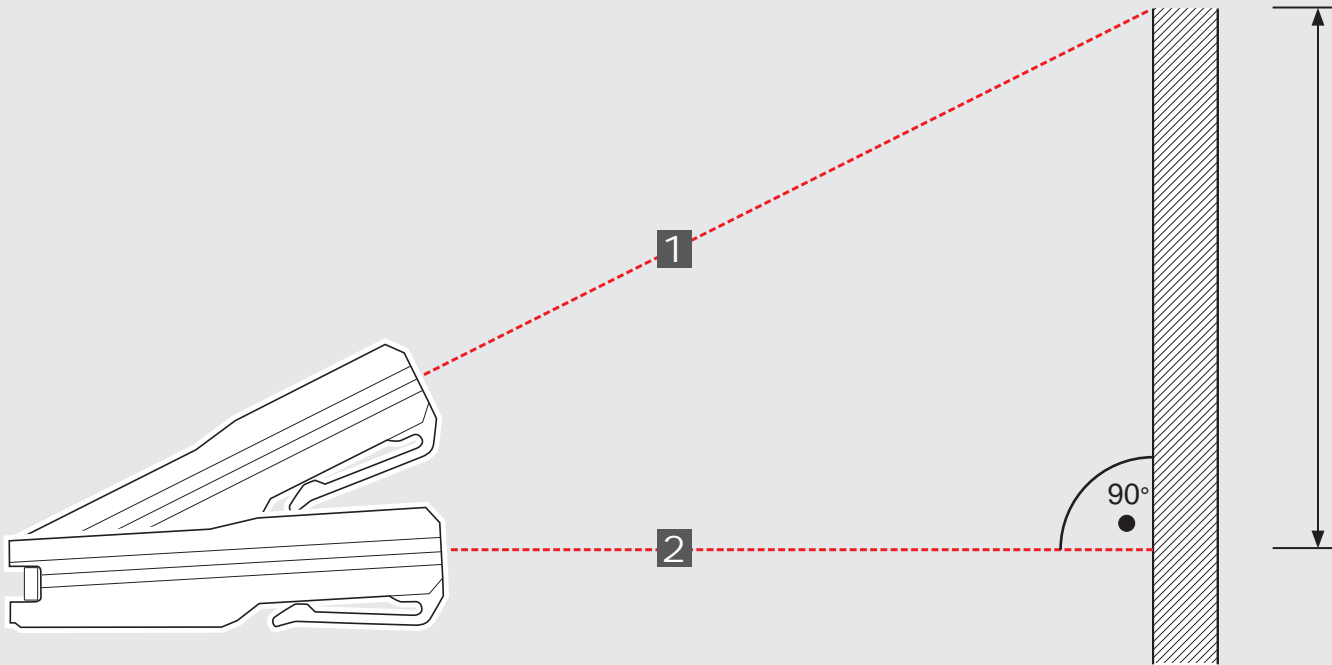
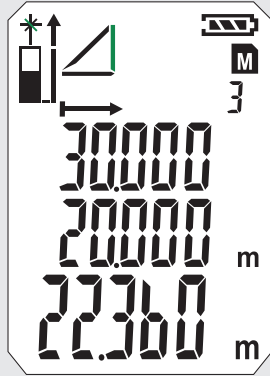
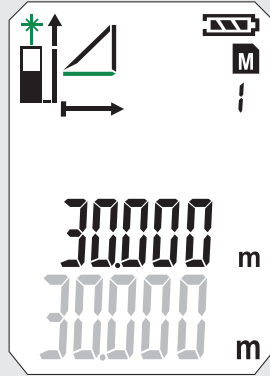
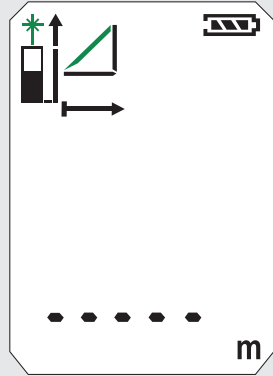

INDIREKTE MESSUNG (PYTHAGORAS 2)

0



1



2



3

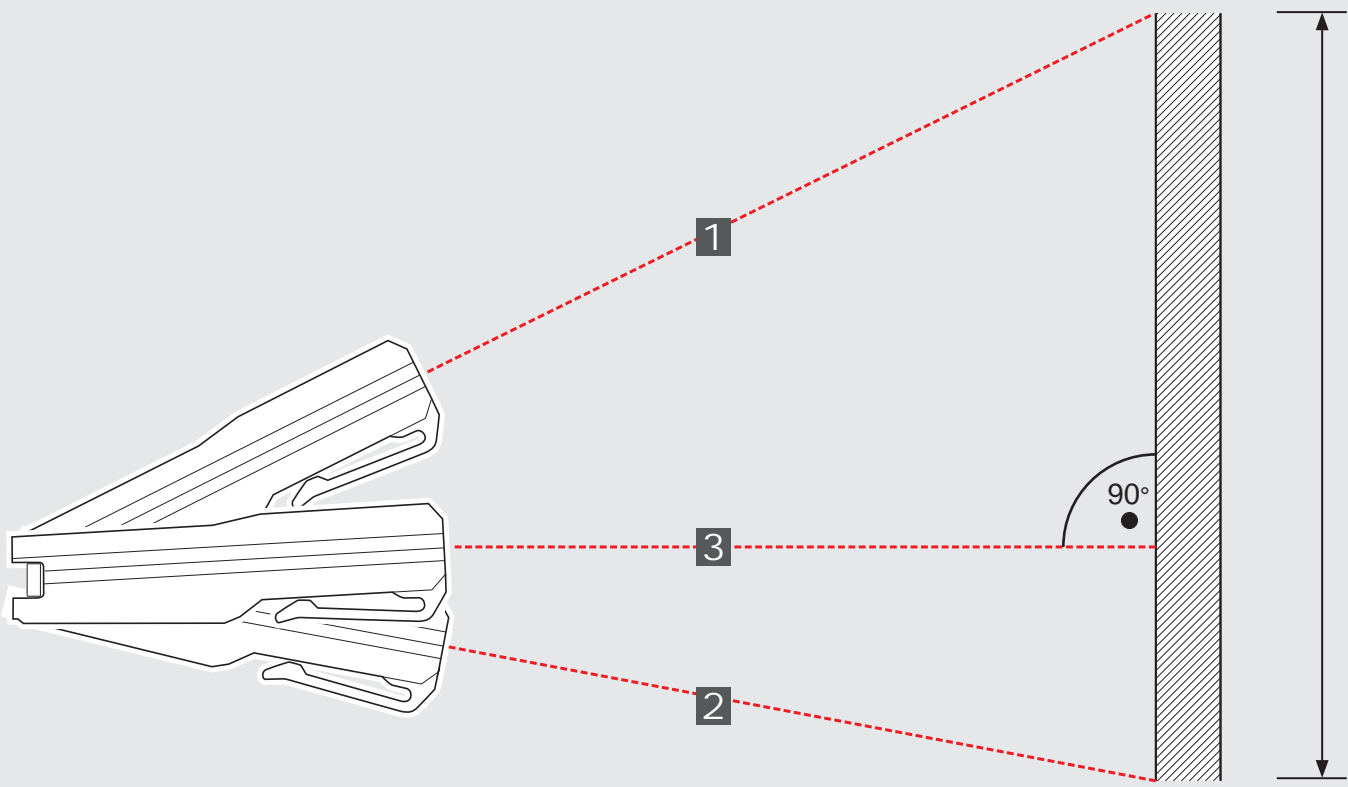
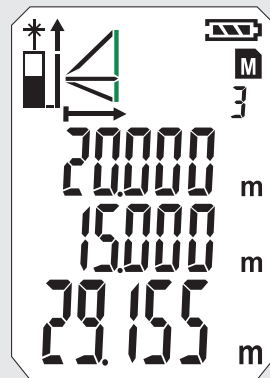
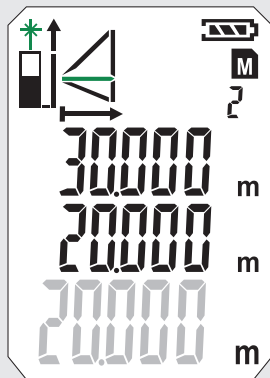
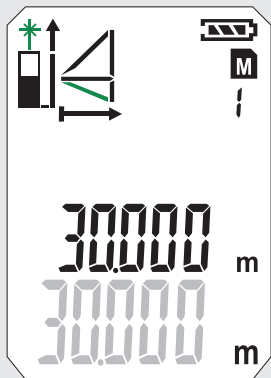
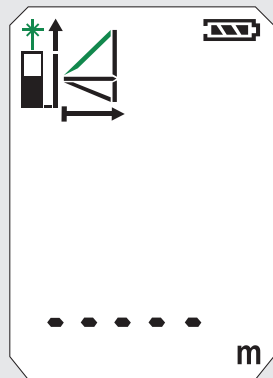

INDIREKTE MESSUNG (PYTHAGORAS 3)

1



2







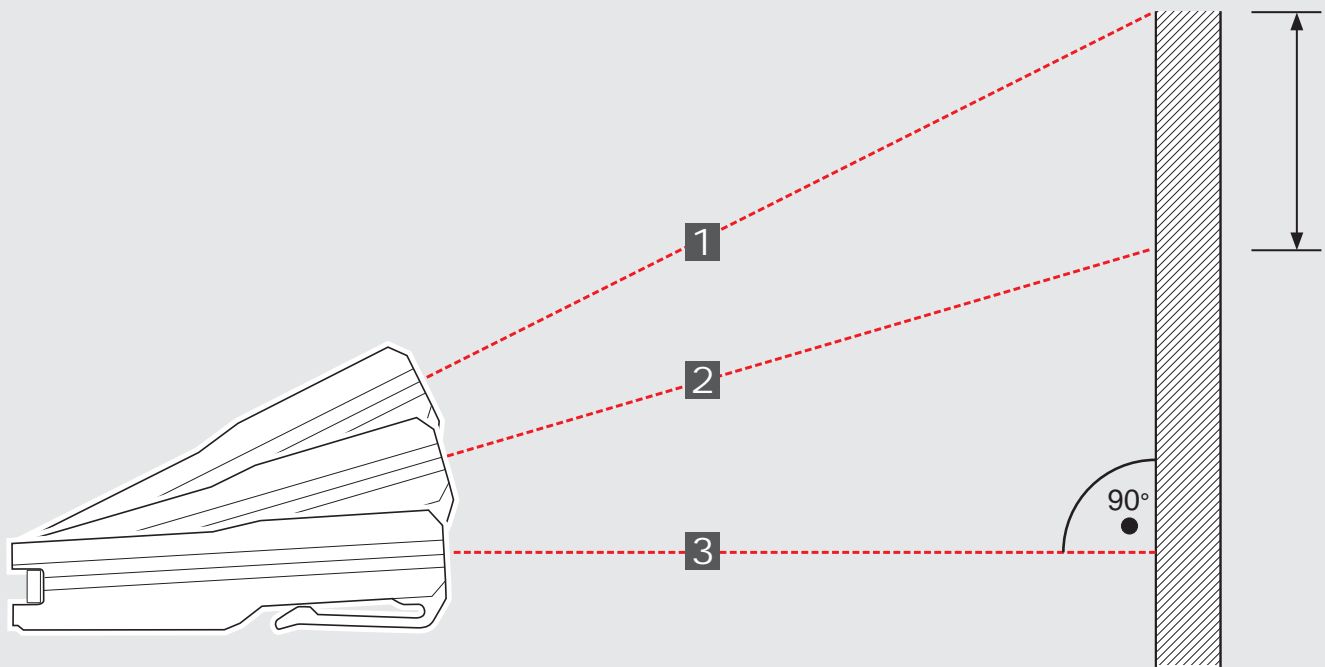
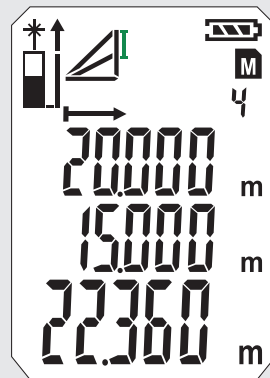
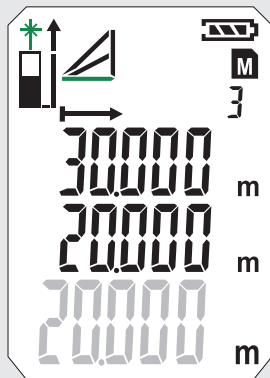
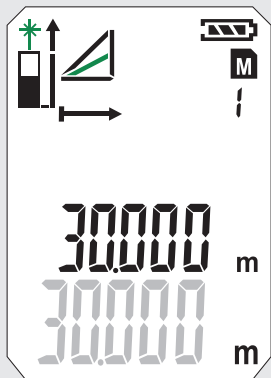
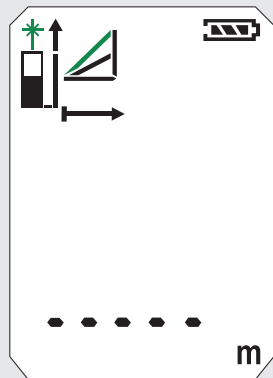

3



4



WANDFLÄCHENMESSUNG (SZENARIO 1)

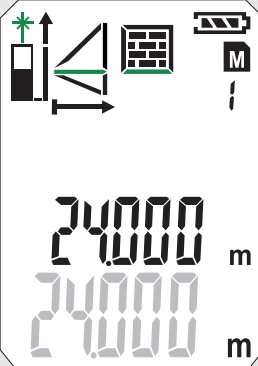
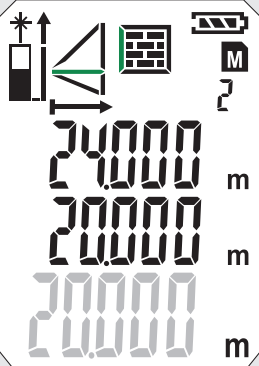
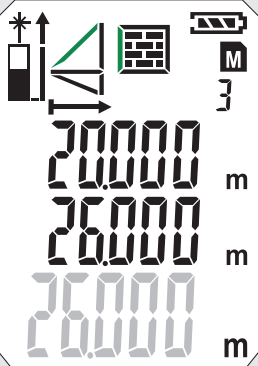
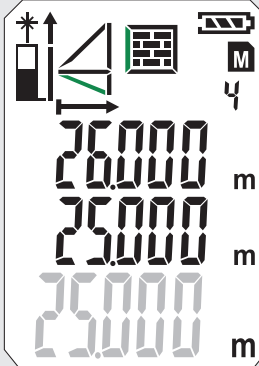

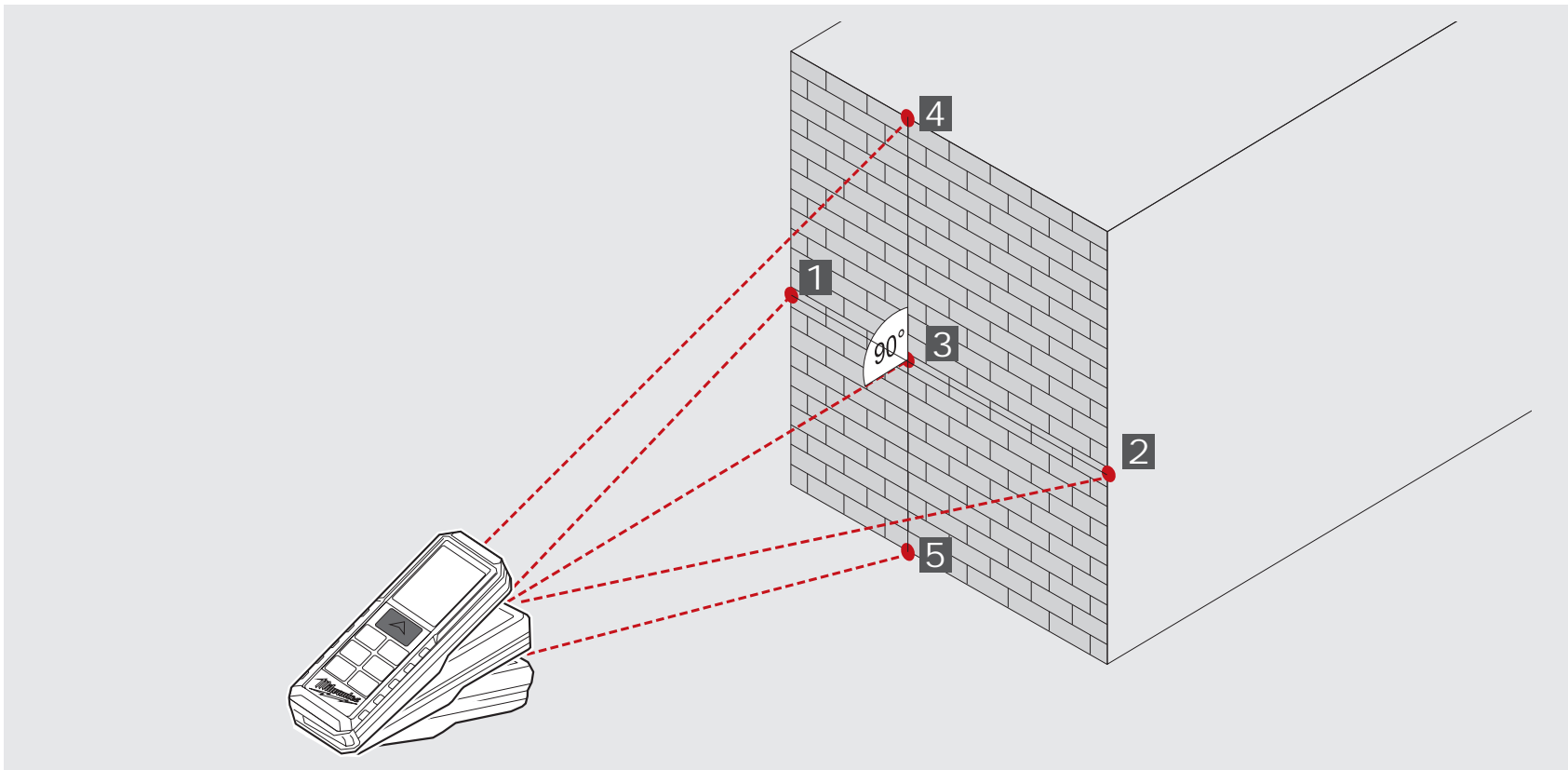

<p>0</p> 	<p>1</p> 	<p>2</p> 	<p>3</p> 	<p>4</p> 
				

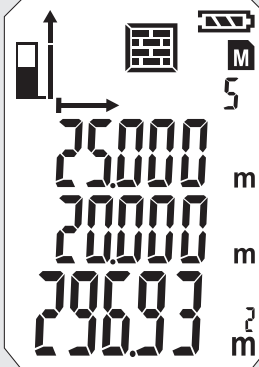

5



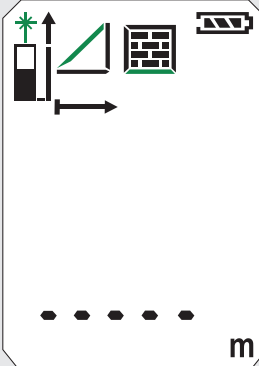
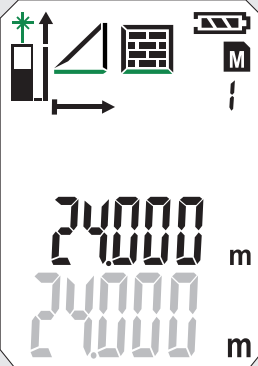
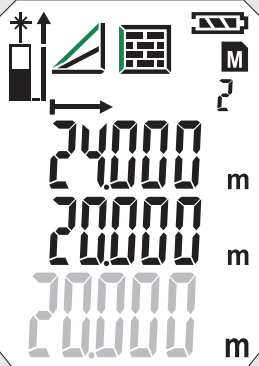
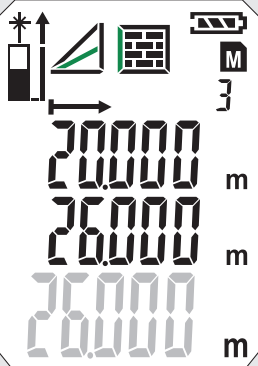
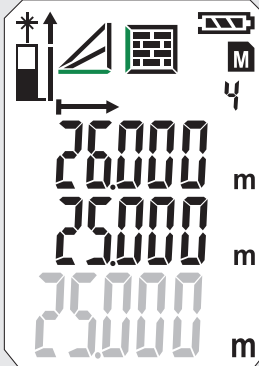

WANDFLÄCHENMESSUNG (SZENARIO 2)

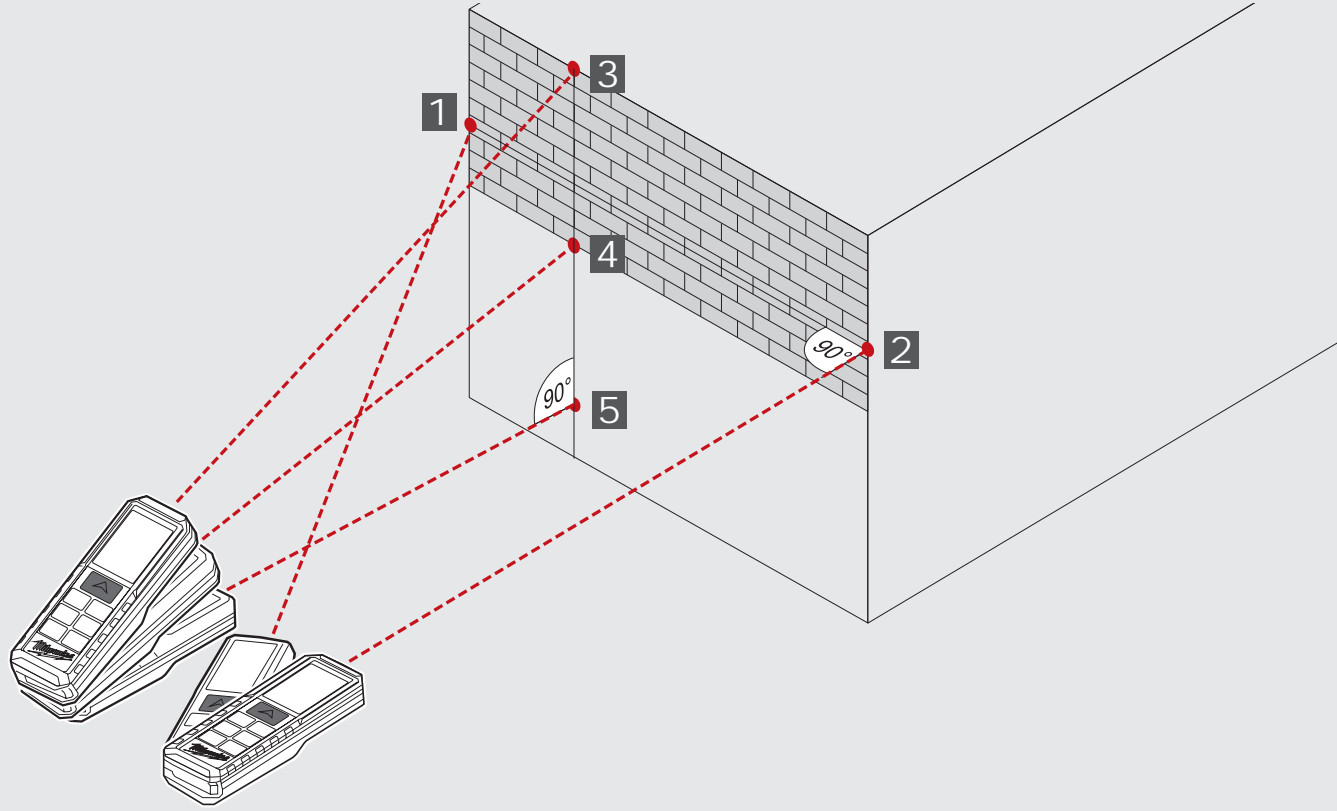
<p>0</p> 	<p>1</p> 	<p>2</p> 	<p>3</p> 	<p>4</p> 
				



5



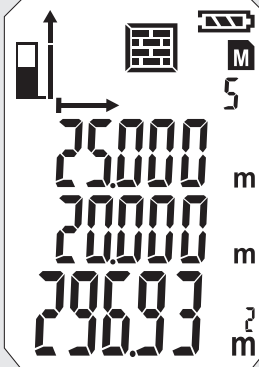

TIMER

Mit dem Timer kann die Messung verzögert ausgelöst werden, um z. B. ein Bauteil im Messstrahl zu positionieren.

Taste  drücken

- Symbol erscheint
- Durch Drücken der Taste  kann der Timer zwischen 3 und 15 sek eingestellt werden.

Taste  drücken

- Die Sekunden werden bis zur Messung heruntergezählt.
- Bei 0 wird die Messung ausgelöst.

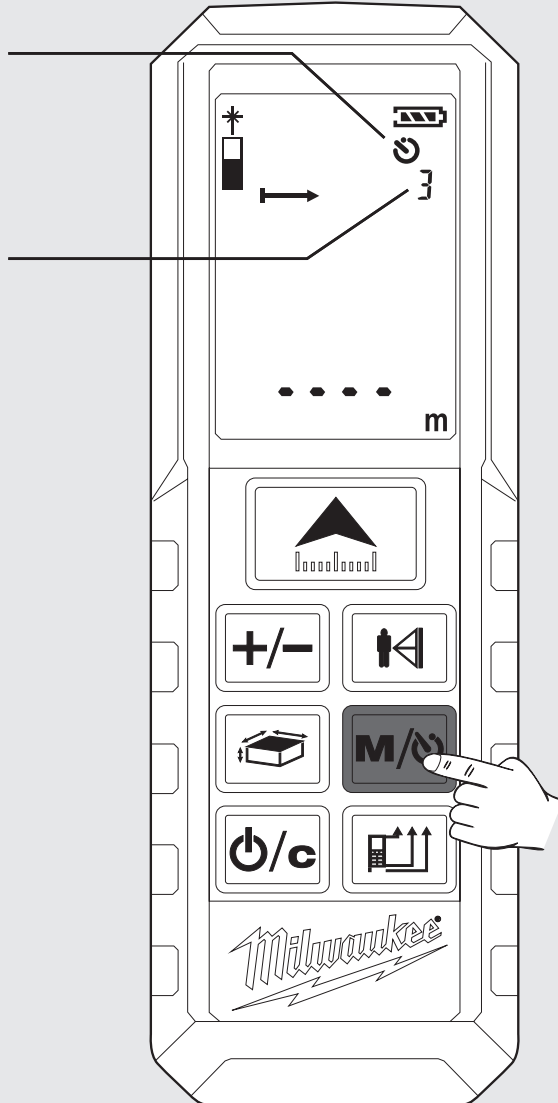

SPEICHER

Die Messwerte werden automatisch fortlaufend im Speicher abgelegt.

Die gespeicherten Werte können mit der Taste  abgerufen werden.

Taste  2 sek drücken

- Symbol und Speicherplatz erscheint.
- Zugehörige Messgröße wird angezeigt.
- Gespeicherter Wert wird in der Hauptzeile angezeigt.
- gespeicherte Werte durch wiederholtes Drücken der Taste  abrufen.

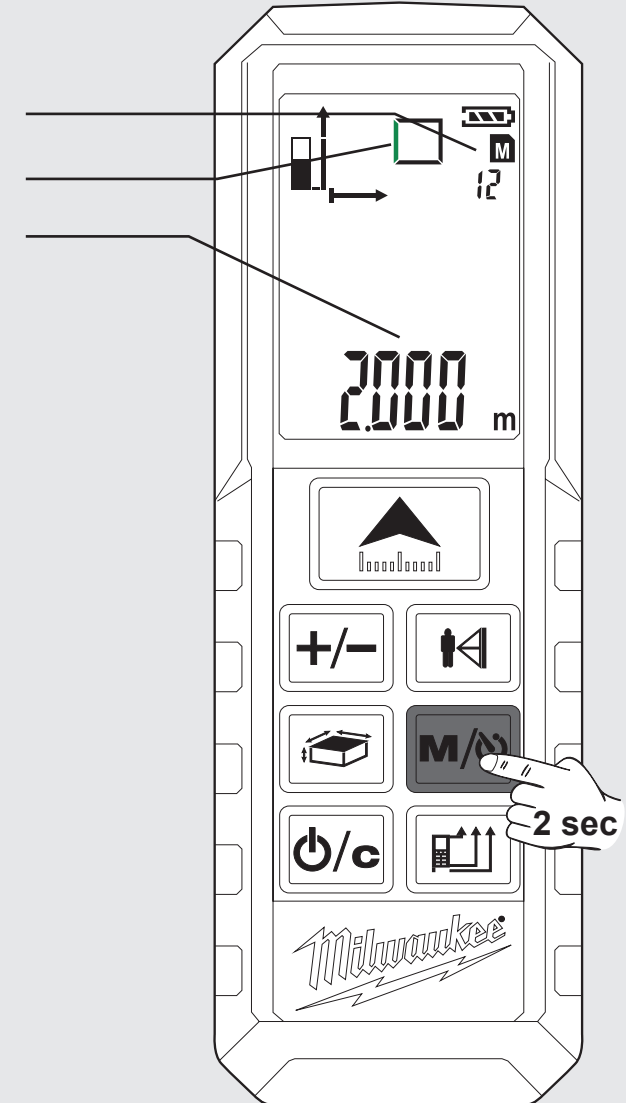

GRUNDLEGENDE FUNKTIONSWEISE AM BEISPIEL EINER FLÄCHENMESSUNG (1)

1 Einschalten

Taste  drücken.

Achtung! Laserstrahl an!
Nicht auf Personen richten!

2 Messebene wählen

Standardeinstellung nach dem Einschalten: hinten

 1x drücken -> Eckenstift
2x drücken -> vorn
3x drücken -> hinten

3 Funktion wählen

Nach dem Einschalten steht das Gerät immer auf Längenmessung.

 1x drücken - Flächenmessung

4 Länge messen

Gerät ausrichten und Taste  drücken

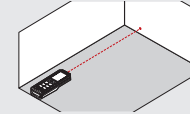

5 Breite messen

Gerät ausrichten und Taste  drücken

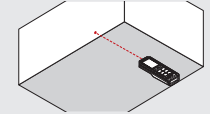

Lasersymbol blinkt (blinken grün dargestellt).

Symbol wird angezeigt

- Symbol erscheint
- Messgröße blinkt (blinken grün dargestellt)

- Messwert erscheint kurz in der Hauptzeile.
- Messwert springt nach 1 sek in darüberliegende Zeile.
Messwert wird im Speicher unter fortlaufender Nummer abgelegt.
Zweite Messgröße blinkt.
Gerät bereit für Messung des zweiten Wertes.

- Messwert erscheint kurz in der Hauptzeile.
- Messwert springt nach 1 sek in darüberliegende Zeile.
Messwert wird im Speicher unter fortlaufender Nummer abgelegt.
- Ergebnis wird in Hauptzeile angezeigt und im Speicher unter fortlaufender Nummer abgelegt.

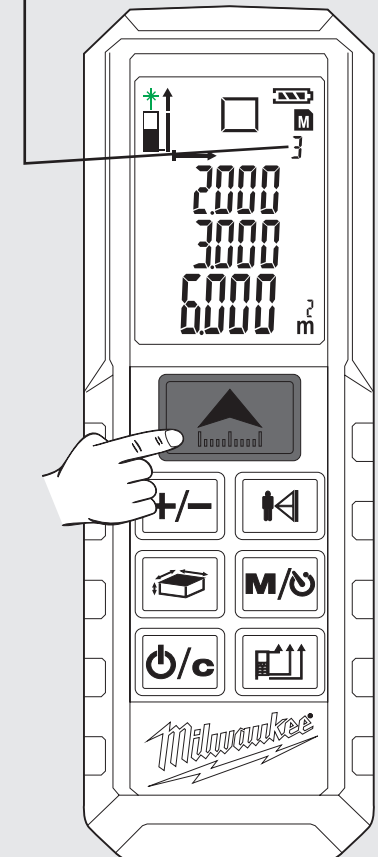
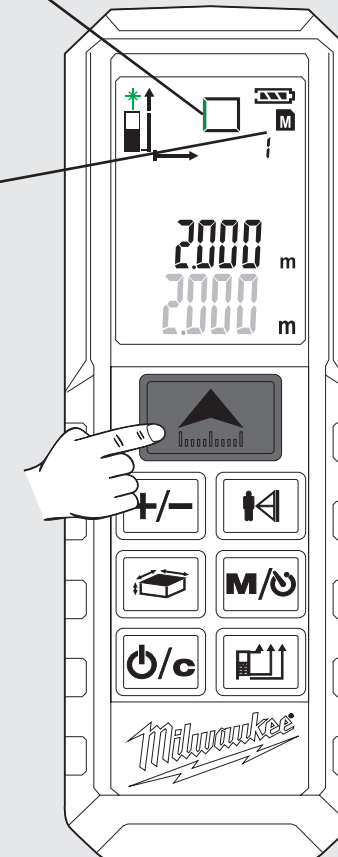
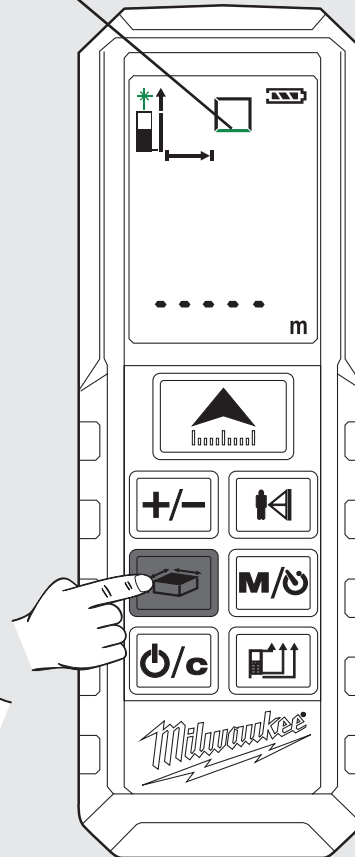
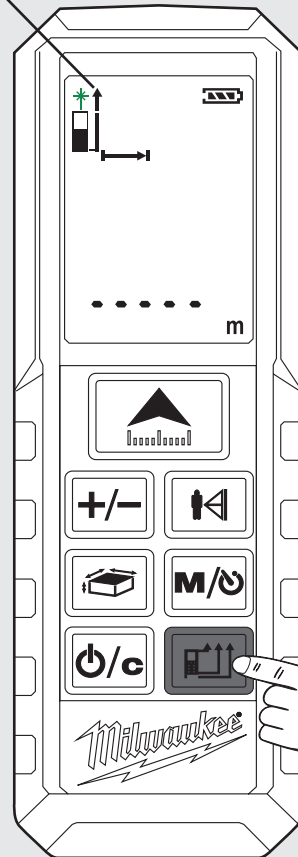
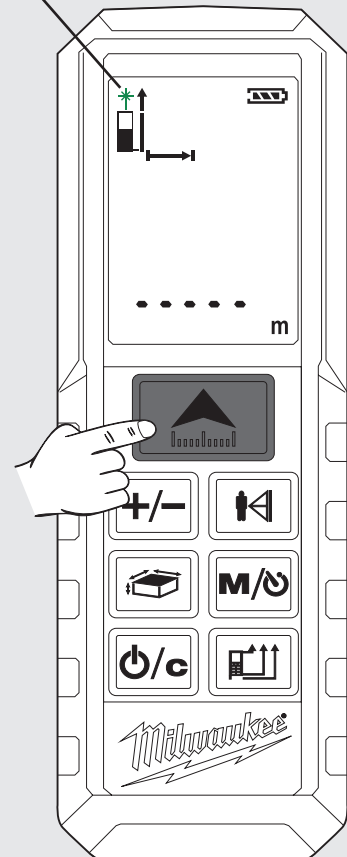

GRUNDLEGENDE FUNKTIONSWEISE AM BEISPIEL EINER FLÄCHENMESSUNG (2)

6 Gespeicherte Werte abrufen

Taste **M/0** 2 sek drücken.
Taste **M/0** wiederholt drücken

7 Speicher verlassen

Taste **0/c** drücken

8 Ausschalten

Taste **0/c** 2 sek drücken
(Speicher muss vorher verlassen werden).

- Gespeicherte Werte werden in der Hauptzeile angezeigt.
- Das zugehörige Symbol wird angezeigt und die Messgröße blinkt (blinken grün dargestellt).

- Das Gerät schaltet ab.
- Wenn 3 Minuten lang keine Taste gedrückt wird, schaltet sich das Gerät automatisch ab.

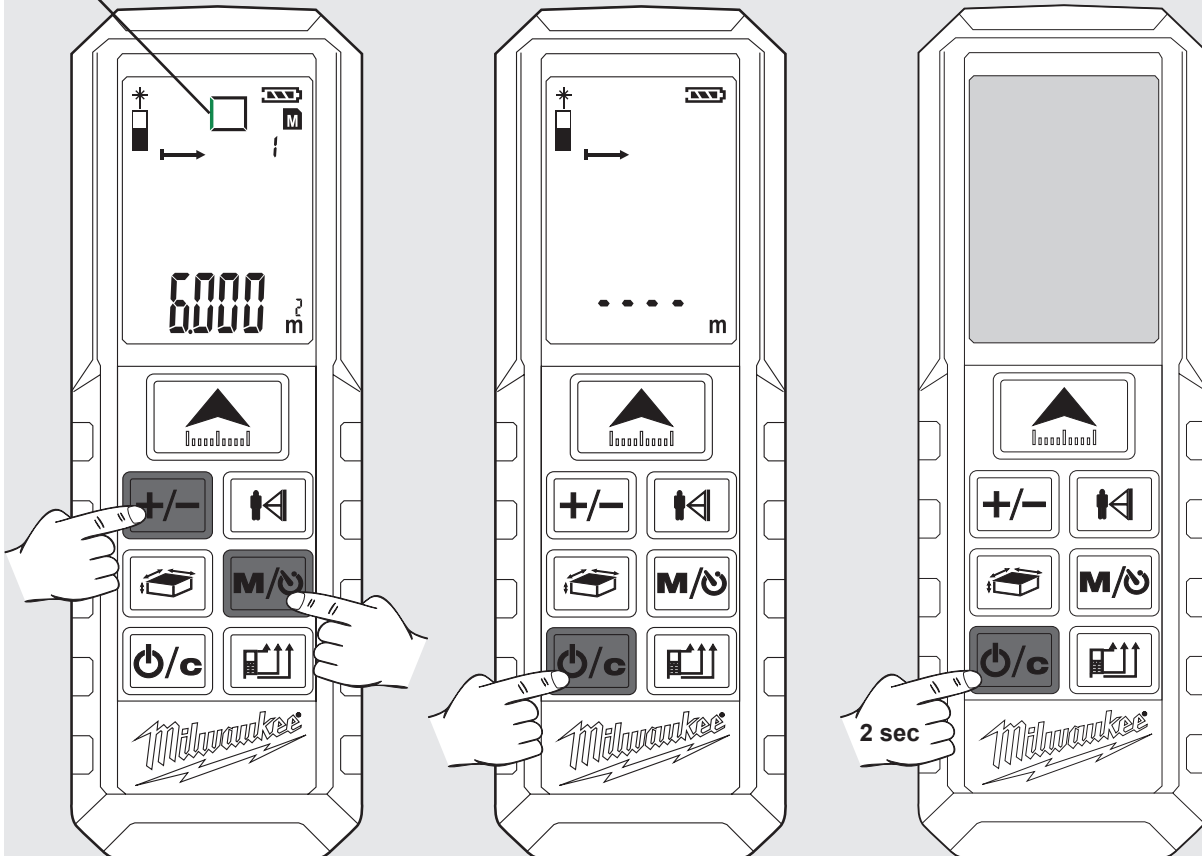



TABLE DES MATIÈRES

Consignes de sécurité importantes	1
Caractéristiques techniques	2
Utilisation conforme aux prescriptions.....	2
Tables codes erreurs	2
Panoramique	3
Remplacement batterie	4
Pointe multifonctions	4
Clip à ceinture.....	4
Touche fonction, Pythagore, plan de mesure	5
Mesure longueur simple	6
Mesure continu / mesure min. / max.	7
Mesure par addition / soustraction	8
Mesure surface.....	9
Mesure volume	10
Mesure indirecte (Pythagore 1)	11
Mesure indirecte (Pythagore 2)	12
Mesure indirecte (Pythagore 3)	13
Mesure surface paroi (scène 1).....	14
Mesure surface paroi (scène 2).....	15
Timer	16
Mémoire.....	16
Fonctionnement de base exemplifié pour la mesure de la surface (1)	17
Fonctionnement de base exemplifié pour la mesure de la surface (2)	18

CONSIGNES DE SÉCURITÉ IMPORTANTES

  N'utilisez pas ce produit avant d'avoir lu les consignes de sécurité et le manuel de l'utilisateur chargés sur le CD joint.

Classement laser

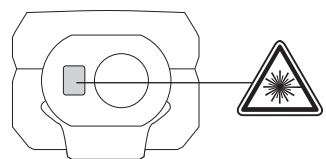

AVERTISSEMENT:
Ce produit fait partie de la classe laser 2 au sens de la norme EN60825-1:2014.

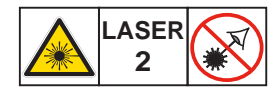

λ 650 nm P<1 mW

Avis :
Éviter tout contact visuel direct. Le rayon laser peut causer un aveuglement temporaire type flash aux yeux.
Ne regardez pas dans le faisceau laser et ne le dirigez pas inutilement sur d'autres personnes.
N'éblouissez pas d'autres personnes.

Avis :
Ne pas employer le dispositif au laser près des enfants et ne pas permettre aux enfants d'employer le dispositif au laser
Attention ! Des surfaces réfléchissantes pourraient réfléchir le rayon laser sur l'opérateur ou sur des autres personnes.

Se tenir à distance des pièces en mouvement.
Effectuez régulièrement des mesures d'essai, en particulier avant, pendant et après des mesures importantes.
Attention: si le produit est défectueux, est tombé, a été utilisé de manière non conforme ou modifié, il peut fournir des mesures incorrectes

Avis : L'utilisation d'éléments de contrôle, de sélections ou l'exécution de procédures différentes de celles établies par le guide pourra comporter une dangereuse exposition aux rayons.

Le dispositif de mesure laser a une plage d'application limitée. (Voir chapitre "Données techniques"). Tout essai de mesure hors de la plage max. ou min. produira des résultats imprécis. L'utilisation en présence de conditions atmosphériques défavorables, telles que températures très hautes ou très basses, lumière solaire très intense, pluie, neige, brouillard ou toute autre condition limitant la visibilité, pourra comporter des mesures imprécises.

Si le dispositif de mesure laser est déplacé d'un site chaude à un site froid (ou vice-versa) il faut attendre pour permettre au dispositif de s'adapter à la nouvelle température ambiante.

Conserver toujours le dispositif de mesure laser dans un endroit fermé et le protéger contre les chocs, les vibrations et les températures extrêmes.

Protéger le dispositif de mesure laser contre les poussières, les liquides et la haute humidité de l'air. Les facteurs susdits pourraient endommager gravement les composants internes ou influencer négativement sa précision.

Ne pas utiliser des détergents agressifs ou des solvants. Nettoyer uniquement avec un chiffon propre et doux.

Éviter de forts chocs sur le dispositif de mesure laser ou sa chute. Après une chute du dispositif de mesure laser ou après son exposition à d'autres sollicitations mécaniques, il est nécessaire de contrôler la précision du dispositif.

Les réparations éventuellement nécessaires sur le dispositif au laser sont à effectuer exclusivement par du personnel spécialisé autorisé !

N'utilisez pas le produit dans des zones à risque d'explosion ou dans des environnements agros- sifs.

Recharger seulement les batteries avec les chargeurs recommandés par le fabricant.

 Les déchets de piles et les déchets d'équipements électriques et électroniques (déchets d'équipements électriques et électroniques) ne sont pas à éliminer dans les déchets ménagers. Les déchets de piles et les déchets d'équipements électriques et électroniques doivent être collectés et éliminer séparément.

Retirez les déchets de piles, les déchets d'accumulateurs et les ampoules des appareils avant de les jeter.

S'adresser aux autorités locales ou au détaillant spécialisé en vue de connaître l'emplacement des centres de recyclage et des points de collecte.

Selon les réglementations locales, les détaillants peuvent être tenus de reprendre gratuitement les déchets de piles et les déchets d'équipements électriques et électroniques.

Contribuez à réduire la demande de matières premières en réutilisant et en recyclant vos déchets de piles et d'équipements électriques et électroniques.

Les déchets de piles (surtout les piles au lithium-ion) et les déchets d'équipements électriques et électroniques comportent des matériaux précieux et recyclables qui peuvent avoir des impacts négatifs sur l'environnement et sur votre santé s'ils ne sont pas éliminés de manière écologique.

Avant de mettre au rebut votre ancien appareil, supprimez les données personnelles qui pourraient s'y trouver.

 Marque de conformité européenne

 Marque de conformité britannique

 Marque de conformité ukrainienne

 Marque de conformité d'Eurasie

CARACTÉRISTIQUES TECHNIQUES

Classe de protection	IP54 (protection contre les poussières et les projections d'eau)
Optique	14 mm
Point focal	35 mm
Plage de mesure max.	50 mètres (tolérance: 55m)
Plage de mesure min.tab#0,05 mètres	0,05 Meter
Précision absolue @ < 10m	± 1,5 mm (max)
Précision de répétabilité @ < 10m	± 1,5 mm (typiquement max. 2σ)
Précision de répétabilité @ > 10m	montée± 0,25 mm / mètre (typiquement max. 2σ)
Temps de mesure	0,5 s
Afficheur type	LCD (22,7 mm x 31 mm)
Alimentation	AAA 2x (batterie alcaline)
Durée batterie	10000 (mesures individuelles)
Puissance de sortie laser	0,6 mW ~ 0,95 mW (Classe 2, 650nm)
Dimension point laser	25 x 30 mm @ 16 m (max)
Classe laser	2
Type laser	650 nm, < 1 mW
Rayon laser angle vertical	+1 degré
Rayon laser angle horizontal	±1 degré
Coupure automatique dispositif	180 secondes
Coupure automatique laser	30 secondes
Plage température d'utilisation	de -10°C à +50°C
Plage température de stockage	de -25°C à +70°C
Poids sans batterie	80 g

UTILISATION CONFORME AUX PRESCRIPTIONS

Le dispositif de mesure laser est apte à mesurer des distances et des inclinaisons.

Comme déjà indiqué, cette machine n'est conçue que pour être utilisée conformément aux prescriptions.

TABLES CODES ERREURS

Code	Description	Solution
Err01	Hors de la plage de mesure	Mesurer dans la plage prévue.
Err02	Signal réfléchi trop faible	Choisir une surface plus appropriée.
Err03	Hors de la plage de visualisation (valeur max: 99.999) est par exemple le résultat d'une surface ou d'un volume hors de la plage de visualisation	Contrôler l'exactitude des valeurs et des pas.
Err04	Erreur dans le calcul de Pythagore	Contrôler l'exactitude des valeurs et des pas.
Err05	Batterie épuisée	Remplacer la batterie.
Err06	Hors de la plage de la température d'utilisation	Effectuer la mesure dans la plage prévue pour la température d'utilisation.
Err07	Éclairage excessif	Obscurcir la zone cible.

Pythagore
Différence hauteur

Plan de mesure

Mesure longueur

Min. / max. pour mesure continue

Addition / soustraction

ON / MESURER

- ▶ ON
- ▶ Mesurer
- ▶ Mesure continue (enfoncer pendant 2 sec)
Fonction min. / max.

ADDITION / SOUSTRACTION

- ▶ Addition valeur
- ▶ Navigation mémoire

SURFACE / VOLUME

- ▶ Surface (enfoncer 1x)
- ▶ Volume (enfoncer 2x)
- ▶ Mesure indirecte de la surface (enfoncer 3x / 4x)

ACTIVER

- ▶ ON
- ▶ Off (enfoncer pendant 2 sec)
- ▶ Reset

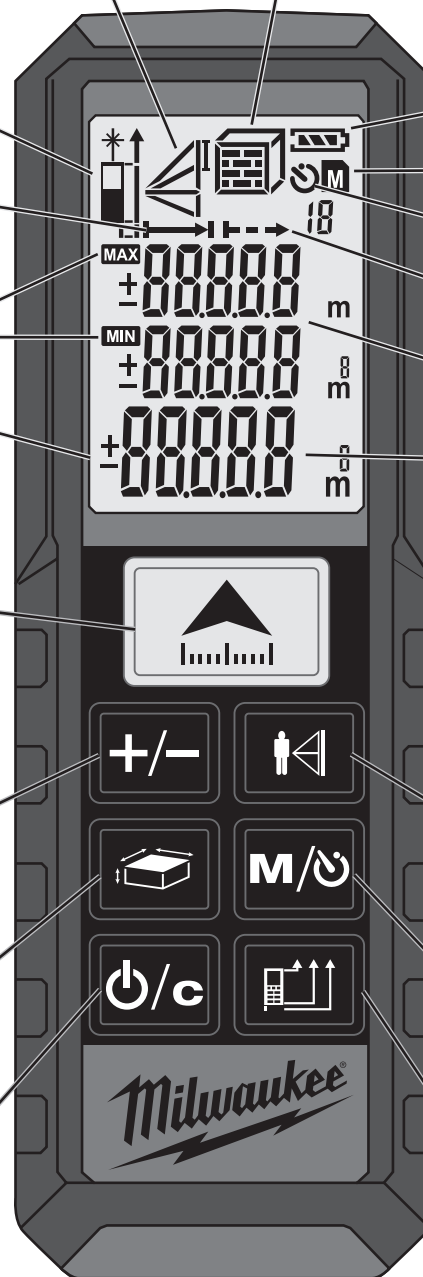

Surface / volume
Mesure indirecte de la surface

Niveau batterie

Mémoire

Timer

Mesure continue

Valeurs intermédiaires

Valeur totale

PYTHAGORE

- ▶ Pythagore 1 (enfoncer 1x)
- ▶ Pythagore 2 (enfoncer 2x)
- ▶ Pythagore 3 (enfoncer 3x)

MÉMOIRE

- ▶ Timer 3-15 sec. (enfoncer 1x)
- ▶ Mémoire 1-20 (enfoncer 1x 2 sec.)
- ▶ Lire les valeurs en mémoire (enfoncer plusieurs fois)

CHANGE PLAN DE MESURE

- ▶ Antérieur
- ▶ Postérieur
- ▶ Pointe multifonctions

REPLACEMENT BATTERIE

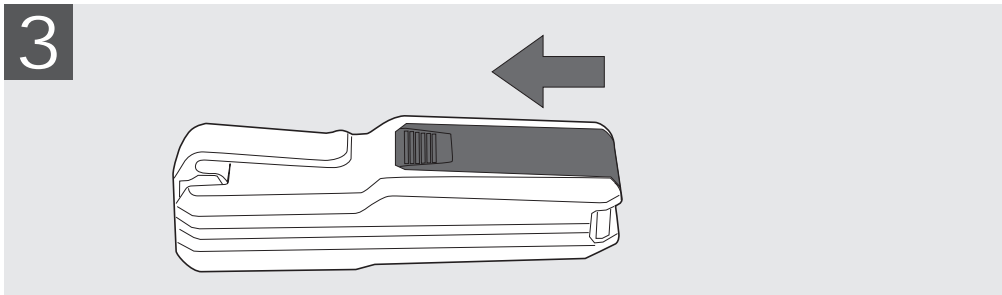
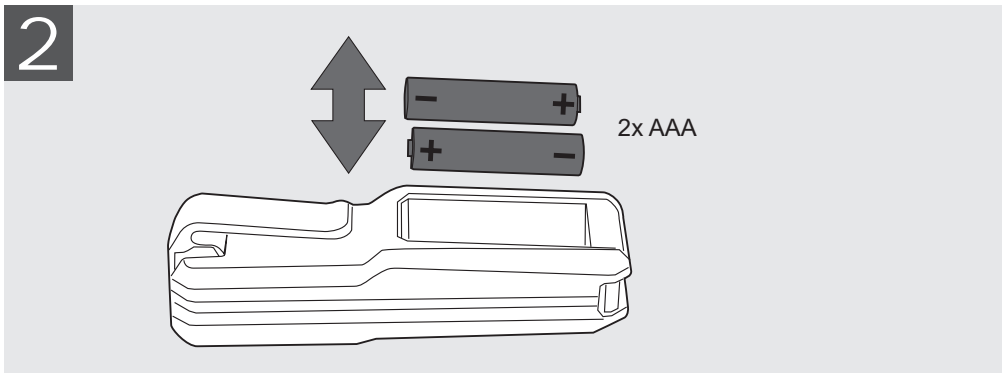
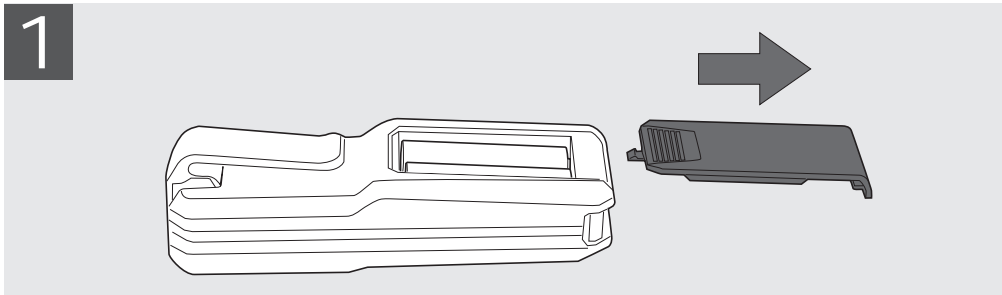
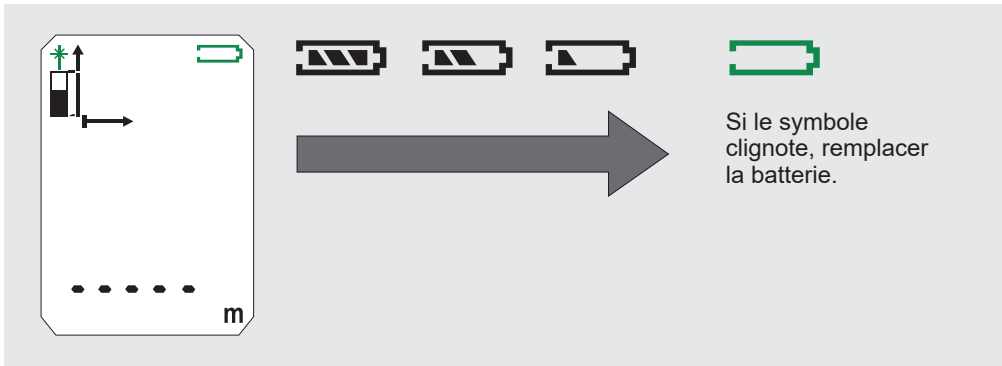

POINTE MULTIFONCTIONS

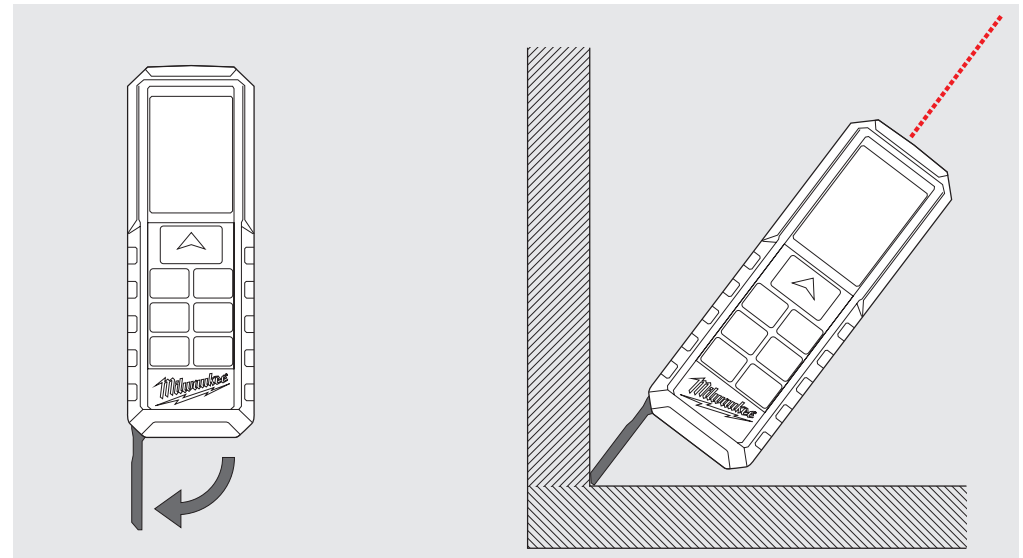

CLIP À CEINTURE

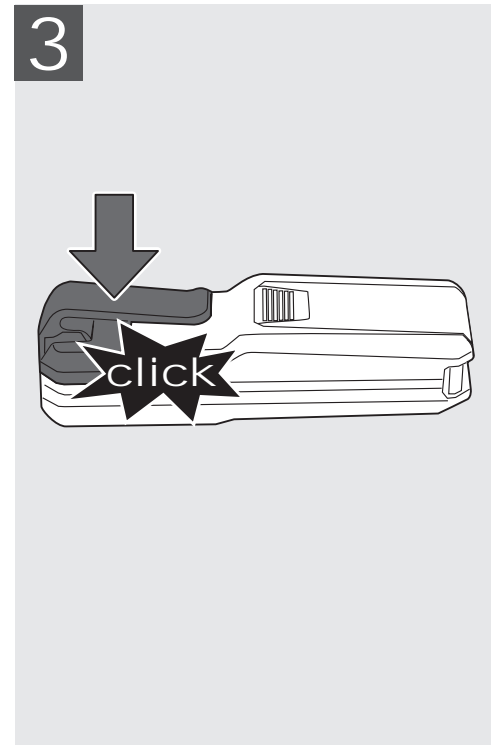
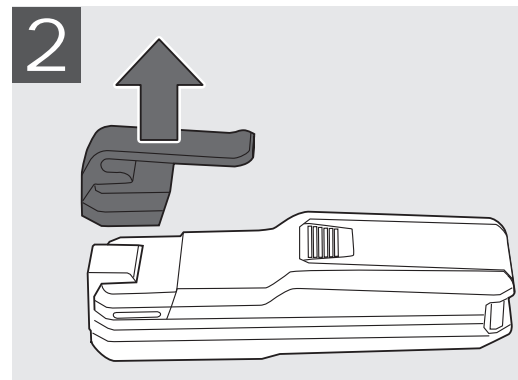
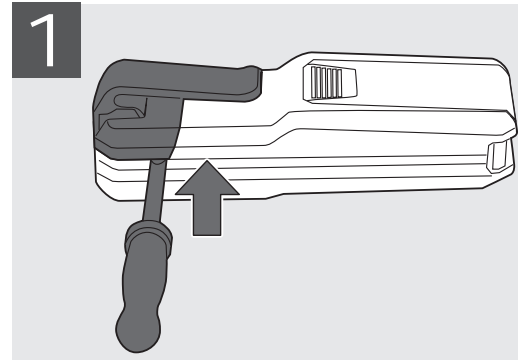

TOUCHE FONCTION, PYTHAGORE, PLAN DE MESURE

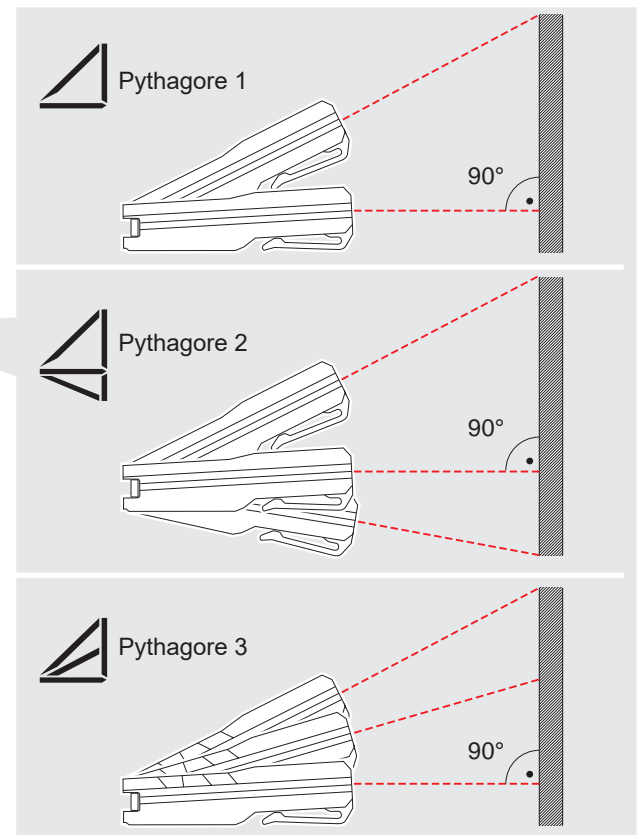
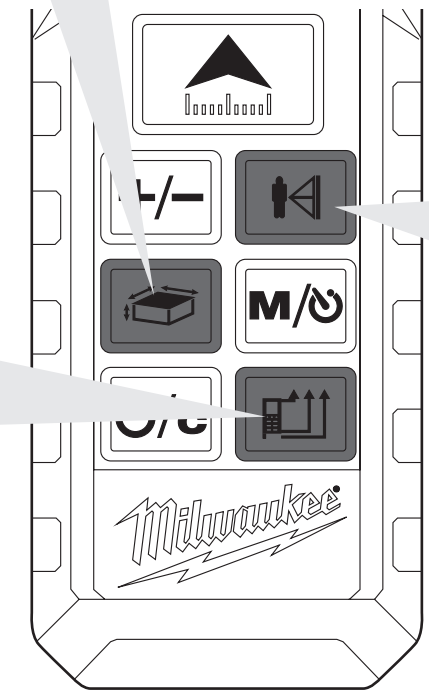
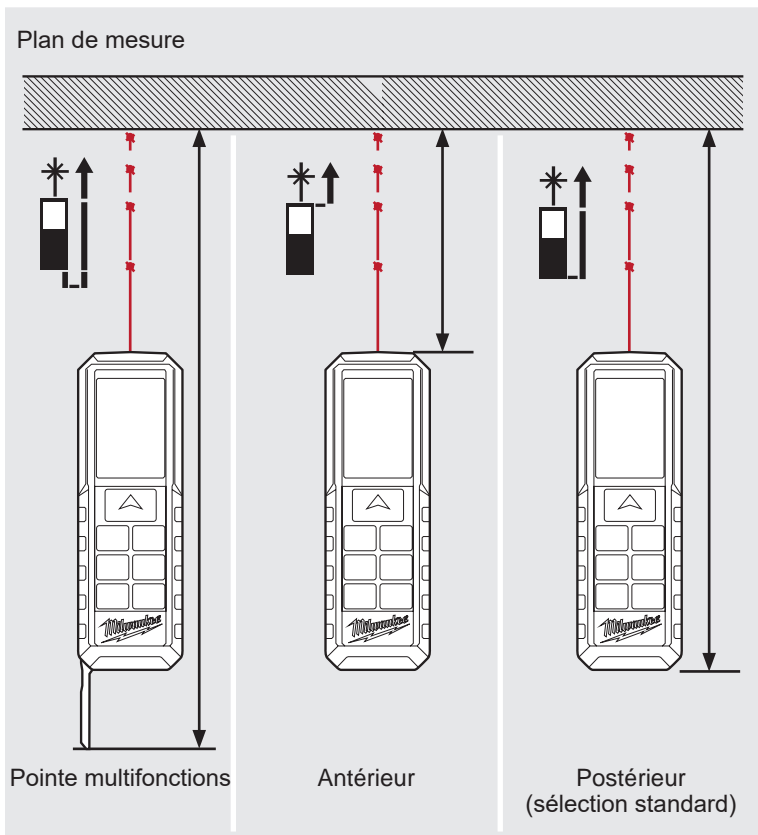
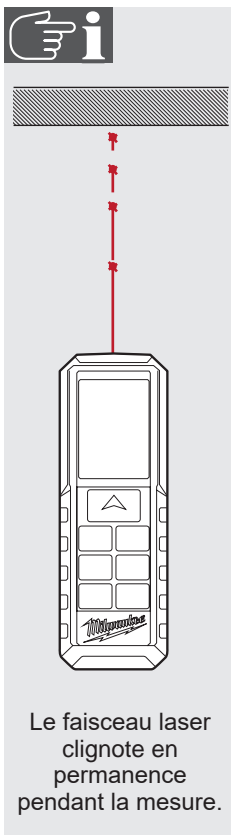
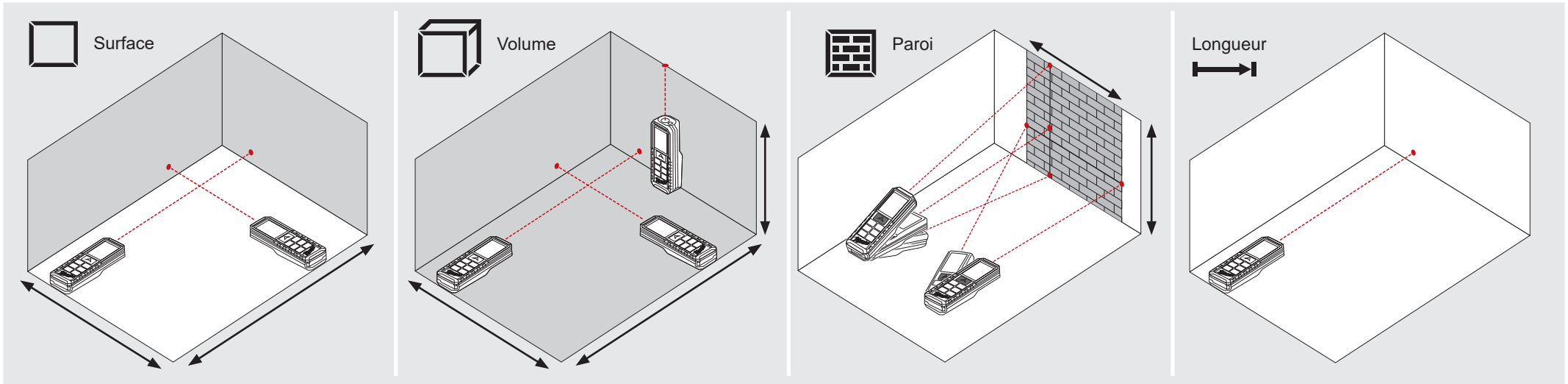

MESURE LONGUEUR SIMPLE

0

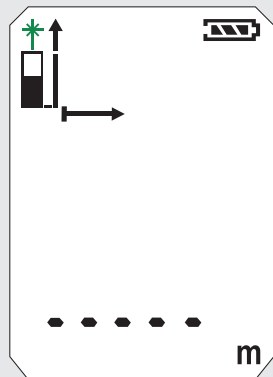

1

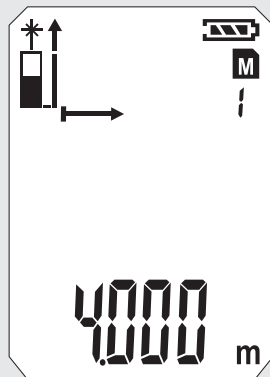

2

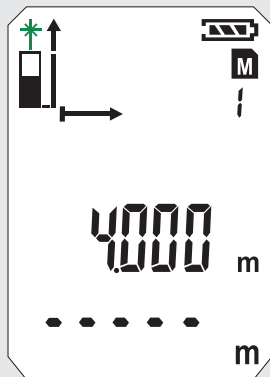

3

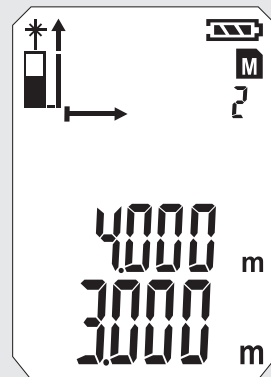

4

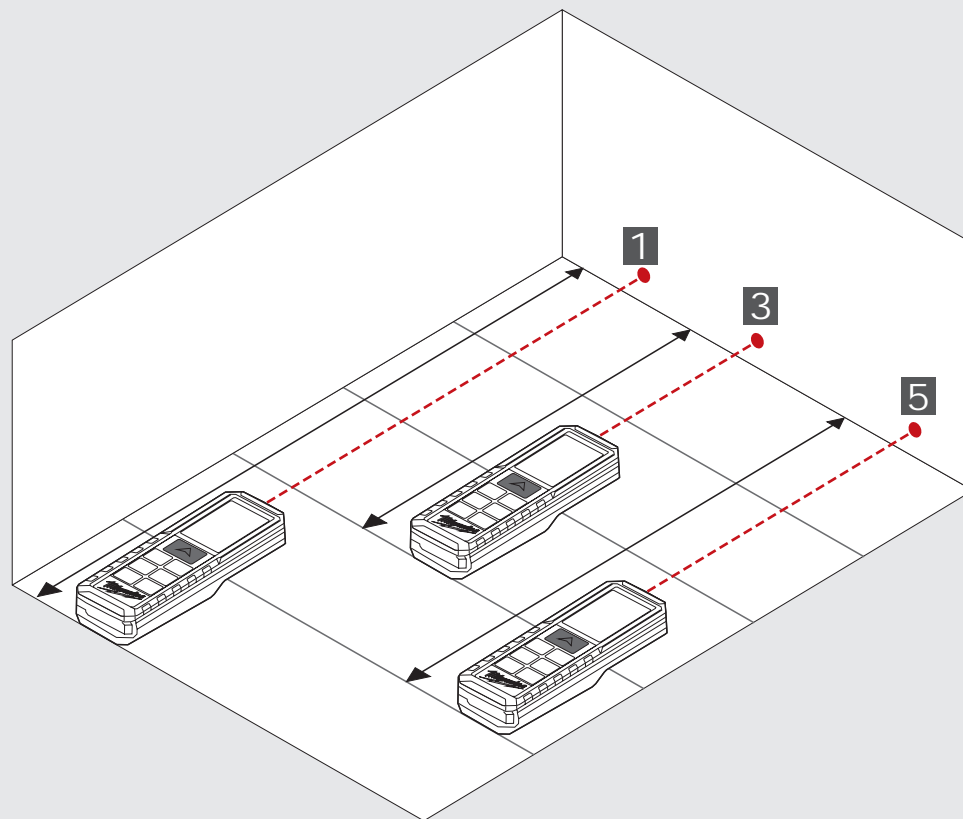
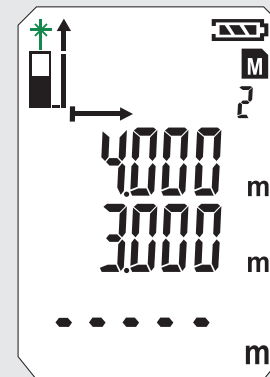

5

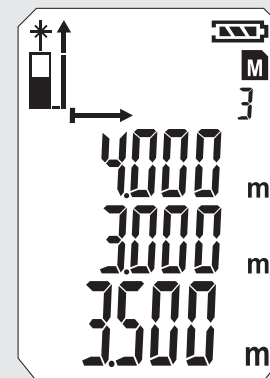

MESURE CONTINU / MESURE MIN. / MAX.

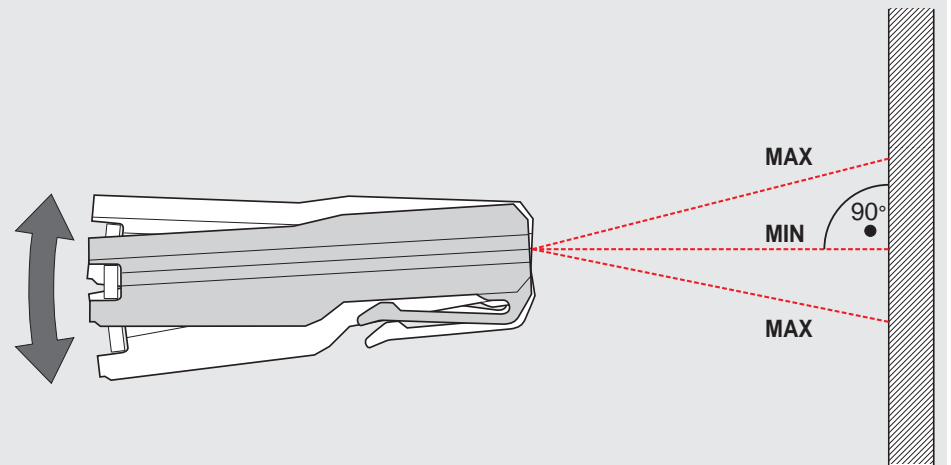
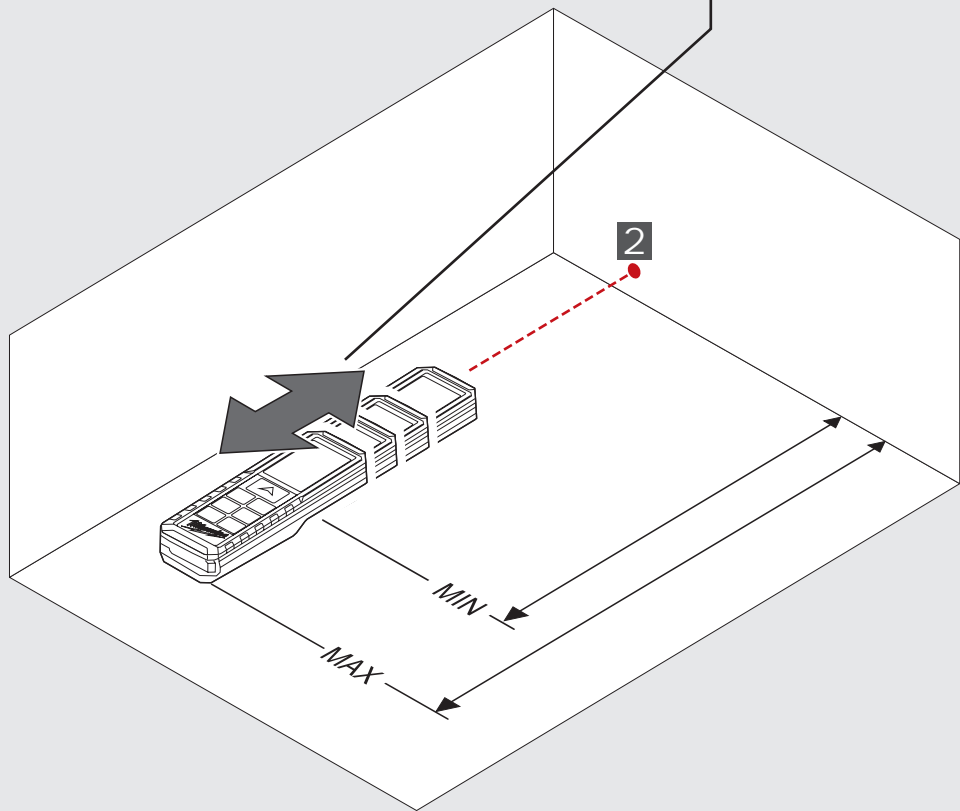
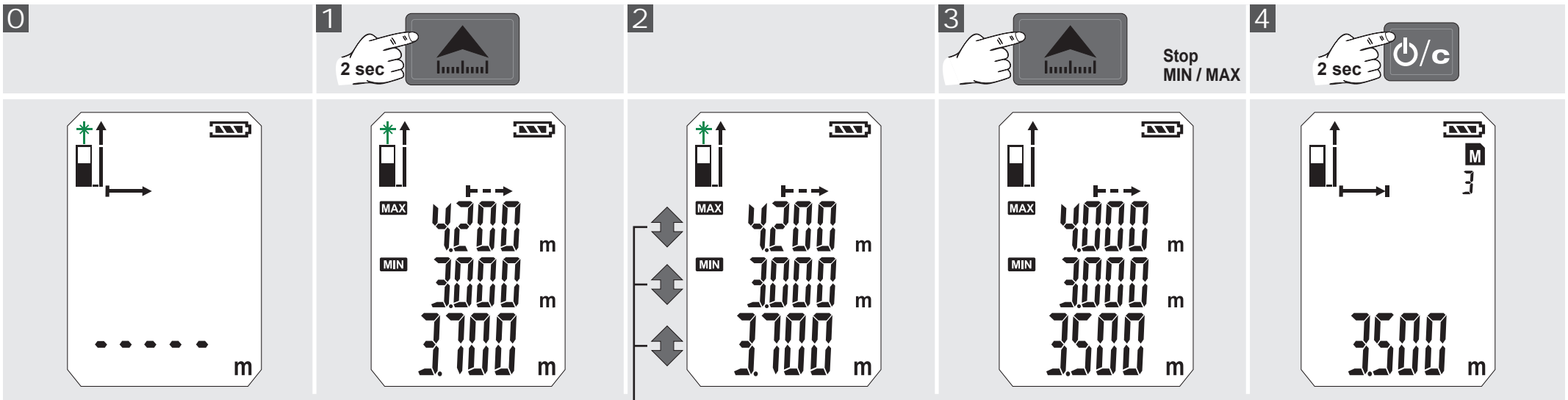

MESURE PAR ADDITION / SOUSTRACTION

0

1

2

3

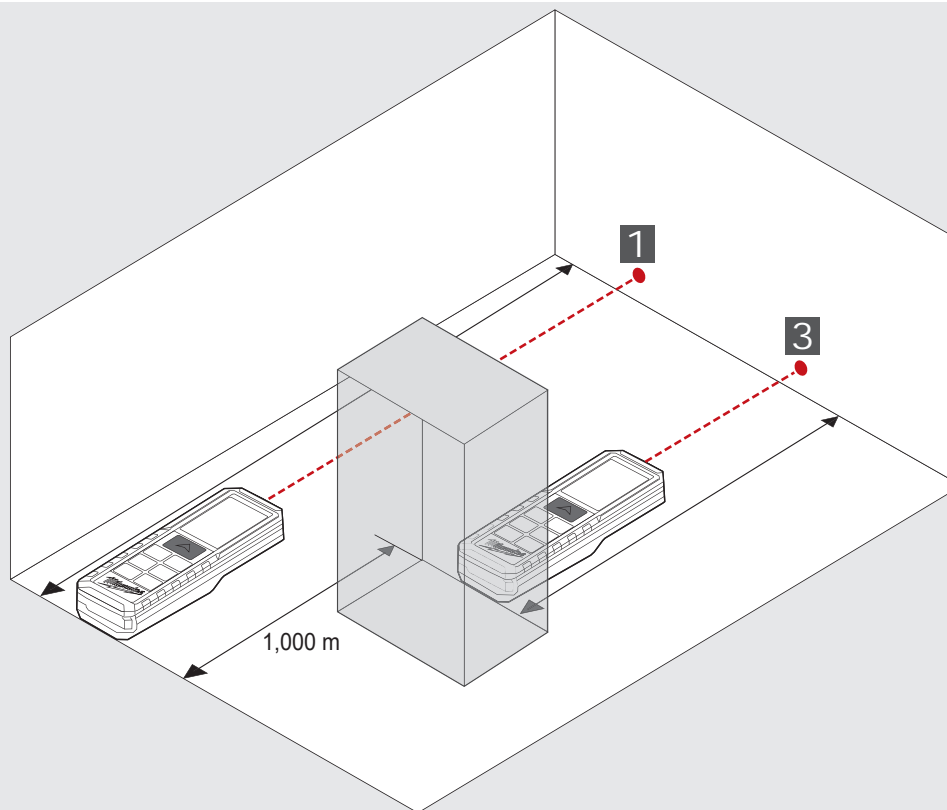
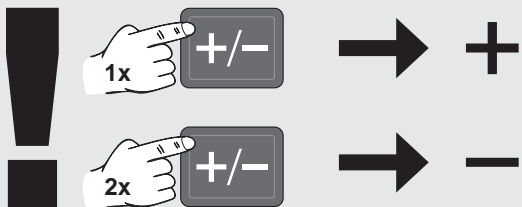
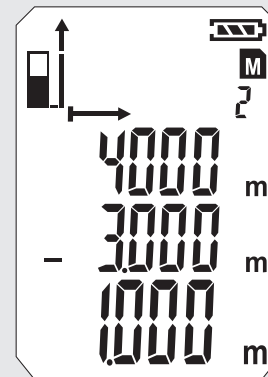
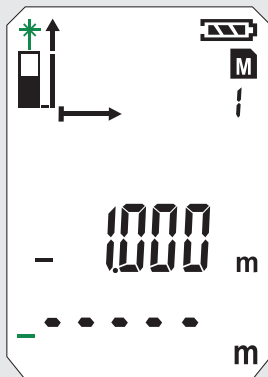
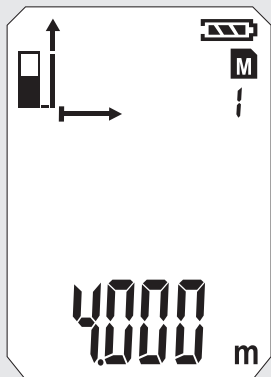
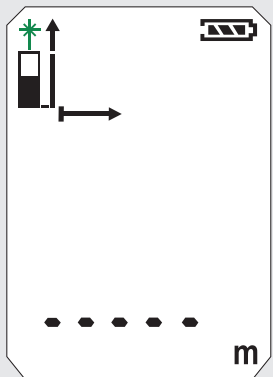

MESURE SURFACE

0



1



2

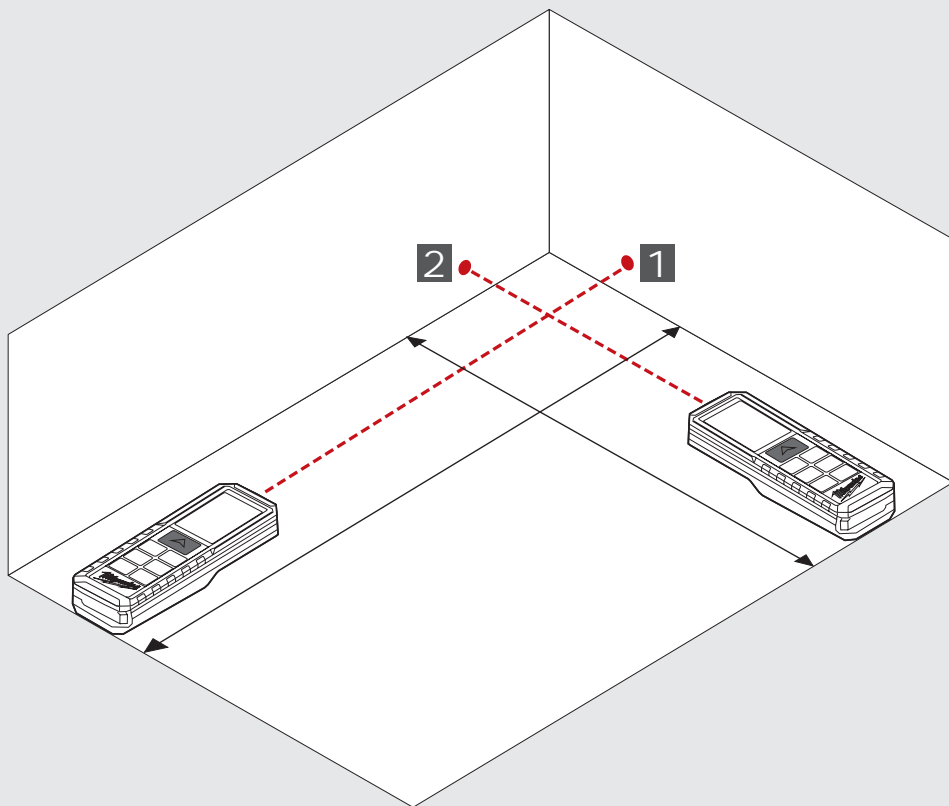
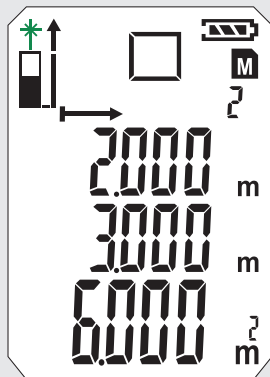
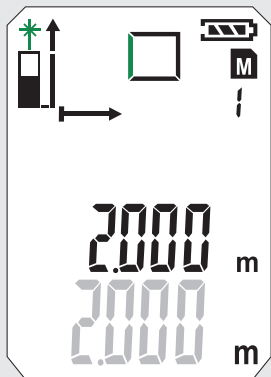
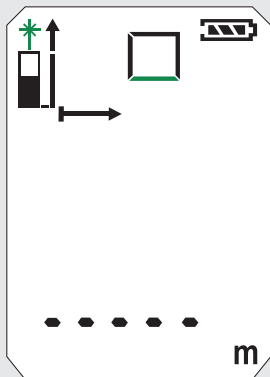

MESURE VOLUME

0



1



2



3

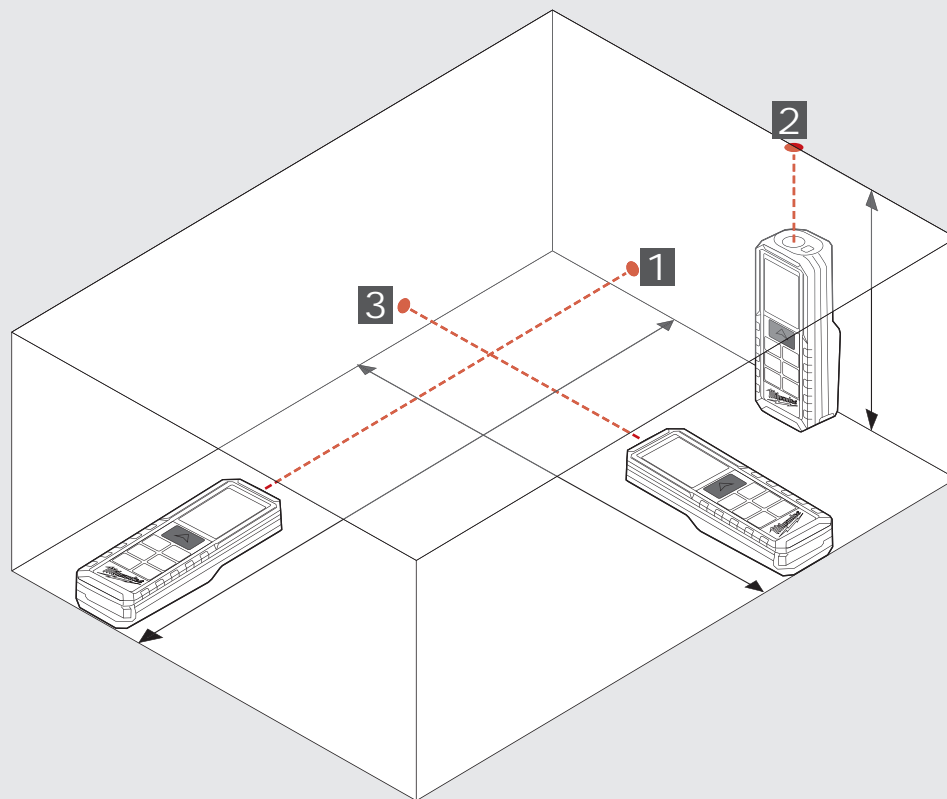
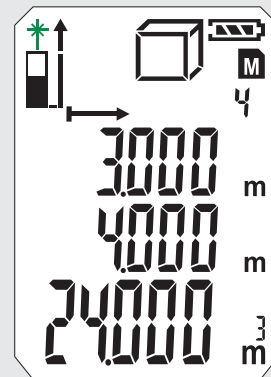
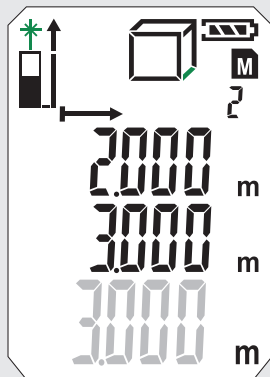
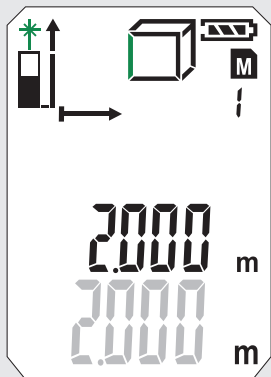
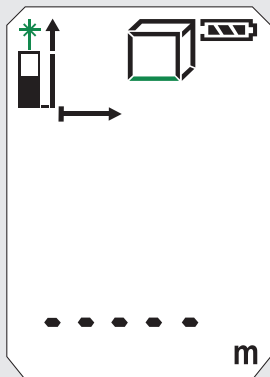

MESURE INDIRECTE (PYTHAGORE 1)

0



1 x

1



2

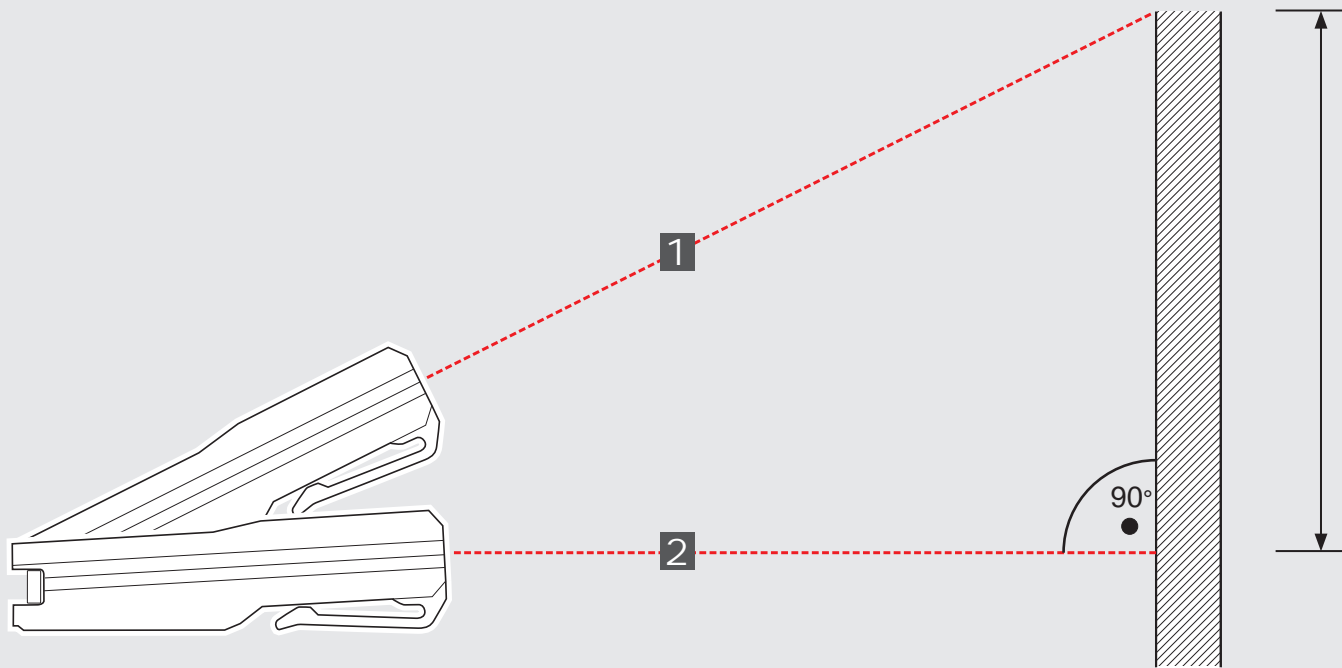
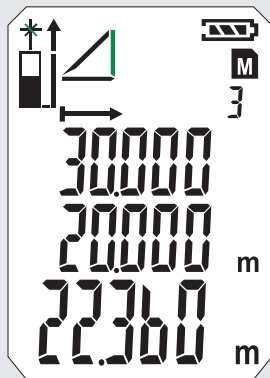
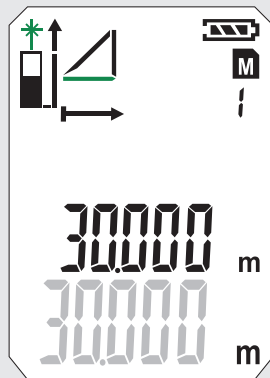
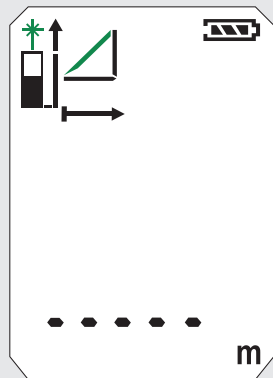

MESURE INDIRECTE (PYTHAGORE 2)

0



2 x

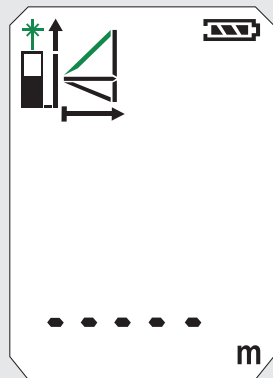

1

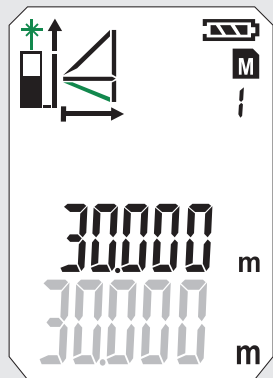

2

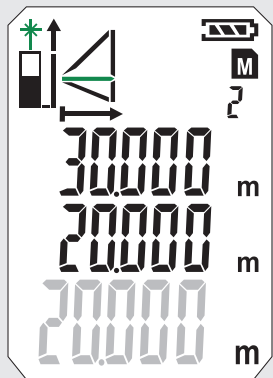

3

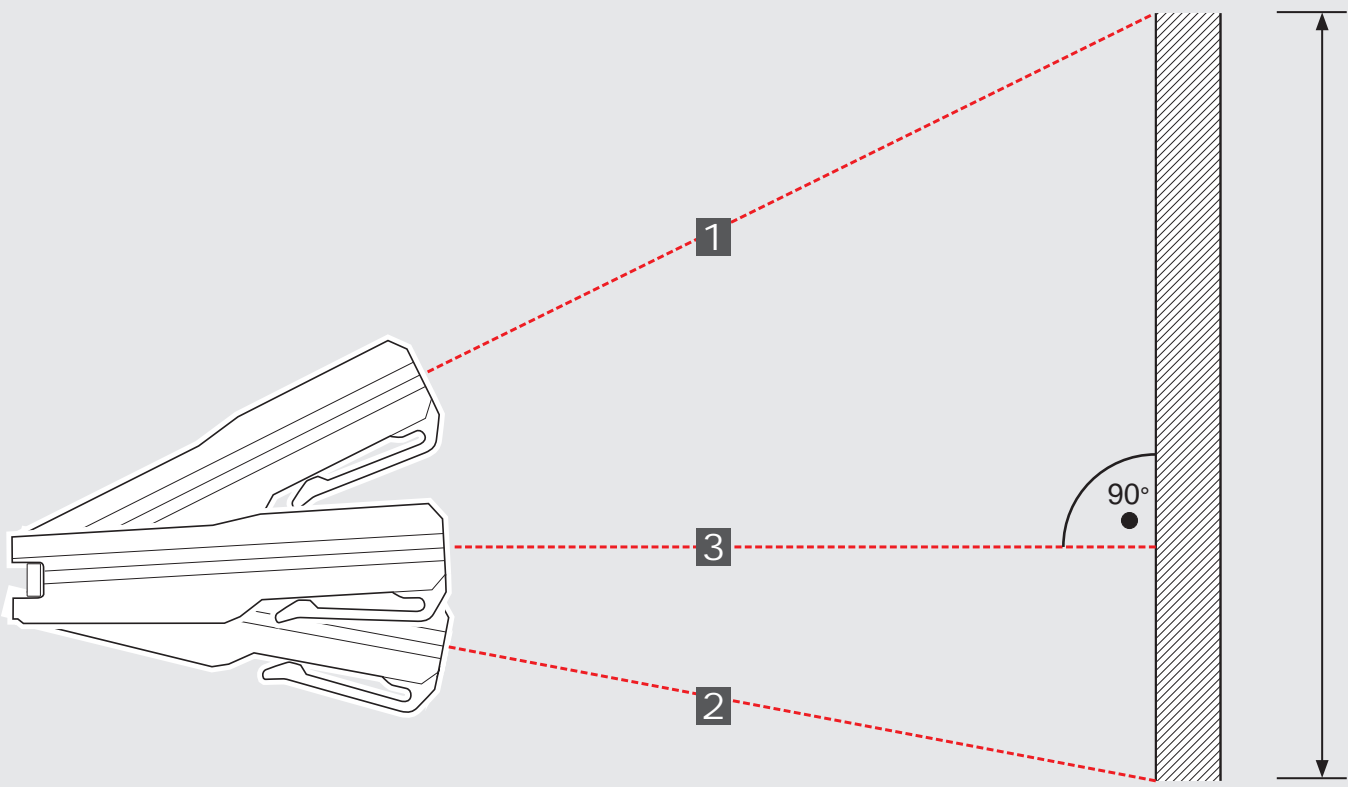
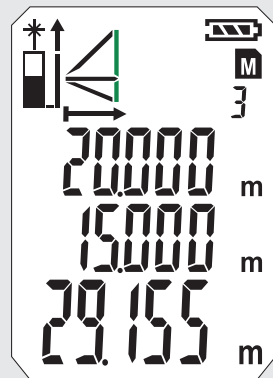

MESURE INDIRECTE (PYTHAGORE 3)

1



2







3

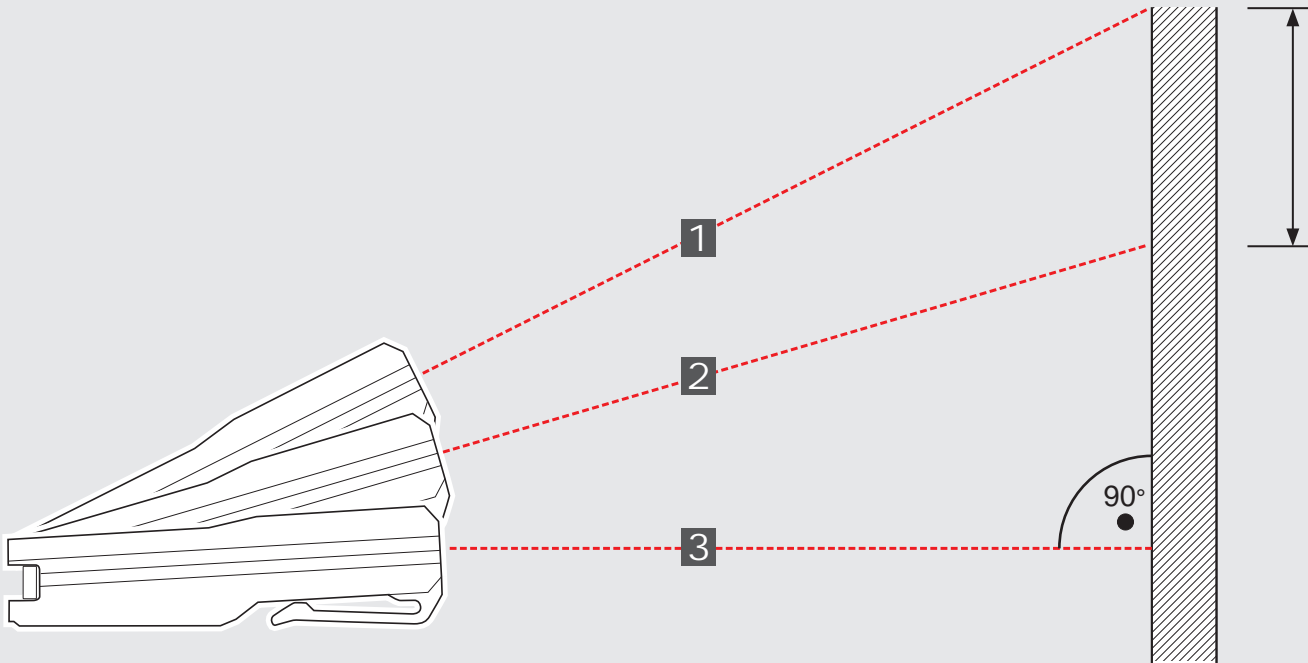
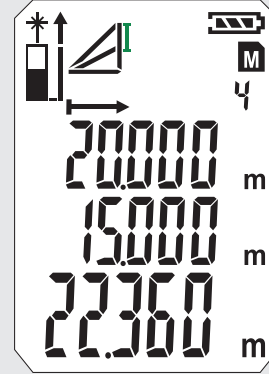
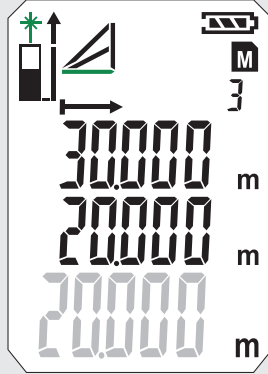
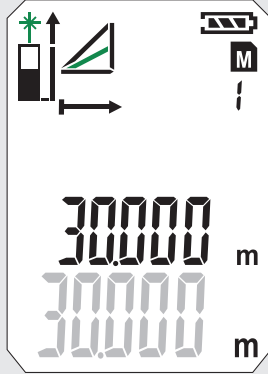
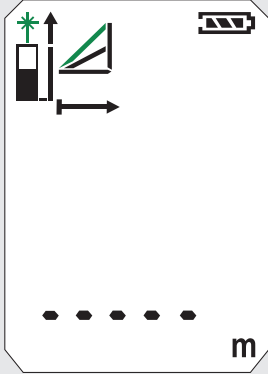



4

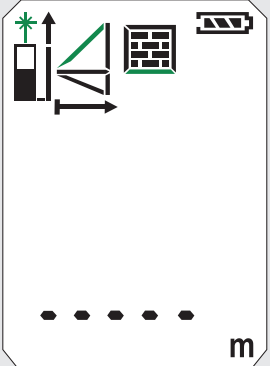
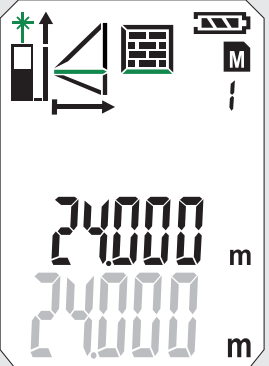
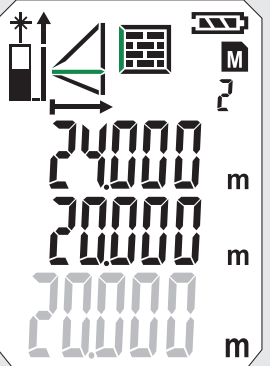
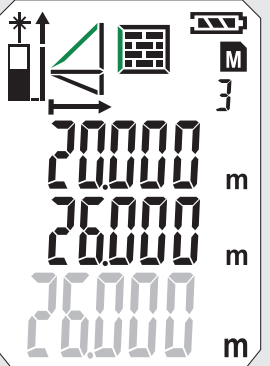
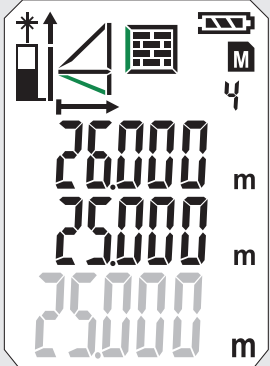

MESURE SURFACE PAROI (SCÈNE 1)

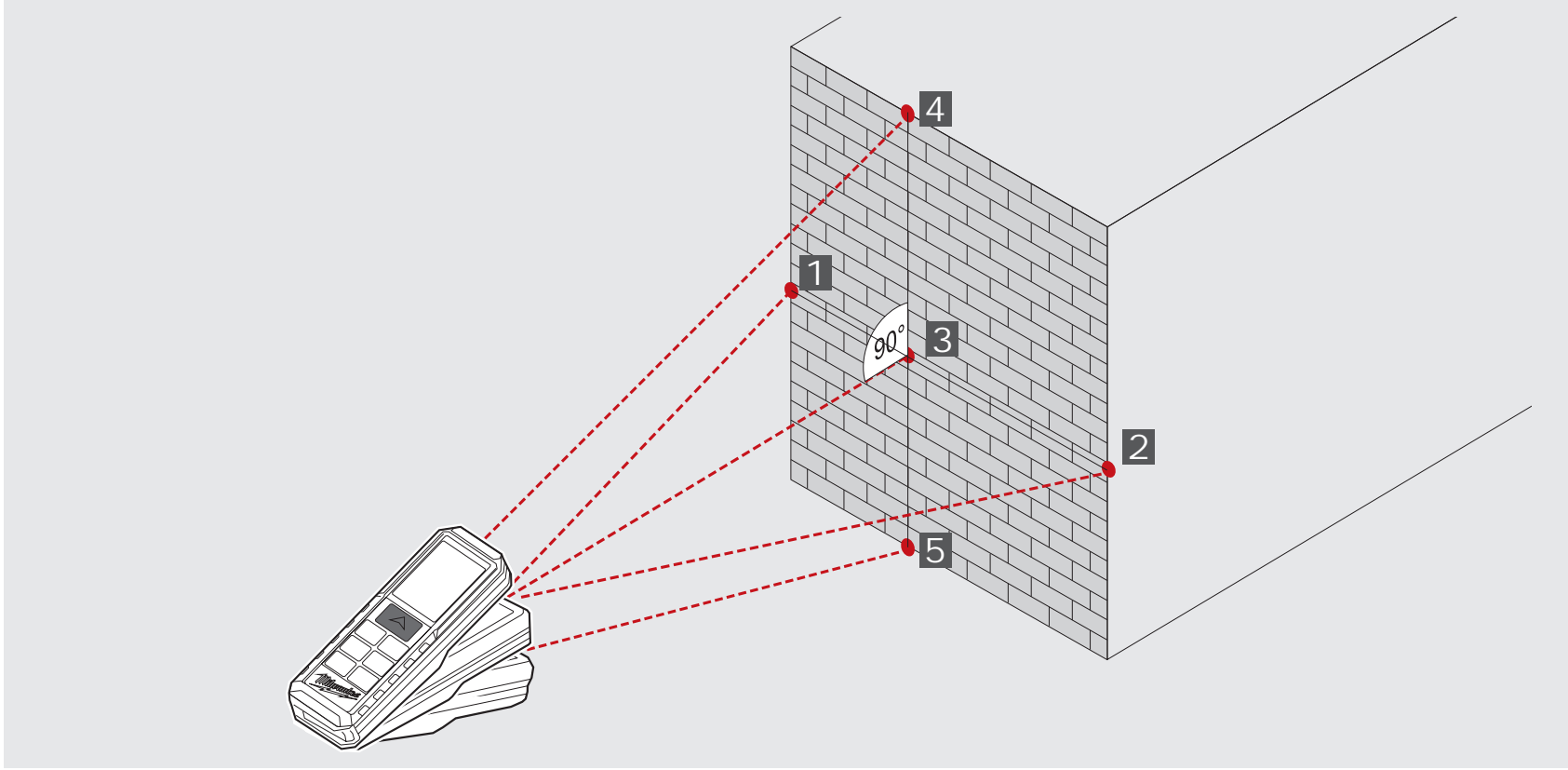



0 	1 	2 	3 	4 
				

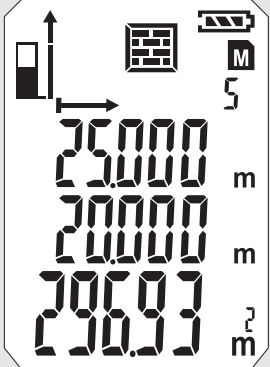

5



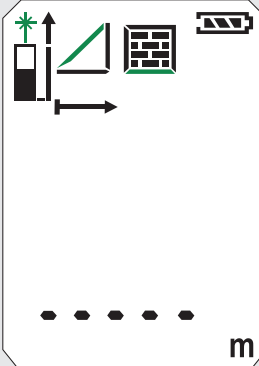
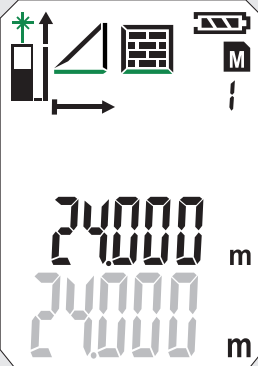
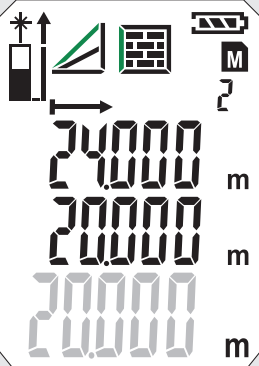
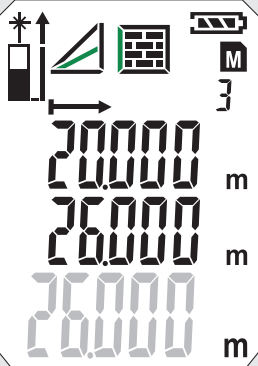
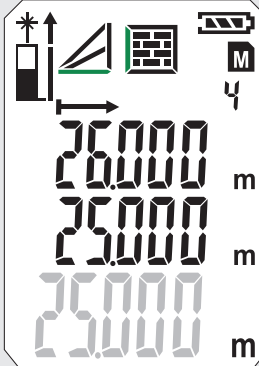

MESURE SURFACE PARI (SCÈNE 2)

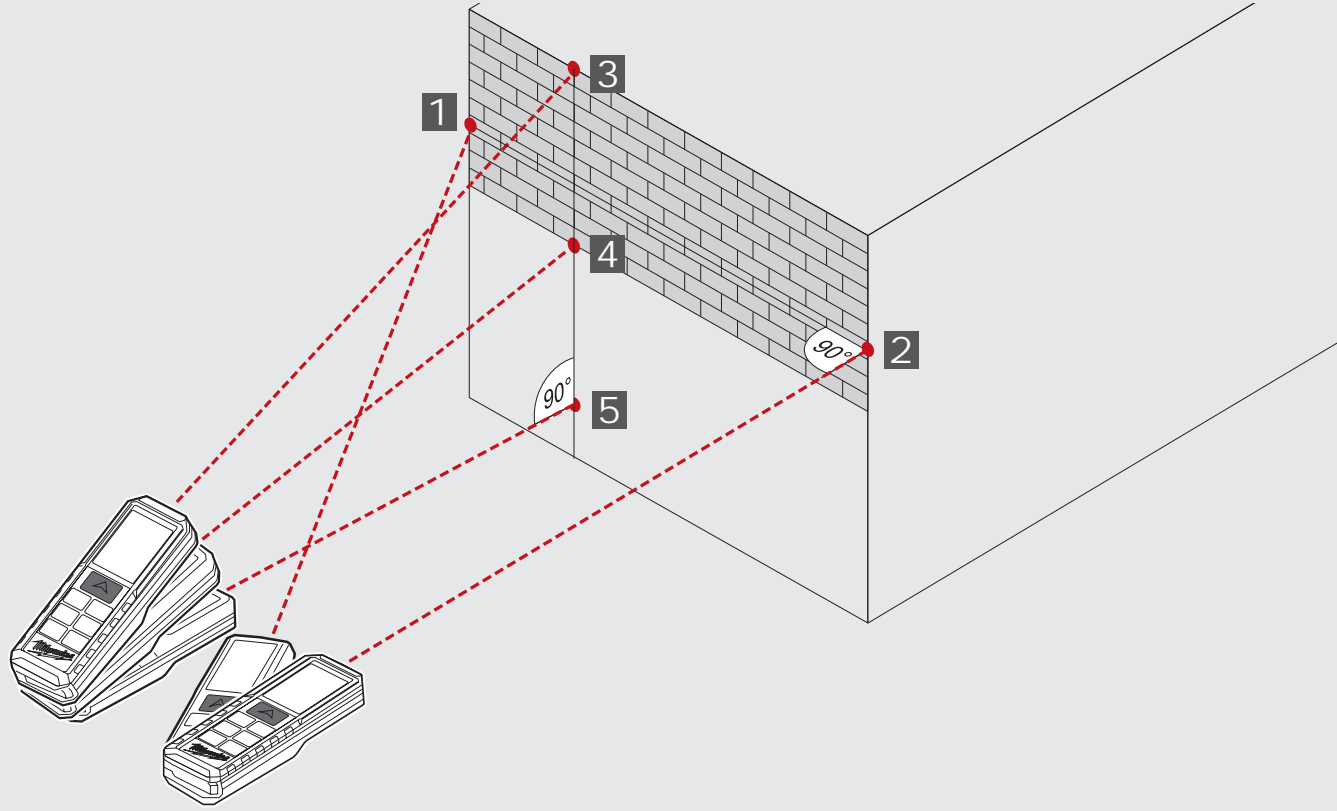
<p>0</p> 	<p>1</p> 	<p>2</p> 	<p>3</p> 	<p>4</p> 
				



5



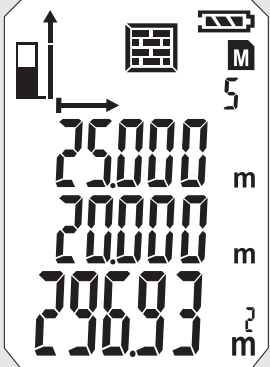



TIMER

Le timer permet de retarder le démarrage de la mesure, par ex. pour placer un composant dans le rayon de mesure.

Actionner la touche 

- Le symbole  sera affiché
- Par l'appui sur la touche  il sera possible de sélectionner le timer entre 3 et 15 sec.

Actionner la touche 

- Le compte à rebours jusqu'à la mesure démarre.
- Au 0, la mesure sera activée.

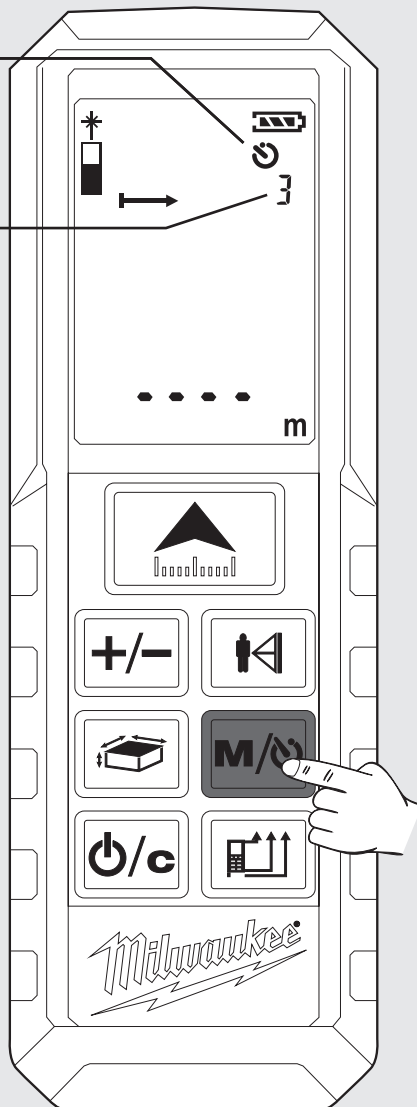

MÉMOIRE

Les valeurs mesurées seront sauvegardées en mémoire automatiquement d'une façon progressive.

Les valeurs mémorisées pourront être sélectionnées par la touche .

Maintenir la touche  enfoncée pendant 2 sec.

- Le symbole et l'espace de mémoire seront affichés.
- Le paramètre de mesure intéressé sera affiché.
- La valeur mémorisée est affichée dans la ligne principale.
- lire les valeurs en mémoire en enfonçant plusieurs fois la touche .

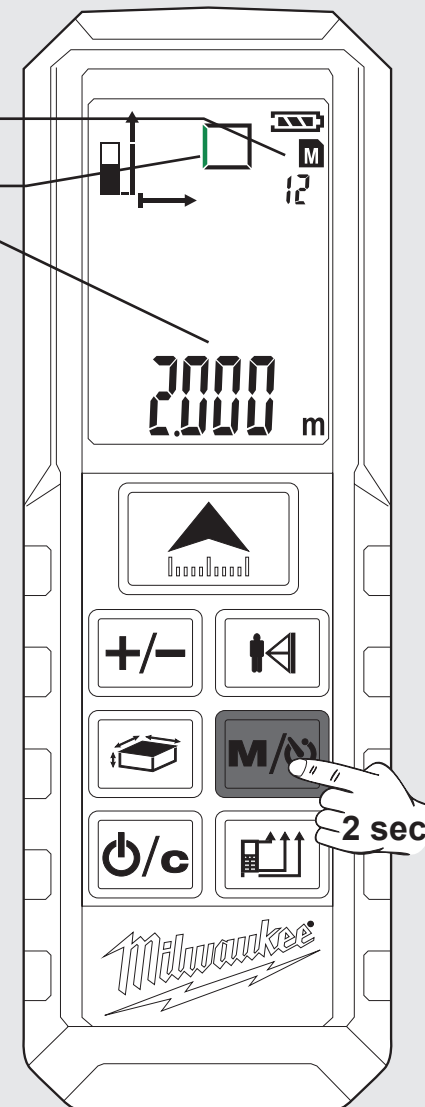

FONCTIONNEMENT DE BASE EXEMPLIFIÉ POUR LA MESURE DE LA SURFACE (1)

1 Activer

Actionner la touche 
⚠ Attention ! Rayon laser on !
 Ne pas diriger sur des personnes !

2 Sélectionner le plan de mesure

Sélection standard à l'activation:
 postérieure

 Enfoncer 1x -> pointe multifonction
 enfoncer 2x -> antérieur
 enfoncer 3x -> postérieur

3 Sélectionner la fonction

A l'activation le dispositif est toujours
 sélectionné sur mesure longueur.

 enfoncer 1x - mesure surface
 - Le symbole est affiché

4 Mesurer la longueur

Orienter le dispositif
 et enfoncer la
 touche 

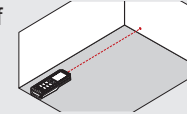

5 Mesure largeur

Orienter le dispositif
 et enfoncer la
 touche 

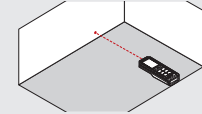

Le symbole laser clignote
 (clignotement indiqué vert).

Le symbole est affiché

- Le paramètre mesuré clignote
 (clignotement indiqué vert)

- La valeur mémorisée est affichée
 brièvement dans la ligne principale.
 - Après 1 sec. la valeur mesurée se
 déplace sur la ligne supérieure.

- La valeur mémorisée est affichée
 brièvement dans la ligne principale.
 - Après 1 sec. la valeur mesurée se
 déplace sur la ligne supérieure.

La valeur mesurée sera mémorisée
 avec un nombre progressif.
 Le second paramètre mesuré
 clignote.
 Le dispositif est prêt à la mesure de
 la seconde valeur.

La valeur mesurée sera mémorisée
 avec un nombre progressif.
 - Le résultat est affiché dans la ligne
 principale et sera sauvegardé en
 mémoire avec un nombre progressif.

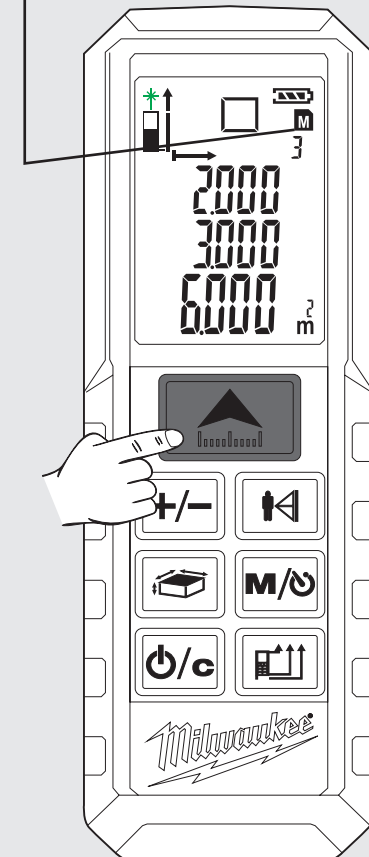
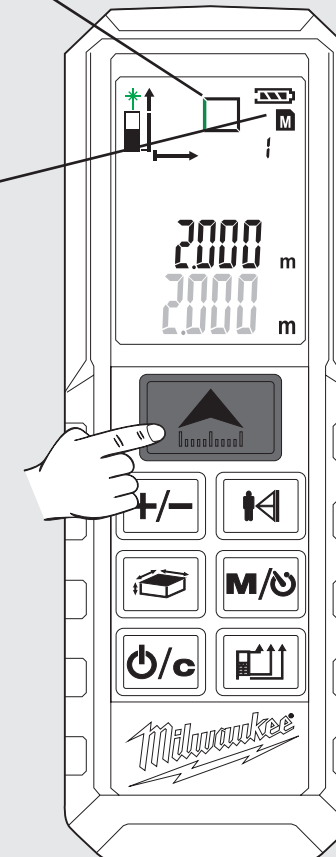
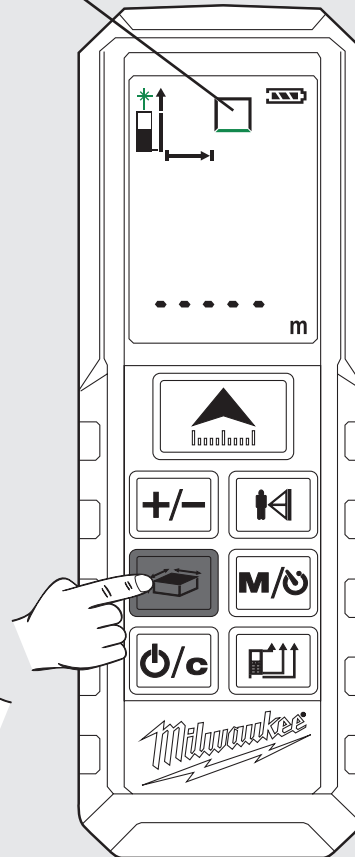
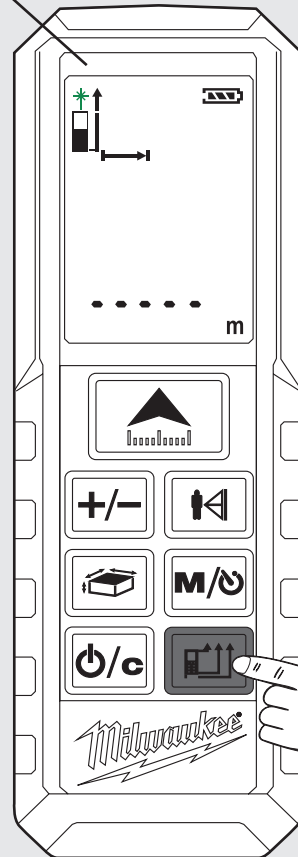
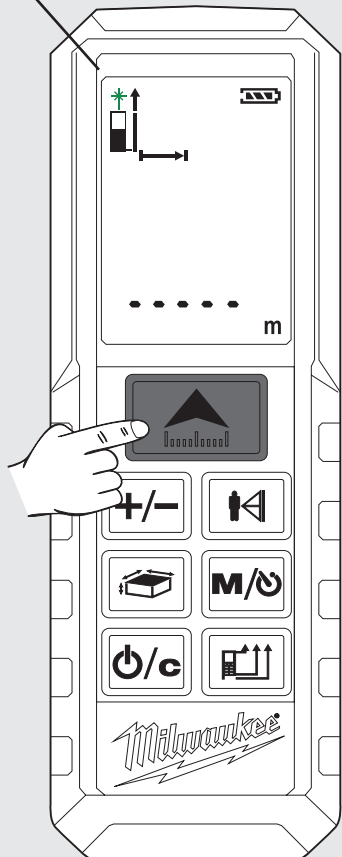

FONCTIONNEMENT DE BASE EXEMPLIFIÉ POUR LA MESURE DE LA SURFACE (2)

6 Sélectionner les valeurs sauvegardées

Maintenir la touche **M/S** enfoncée pendant 2 sec.

Enfoncer plusieurs fois la touche **M/S**.

7 Sortir de la mémoire

Actionner la touche **0/c**

8 Désactiver

Maintenir la touche **0/c** enfoncée pendant 2 sec

(Avant la désactivation, il est nécessaire de sortir de la mémoire).

- Les valeurs mémorisées seront affichées dans la ligne principale.

- Le symbole intéressé sera affiché et le paramètre mesuré clignotera (clignotement indiqué vert).

- Le dispositif se désactive.

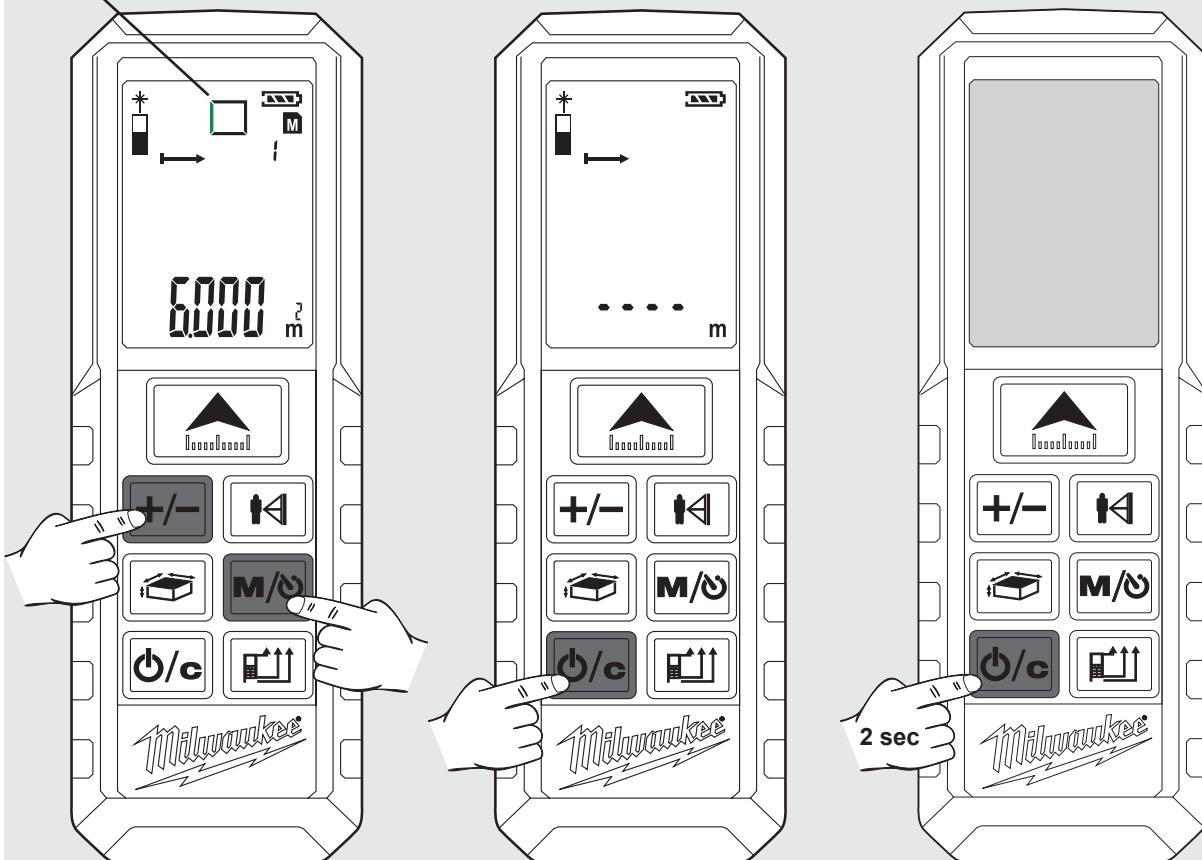

- Si dans les 3 minutes suivantes aucune touche ne sera actionnée, le dispositif se désactivera automatiquement.



INDICE

Importanti istruzioni di sicurezza1
 Dati tecnici2
 Utilizzo conforme2
 Tabella codici errori.....2
 Panoramica3
 Sostituire la batteria.....4
 Perno d'angolo4
 Clip per cinta.....4
 Tasto funzione, Pitagora, piano di misurazione5
 Misurazione lunghezza semplice.....6
 Misurazione continua / misurazione minimo/massimo7
 Misurazione per addizione / sottrazione8
 Misurazione superficie.....9
 Misurazione volume.....10
 Misurazione indiretta (Pitagora 1).....11
 Misurazione indiretta (Pitagora 2).....12
 Misurazione indiretta (Pitagora 3).....13
 Misurazione superficie parete (scenario 1).....14
 Misurazione superficie parete (scenario 2).....15
 Timer16
 Memoria.....16
 Funzionamento di base esemplificato per la misurazione della superficie (1).....17
 Funzionamento di base esemplificato per la misurazione della superficie (2).....18

IMPORTANTI ISTRUZIONI DI SICUREZZA

  Non usare il prodotto prima di avere studiato le Istruzioni di sicurezza e il Manuale d'uso sul CD in allegato.

Classifica laser

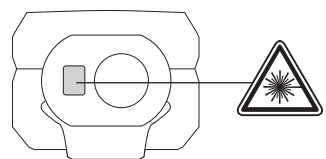

AVVERTENZA:
 Si tratta di un prodotto laser di classe 2 conforme a EN60825-1:2014.



λ 650 nm P<1 mW

Avvertenza:
 Evitare qualsiasi contatto visivo diretto. Il raggio laser può causare un accecamento temporaneo da flash agli occhi.

Non fissare il raggio laser né puntarlo verso altri senza motivo.
 Non abbagliare altre persone.

Avvertenza:
 Non usare il dispositivo a laser nelle vicinanze di bambini e non permettere ai bambini di usare il dispositivo a laser.

Attenzione! Superfici riflettenti potrebbero fare riflettere il raggio laser sull'operatore o su altre persone.

Tenere le estremità a una distanza di sicurezza.
 Effettuare periodicamente delle misure di controllo, soprattutto prima, durante e dopo misurazioni di particolare importanza.

Se il prodotto è difettoso, è caduto, è stato usato in modo improprio o modificato potrebbe fornire misurazioni errate.

Avvertenza: L'uso di elementi di controllo, di impostazioni oppure l'esecuzione di procedimenti diversi da quelli stabiliti nel manuale può comportare una pericolosa esposizione ai raggi.

Il dispositivo di misura a laser ha un range di applicazione limitato. (Vedi il capitolo "Dati tecnici"). Tentativi di misurare al di fuori del range massimo e minimo causano imprecisioni. L'uso in presenza di condizioni atmosferiche avverse, come temperature eccessivamente alte o basse, luce solare molto intensa, pioggia, neve, nebbia o altre condizioni che limitano la visibilità, può comportare misurazioni imprecise.

Se il dispositivo di misura a laser viene portato da un ambiente caldo in un ambiente freddo (o vice-versa), attendere che il dispositivo si adatti alla nuova temperatura ambiente.

Conservare il dispositivo di misura a laser sempre in ambienti chiusi, proteggerlo da urti, vibrazioni e temperature estreme.

Proteggere il dispositivo di misura a laser da polveri, liquidi ed elevata umidità dell'aria. I suddetti fattori potrebbero danneggiare gravemente i componenti interni o influenzare negativamente la precisione.

Non usare detergenti aggressivi o solventi. Pulire soltanto con un panno pulito, morbido.

Evitare forti urti sul dispositivo di misura a laser o la sua caduta. Dopo una caduta del dispositivo di misura a laser o dopo una sua esposizione ad altre sollecitazioni meccaniche è necessario verificare la precisione del dispositivo.

Le riparazioni eventualmente necessarie sul dispositivo a laser devono essere eseguite esclusivamente da personale specializzato autorizzato!

Non azionare il prodotto in aree a rischio di esplosione o in ambienti aggressivi.

Utilizzare solo cariche batterie raccomandati dal produttore.

 I rifiuti di pile e i rifiuti di apparecchiature elettriche ed elettroniche non devono essere smaltiti insieme ai rifiuti domestici. I rifiuti di pile e di apparecchiature elettriche ed elettroniche devono essere raccolti e smaltiti separatamente.

Rimuovere i rifiuti di pile e di accumulatori nonché le sorgenti luminose dalle apparecchiature prima di smaltirle.

Chiedere alle autorità locali o al rivenditore specializzato dove si trovano i centri di riciclaggio e i punti di raccolta.

A seconda dei regolamenti locali, i rivenditori al dettaglio possono essere obbligati a ritirare gratuitamente i rifiuti di pile e i rifiuti di apparecchiature elettriche ed elettroniche.

Aiutate a ridurre il fabbisogno di materie prime riutilizzando e riciclando i propri rifiuti di pile e di apparecchiature elettriche ed elettroniche.

I rifiuti di pile (specialmente di pile agli ioni di litio) e i rifiuti di apparecchiature elettriche ed elettroniche contengono materiali preziosi e riciclabili che possono avere un impatto negativo sull'ambiente e sulla vostra salute se non vengono smaltiti in modo ecologico.

Cancellare tutti i dati personali che potrebbero essere presenti sul vostro rifiuto di apparecchiatura prima di procedere allo smaltimento.

 Marchio di conformità europea

 Marchio di conformità britannico

 Marchio di conformità ucraino

 Marchio di conformità euroasiatico



DATI TECNICI

Classe di protezione	IP54 (protezione da polveri e spruzzi d'acqua)
Ottica	14 mm
Punto focale	35 mm
Range di misurazione max.	50 metri (tolleranza: 55m)
Range di misurazione min.	0,05 metri
Precisione assoluta @ < 10m	± 1,5 mm (max)
Precisione di ripetibilità @ < 10m	± 1,5 mm (tipicamente max. 2σ)
Precisione di ripetibilità @ > 10m	salita ± 0,25 mm / metro (tipicamente max. 2σ)
Tempo di misurazione	0,5 s
Display tipo	LCD (22,7 mm x 31 mm)
Alimentazione	AAA 2x (batteria alcalina)
Durata batteria	10000 (misurazione singola)
Potenza di uscita laser	0,6 mW ~ 0,95 mW (Class 2, 650nm)
Dimensione punto laser	25 x 30 mm @ 16 m (max)
Classe laser	2
Tipo laser	650 nm, < 1 mW
Raggio laser angolo verticale	+1 grado
Raggio laser angolo orizzontale	±1 grado
Disattivazione automatica dispositivo	180 secondi
Disattivazione automatica laser	30 secondi
Range temperatura di lavoro	da -10°C a +50°C
Range temperatura di immagazzinaggio	da -25°C a +70°C
Peso senza batteria	80 g

UTILIZZO CONFORME

Il dispositivo di misura a laser è atto a misurare distanze ed inclinazioni.

Utilizzare il prodotto solo per l'uso per cui è previsto.

TABELLA CODICI ERRORI

Codice	Descrizione	Soluzione
Err01	Fuori range di misurazione	Misurare nel range previsto.
Err02	Segnale riflesso troppo debole	Scegliere una superficie più idonea.
Err03	Fuori range di visualizzazione (valore max: 99.999) è ad esempio il risultato di una superficie o volume al di fuori del range di visualizzazione	Verificare se i valori ed i passi sono corretti.
Err04	Errore nel calcolo di Pitagora	Verificare se i valori ed i passi sono corretti.
Err05	Batteria scarica	Sostituire le batterie.
Err06	Fuori range della temperatura di lavoro	Eseguire la misurazione nel range previsto per la temperatura di lavoro.
Err07	Eccessiva luce ambiente	Oscurare l'area target.

Pitagora
Differenza altezza

Piano di misurazione

Misurazione lunghezza

Minimo / massimo per misurazione continua

Addizione / sottrazione

ON / MISURARE

- ▶ ON
- ▶ Misurare
- ▶ Misurazione continua (premere per 2 sec)
Funzione min. / max.

ADDIZIONE / SOTTRAZIONE

- ▶ Addizione valore
- ▶ Navigazione memoria

SUPERFICIE / VOLUME

- ▶ Superficie (premere 1x)
- ▶ Volume (premere 2x)
- ▶ Misurazione indiretta della superficie (premere 3x / 4x)

ATTIVARE

- ▶ ON
- ▶ Off (premere per 2 sec)
- ▶ Reset

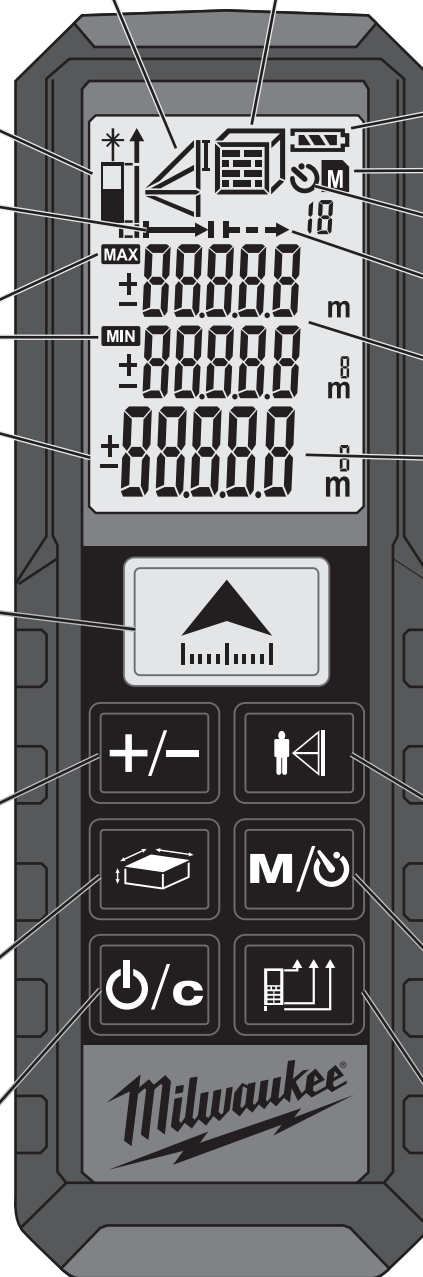

Superficie / volume
Misurazione indiretta della superficie

Livello batteria

Memoria

Timer

Misurazione continua

Valori intermedi

Valore complessivo

PITAGORA

- ▶ Pitagora 1 (premere 1x)
- ▶ Pitagora 2 (premere 2x)
- ▶ Pitagora 3 (premere 3x)

MEMORIA

- ▶ Timer 3-15 sec. (premere 1x)
- ▶ Memoria 1-20 (premere 1x 2 sec.)
- ▶ Leggi valori in memoria (premere ripetutamente)

CAMBIA PIANO DI MISURAZIONE

- ▶ Anteriore
- ▶ Posteriore
- ▶ Perno d'angolo

SOSTITUIRE LA BATTERIA

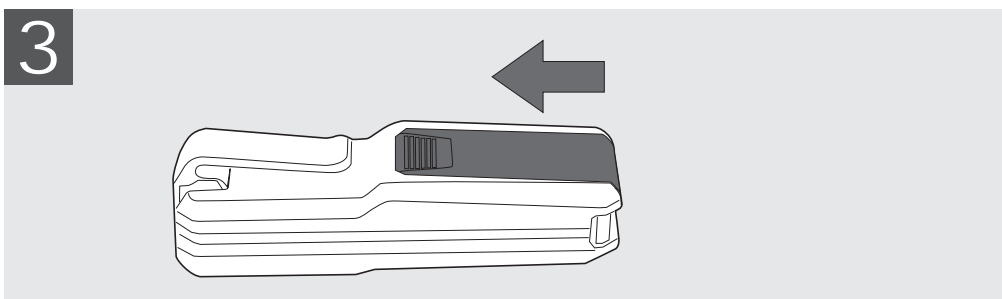
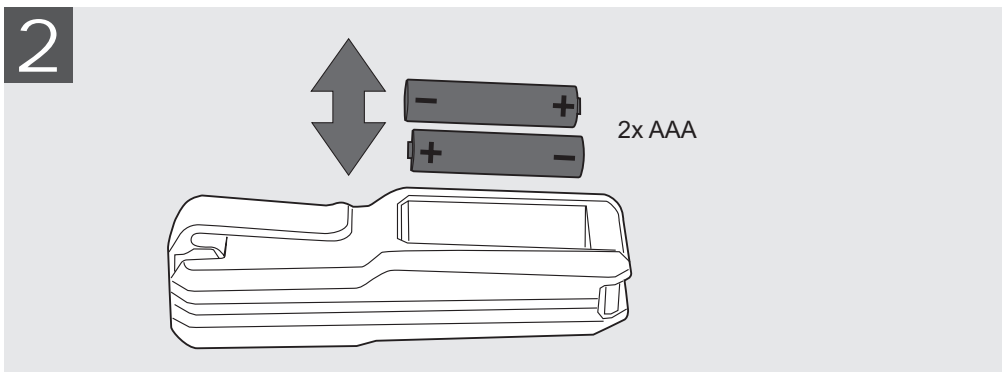
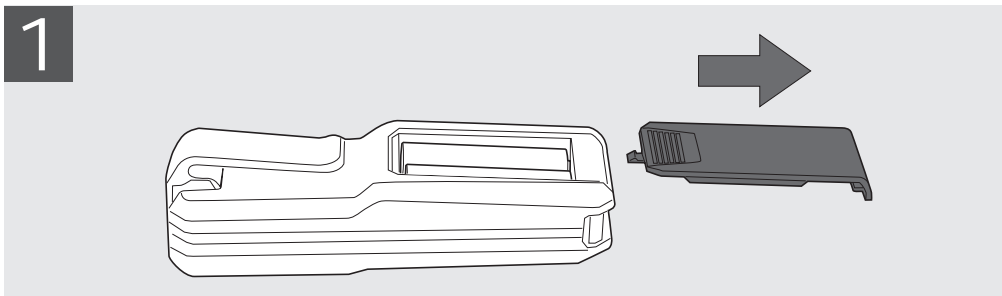
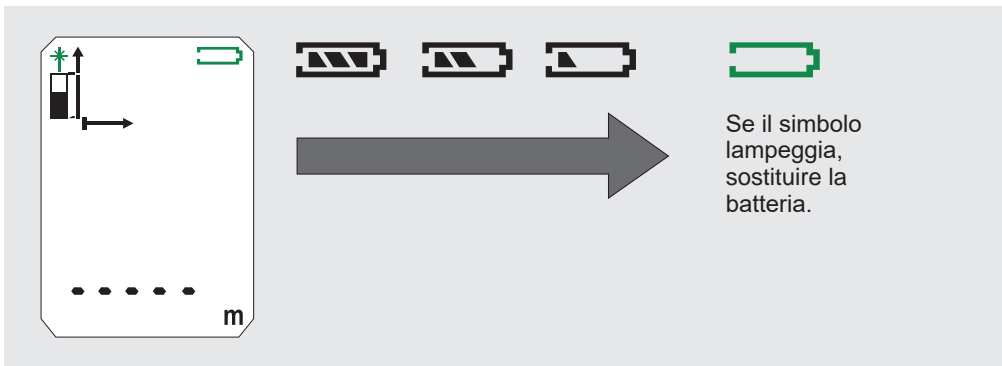

PERNO D'ANGOLO

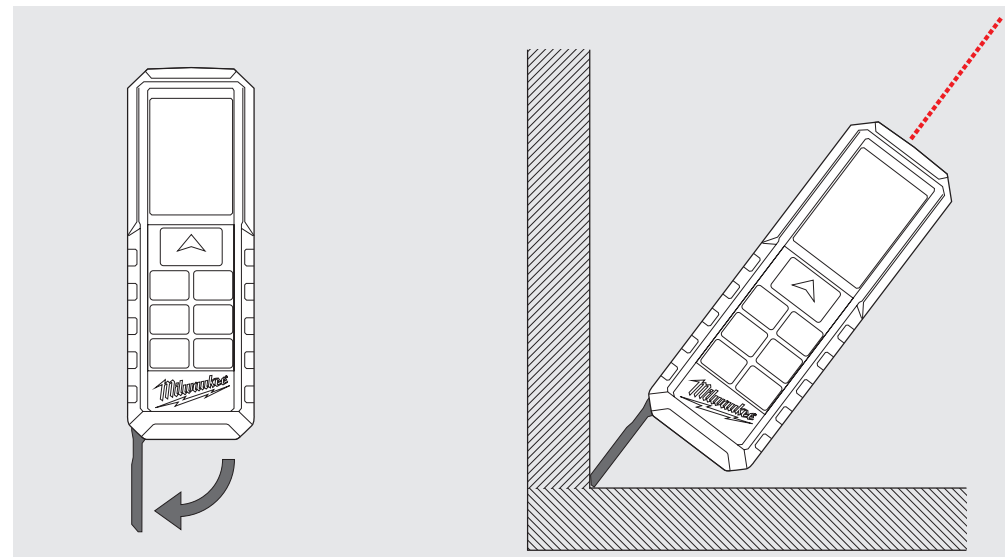

CLIP PER CINTA

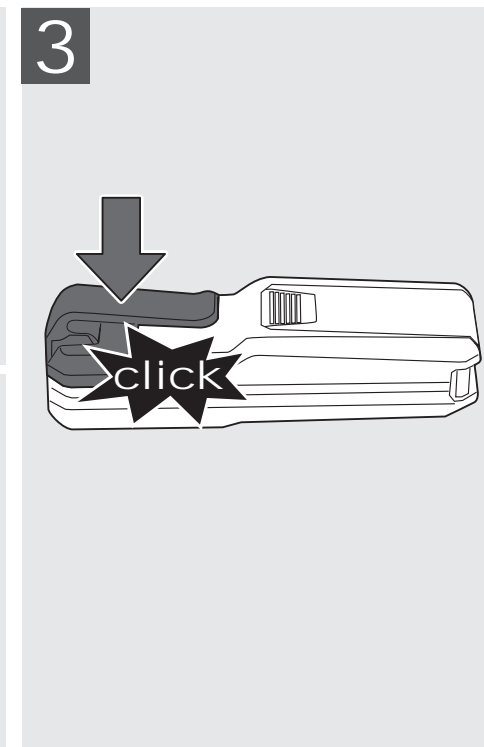
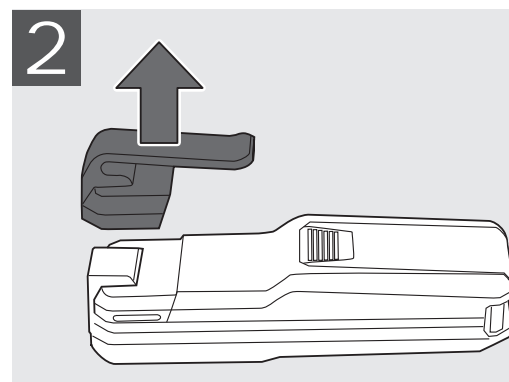
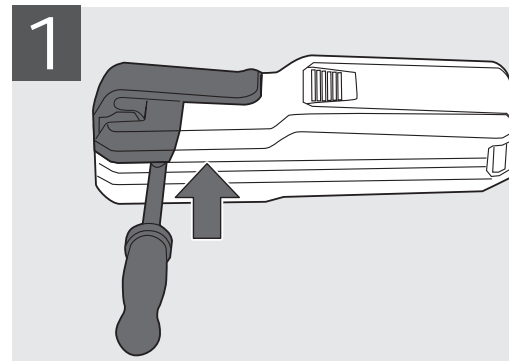

TASTO FUNZIONE, PITAGORA, PIANO DI MISURAZIONE

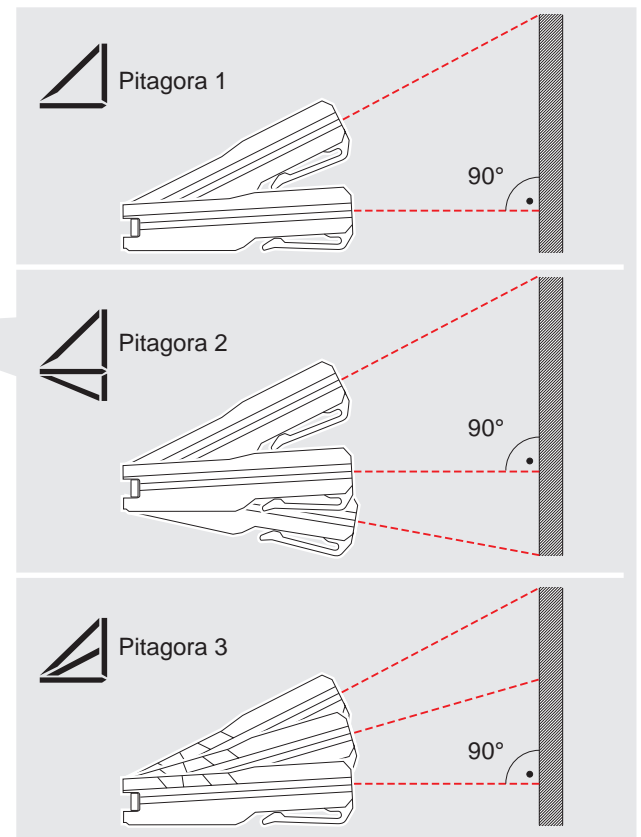
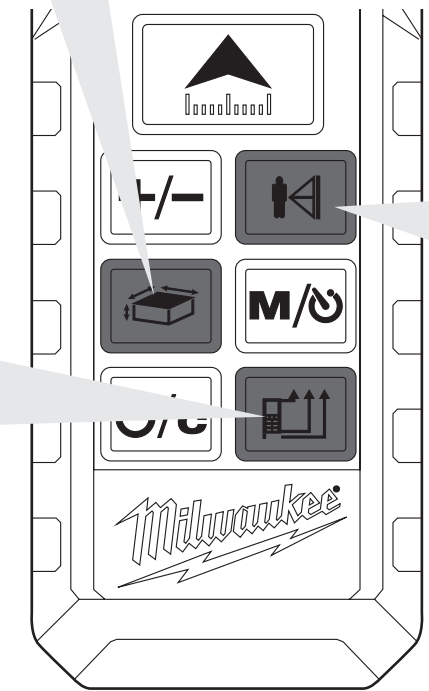
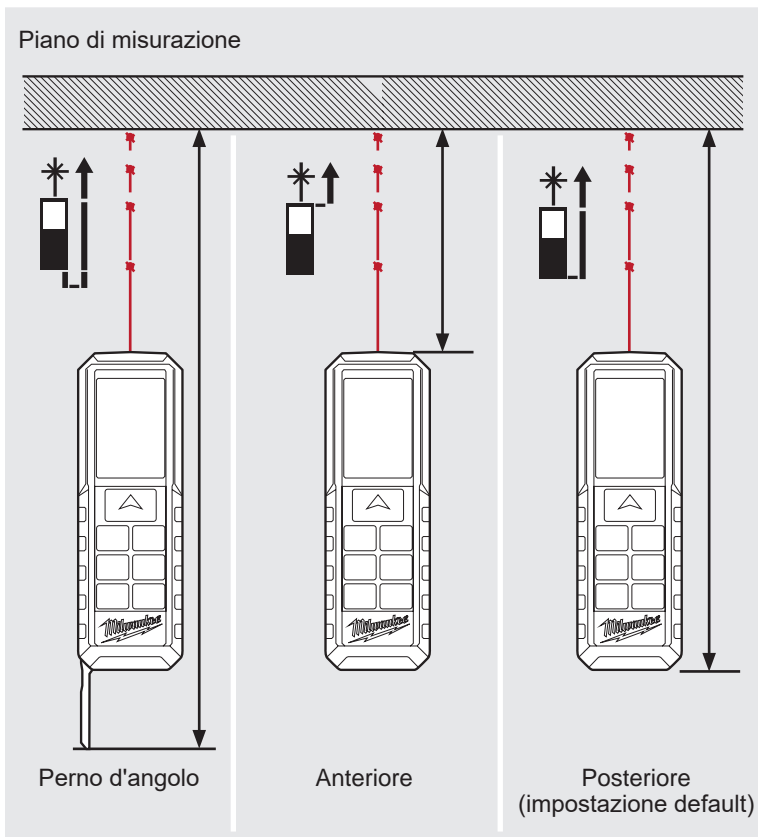
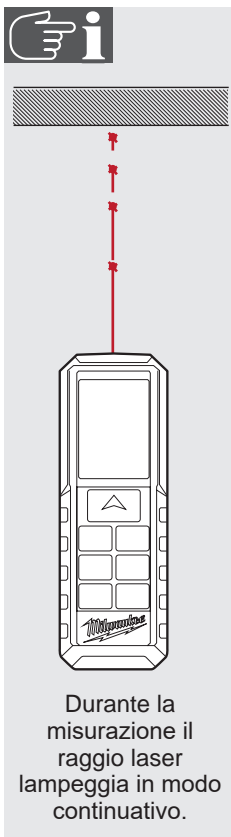
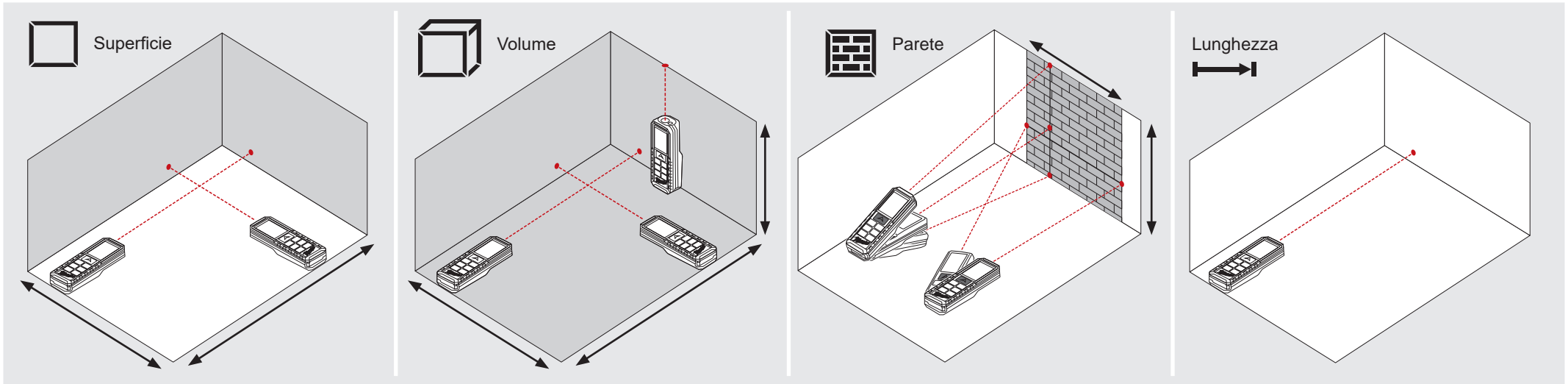

MISURAZIONE LUNGHEZZA SEMPLICE

0

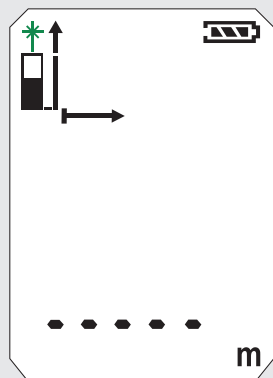

1

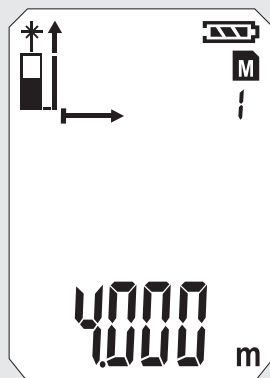

2

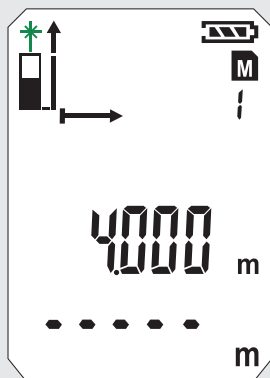

3

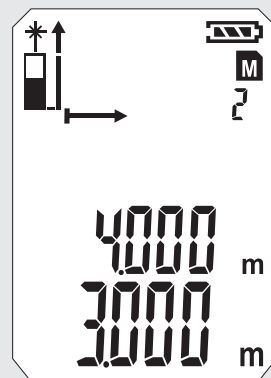

4

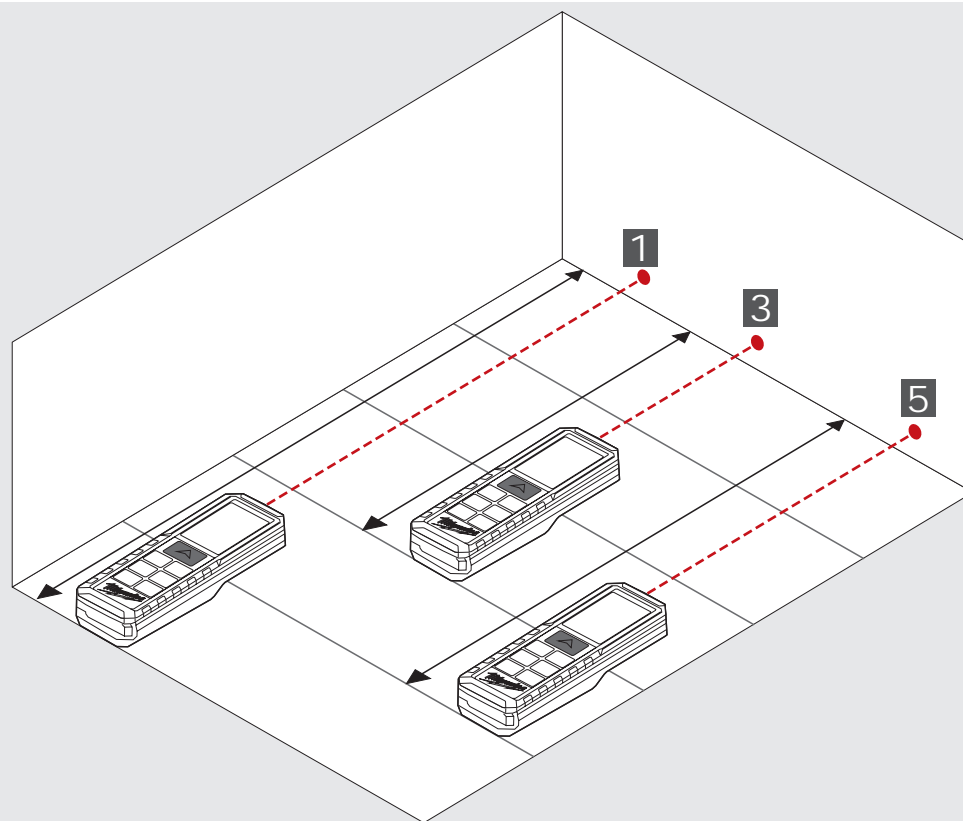
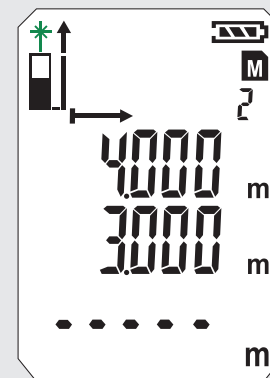

5

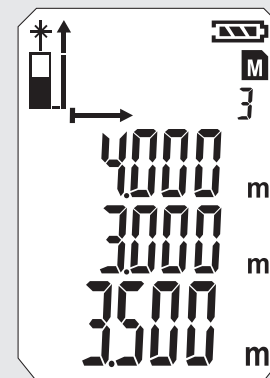

MISURAZIONE CONTINUA / MISURAZIONE MINIMO/MASSIMO

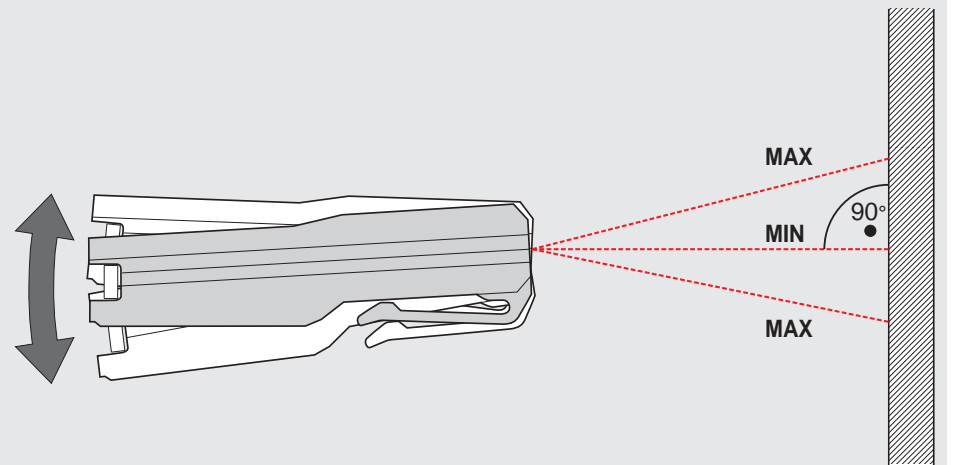
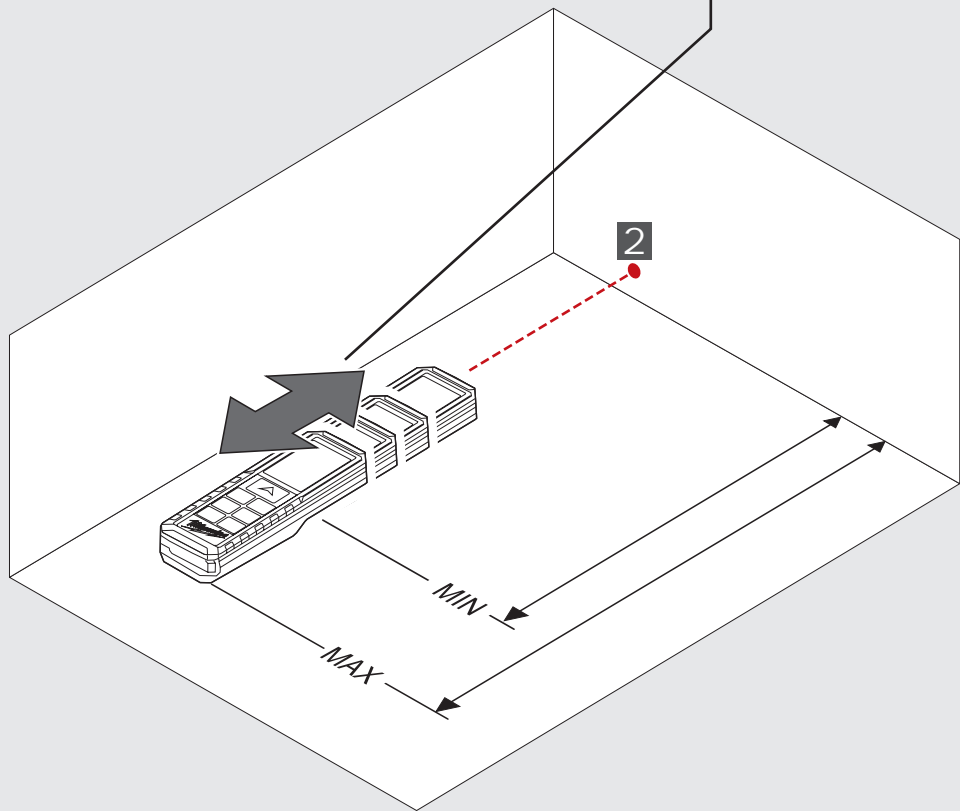
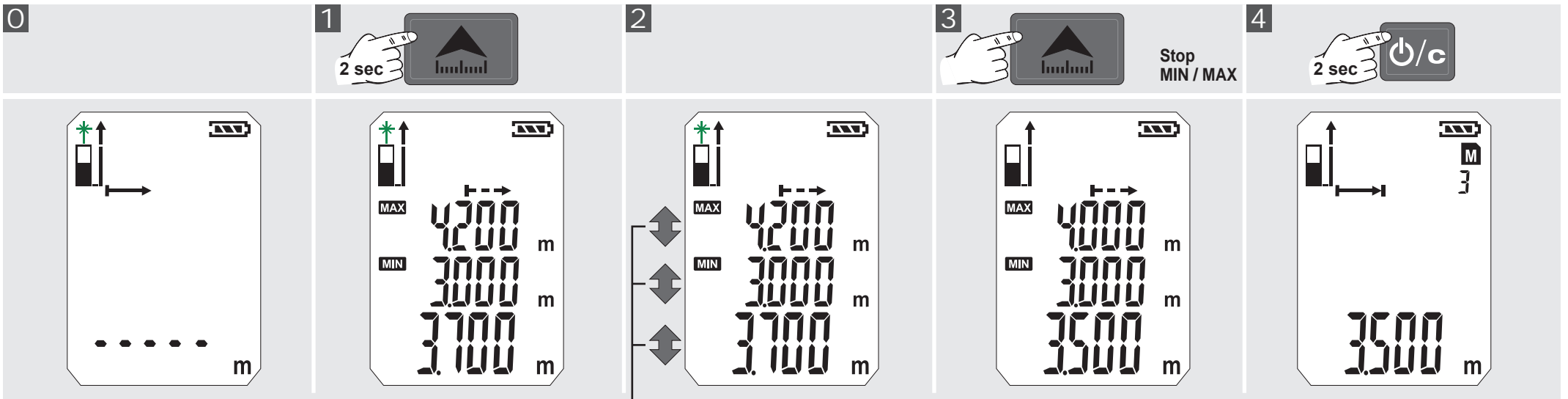

0

1

2

3

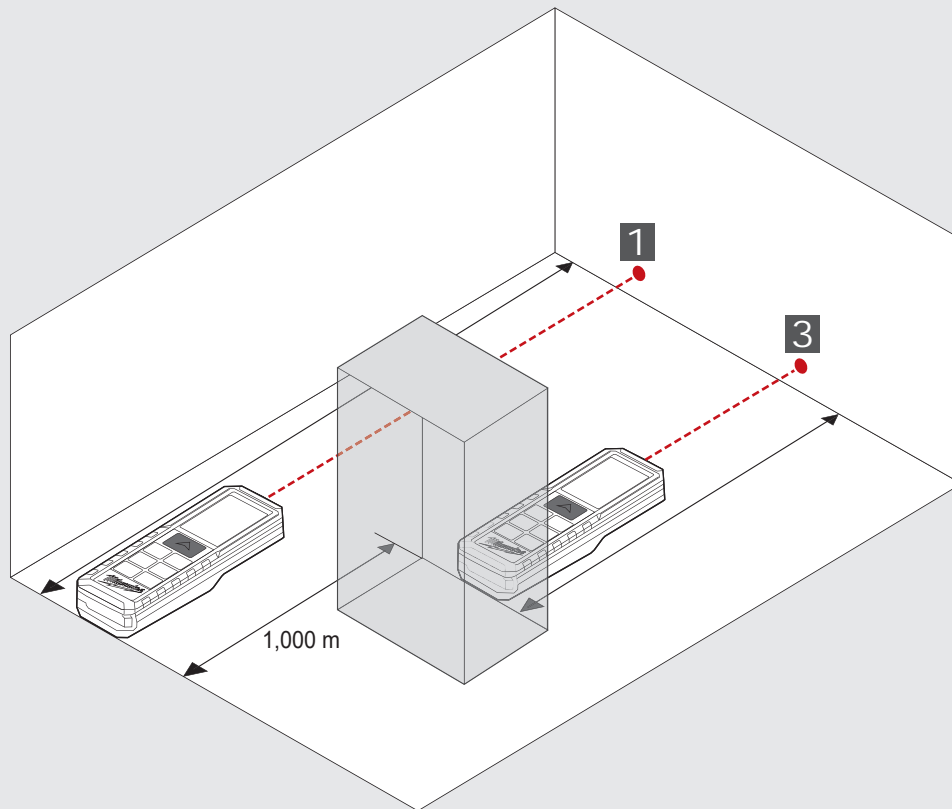
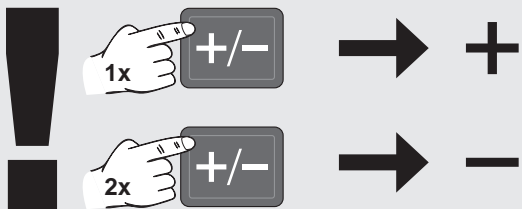
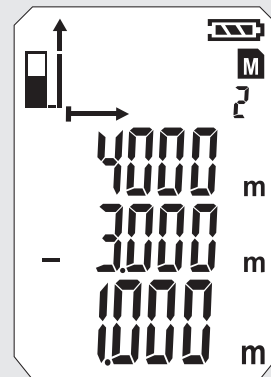
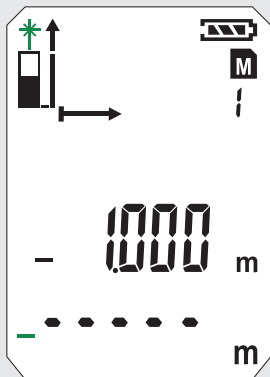
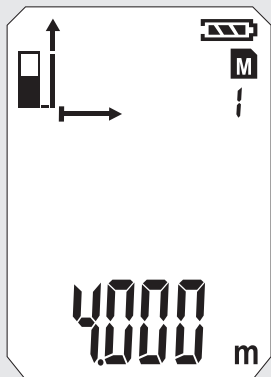
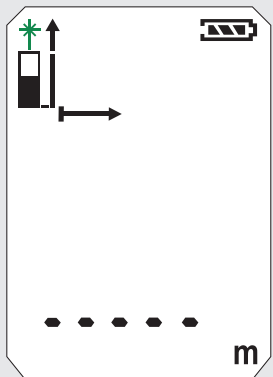

MISURAZIONE SUPERFICIE

0



1



2

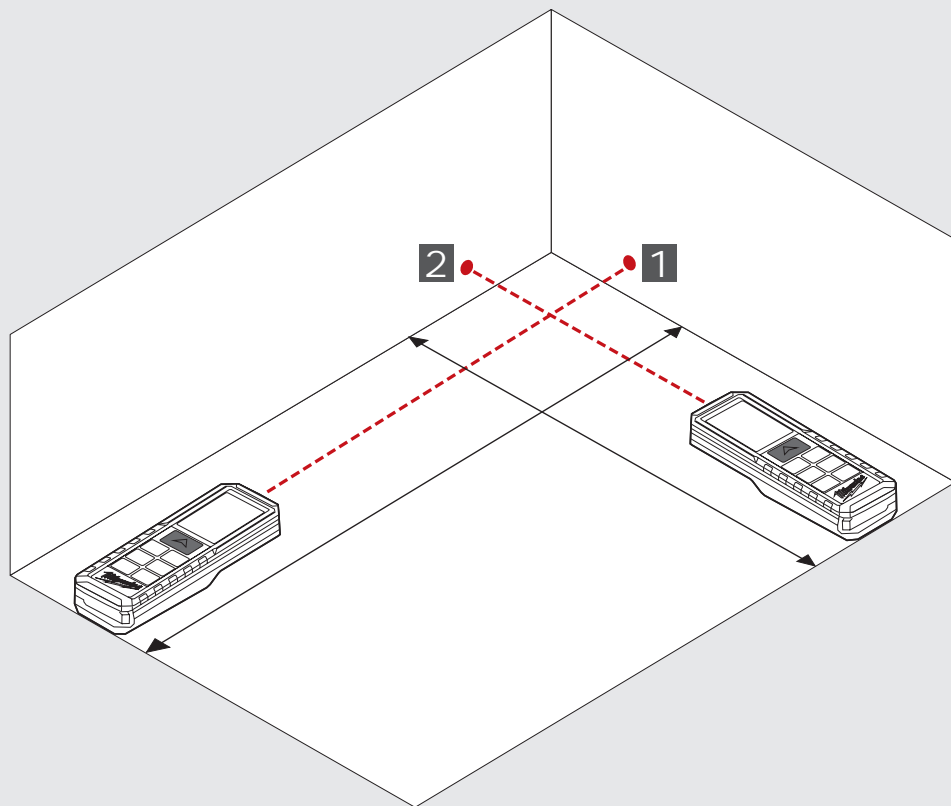
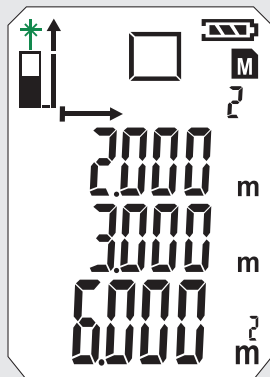
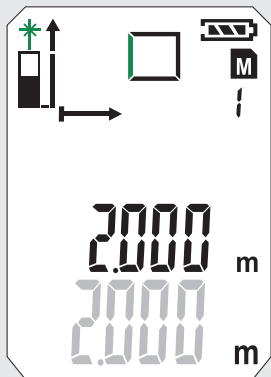
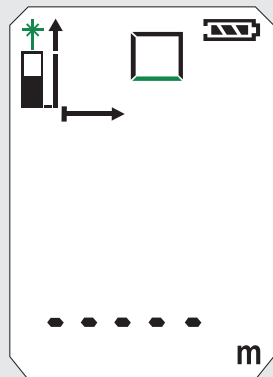

MISURAZIONE VOLUME

0



1



2



3

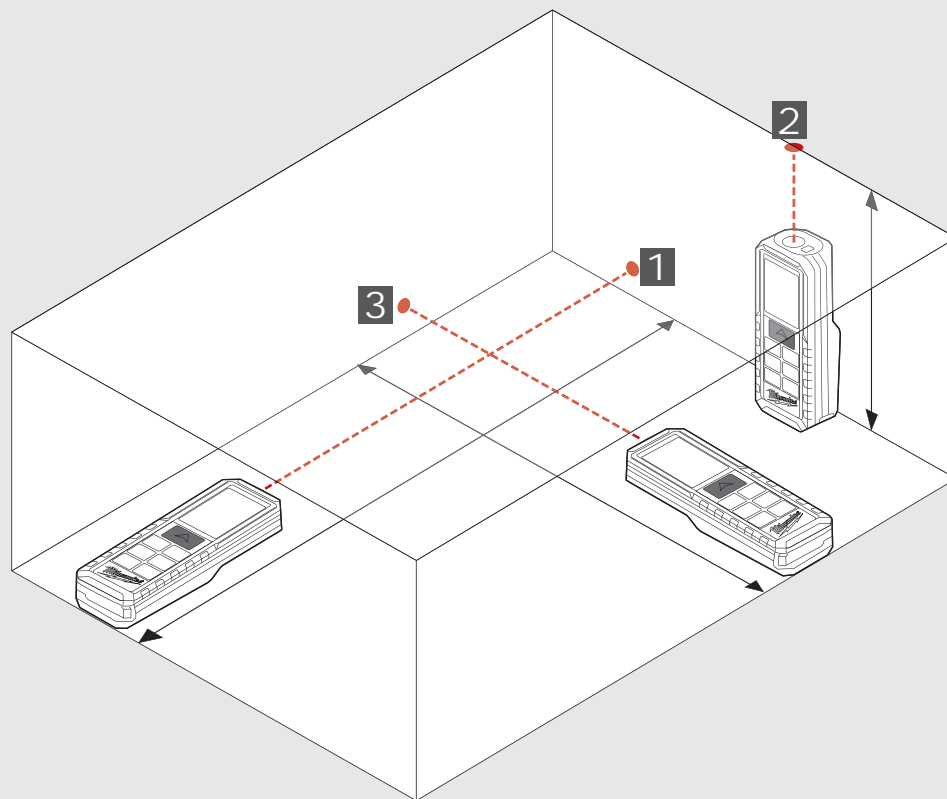
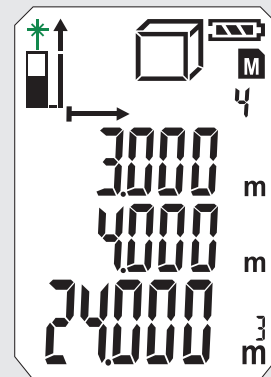
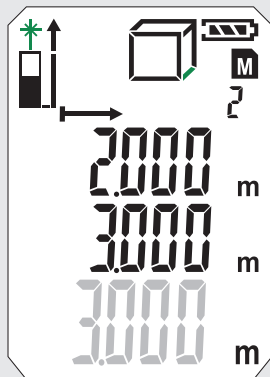
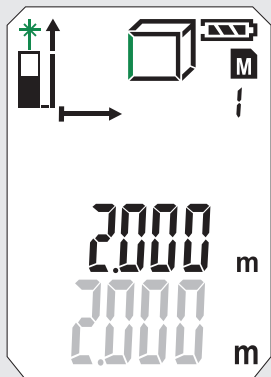
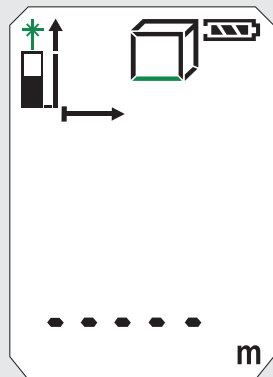

MISURAZIONE INDIRETTA (PITAGORA 1)

0



1 x

1



2

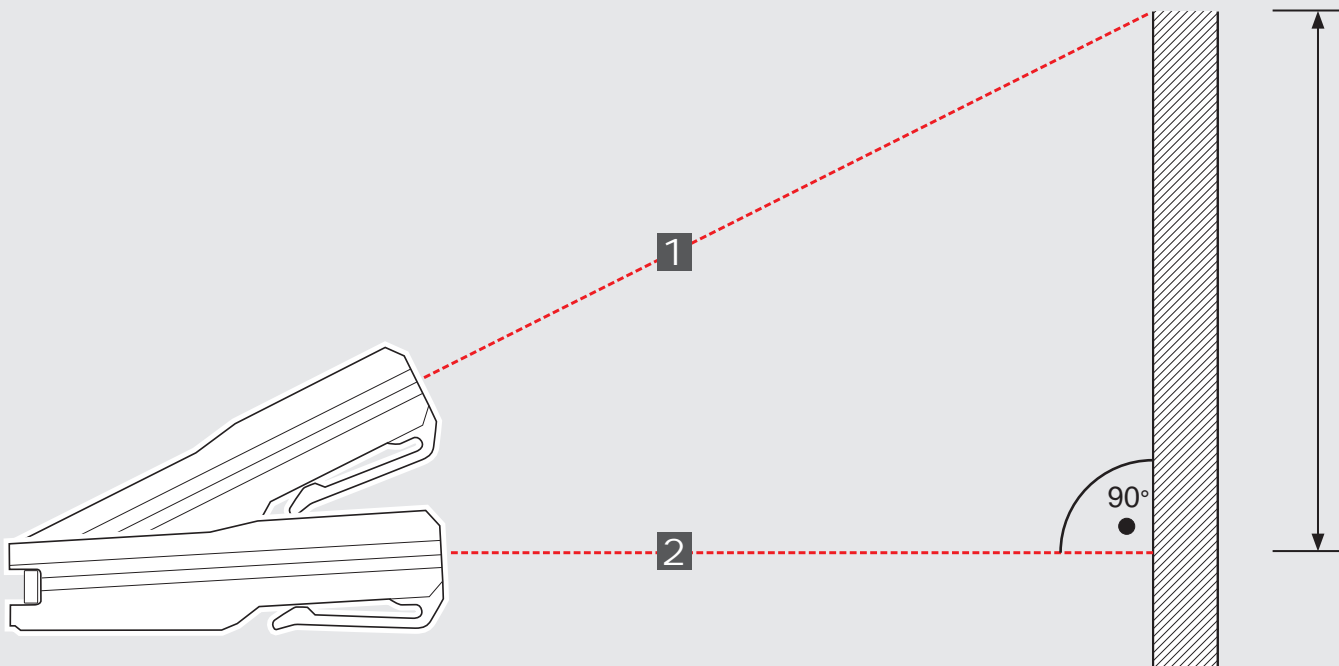
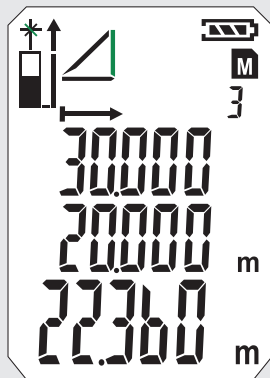
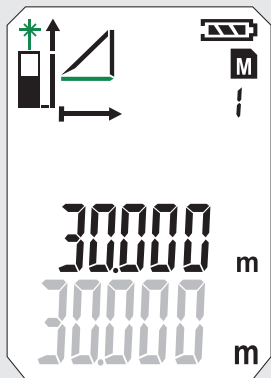
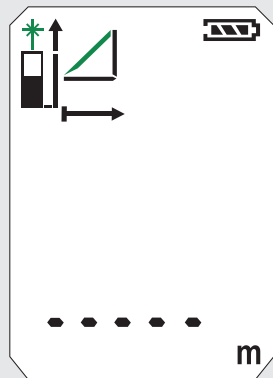

MISURAZIONE INDIRETTA (PITAGORA 2)

0

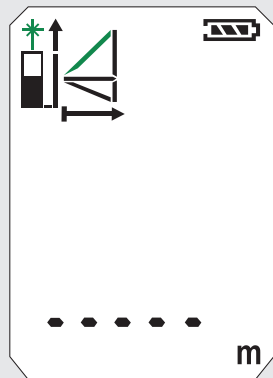

1

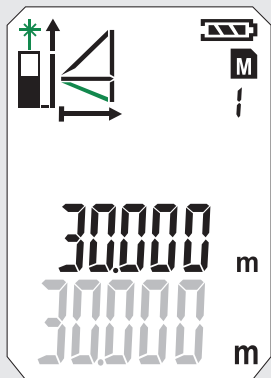



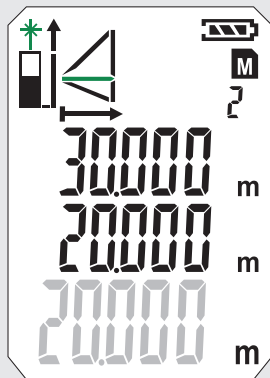

2

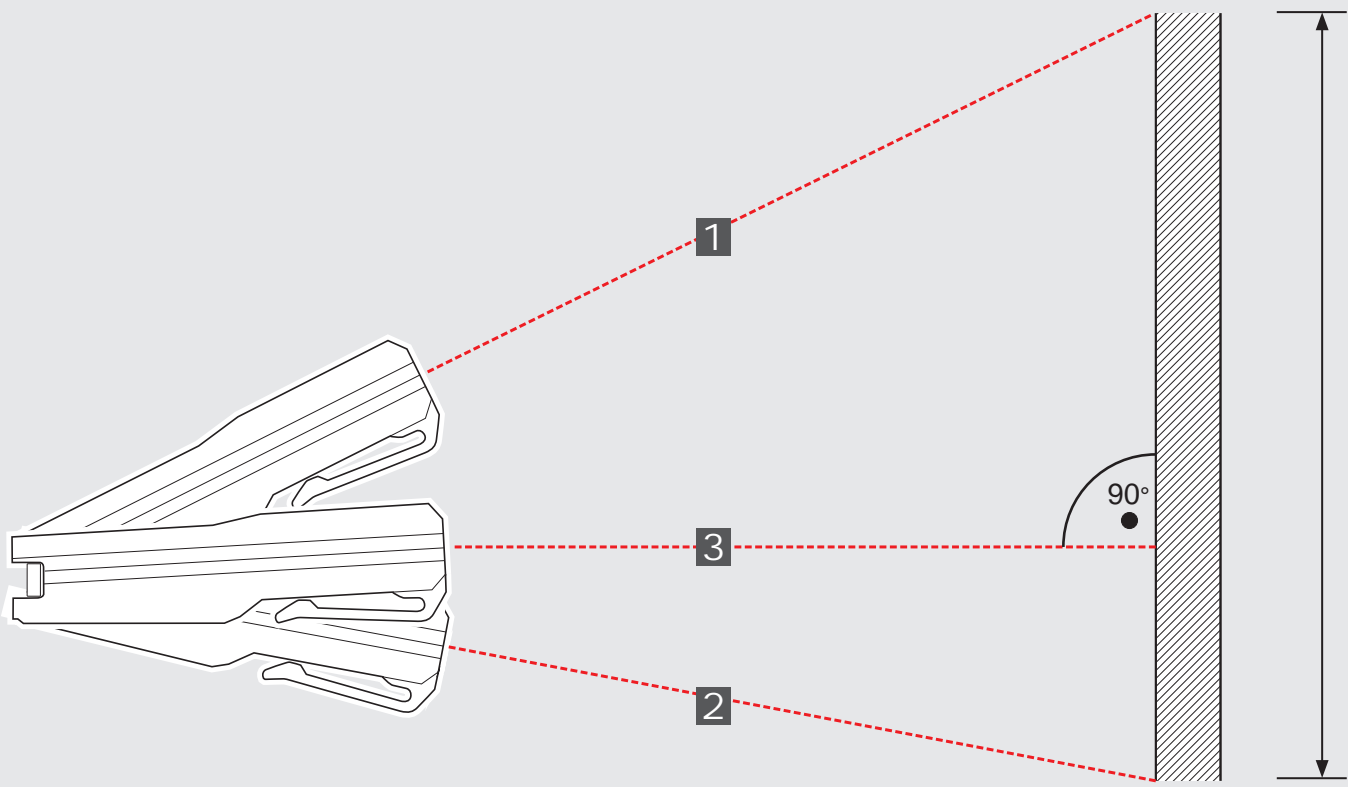
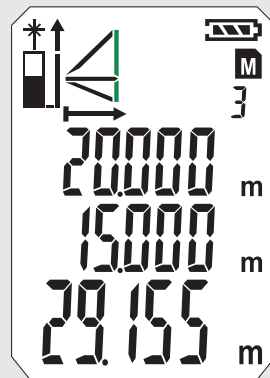

3





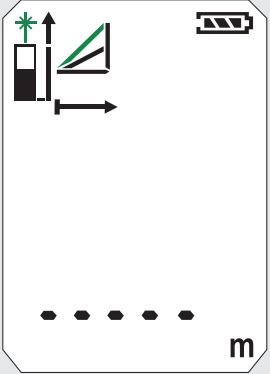
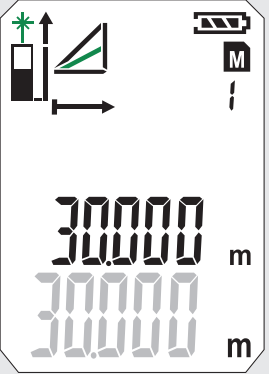
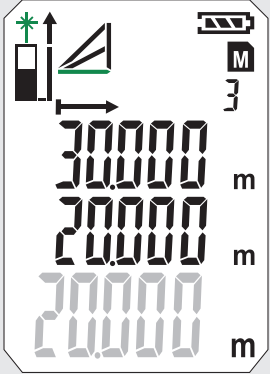
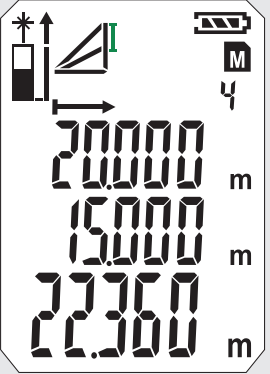

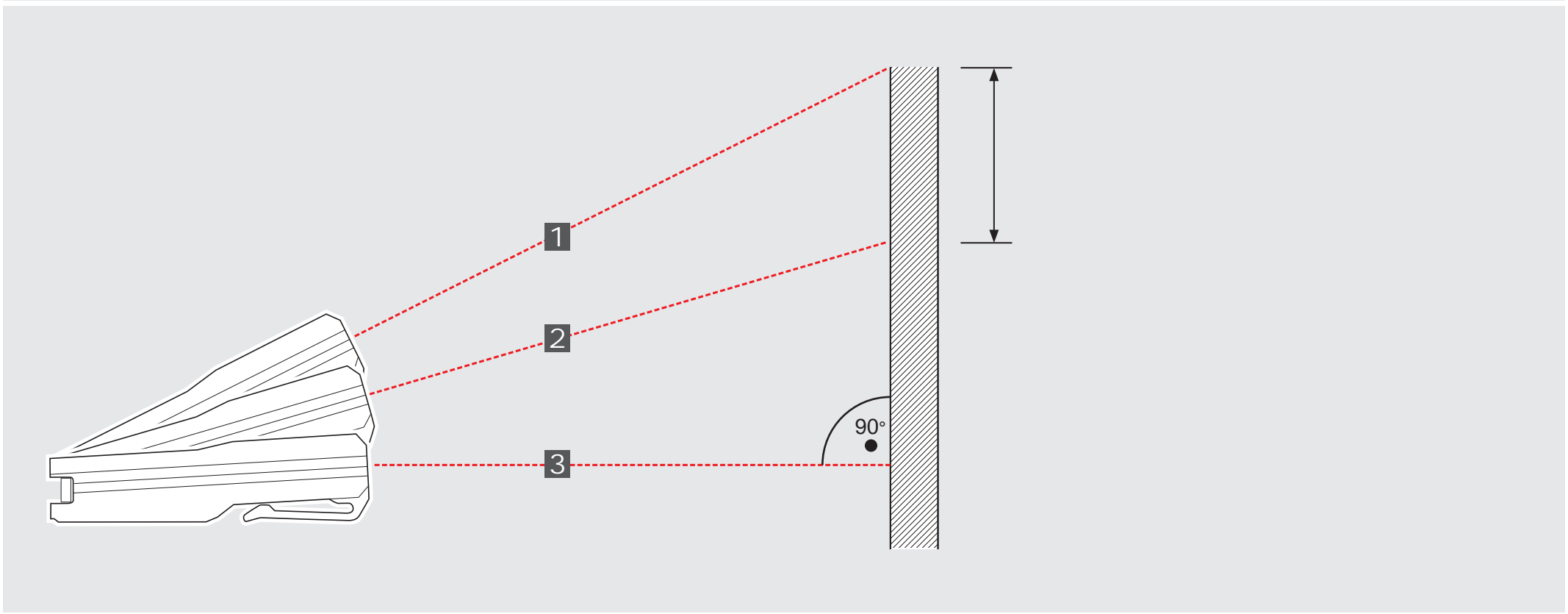

MISURAZIONE INDIRECTA (PITAGORA 3)

1 	2 	3 	4 
			

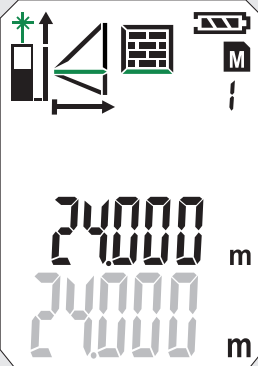
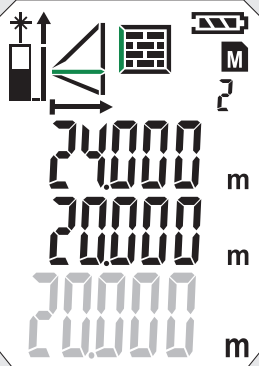
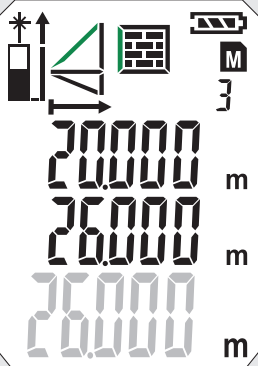
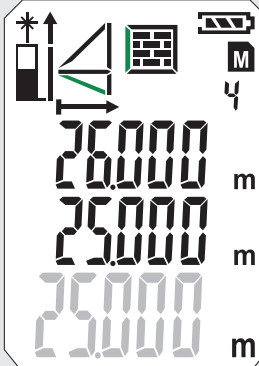

MISURAZIONE SUPERFICIE PARETE (SCENARIO 1)

<p>0</p> 	<p>1</p> 	<p>2</p> 	<p>3</p> 	<p>4</p> 
				

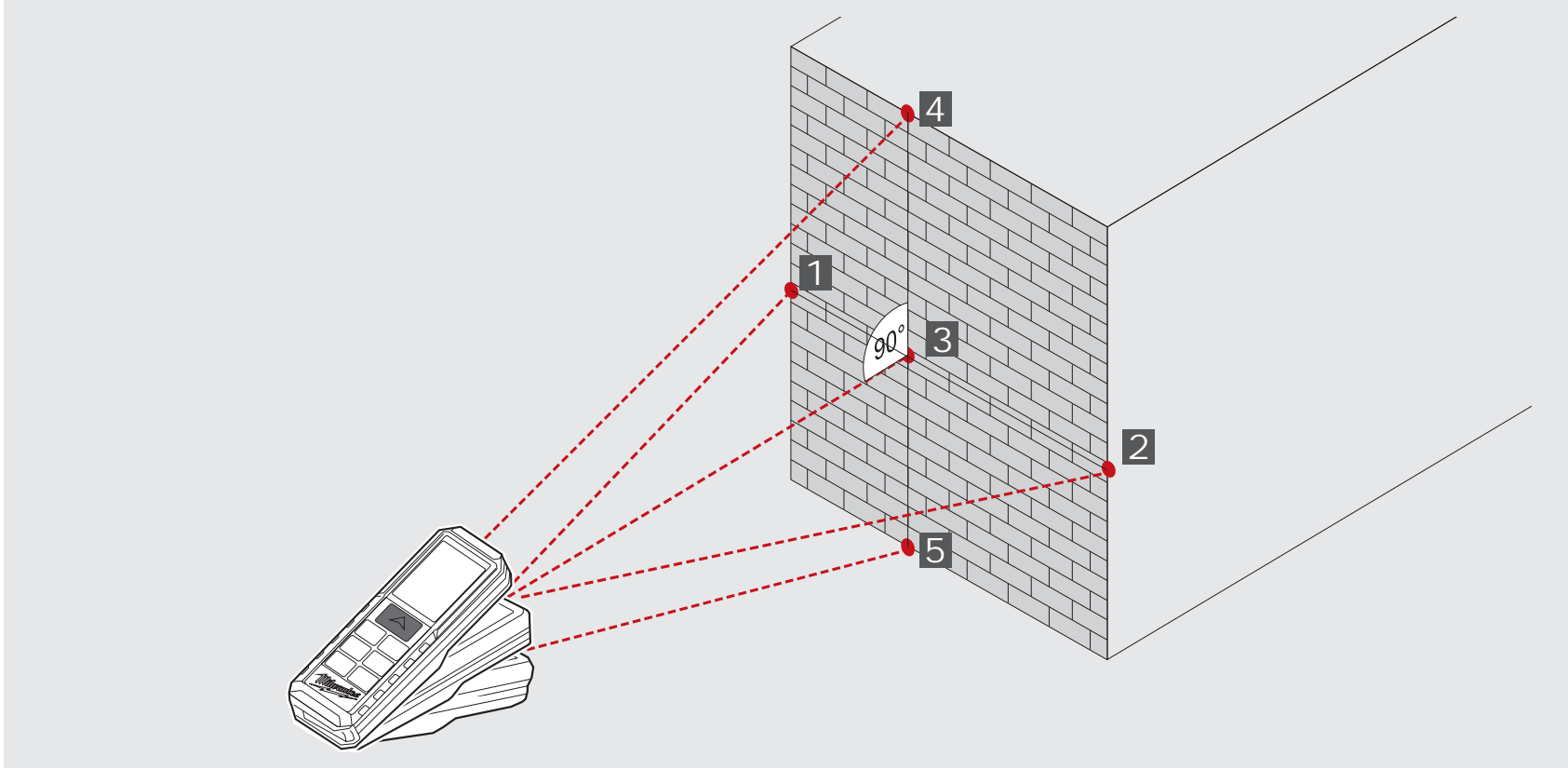



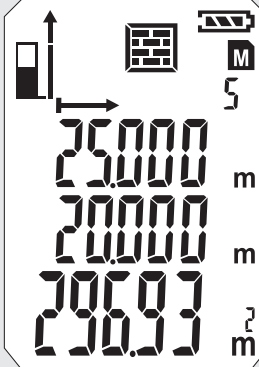

5



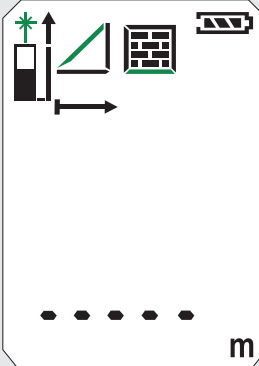
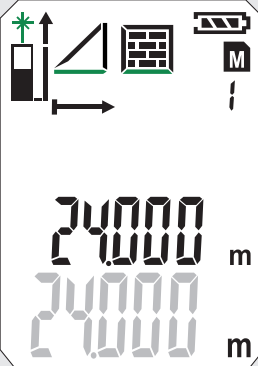
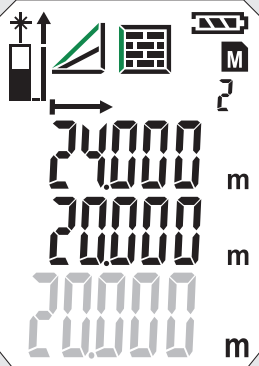
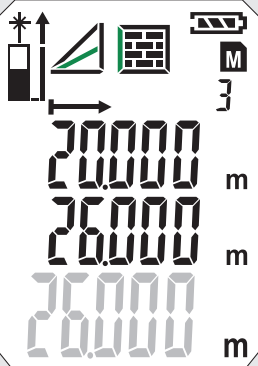
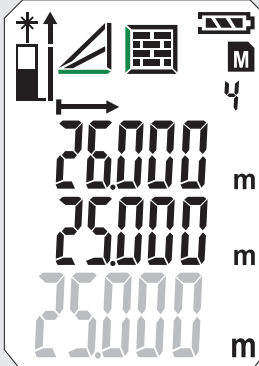

MISURAZIONE SUPERFICIE PARETE (SCENARIO 2)

<p>0</p> 	<p>1</p> 	<p>2</p> 	<p>3</p> 	<p>4</p> 
				

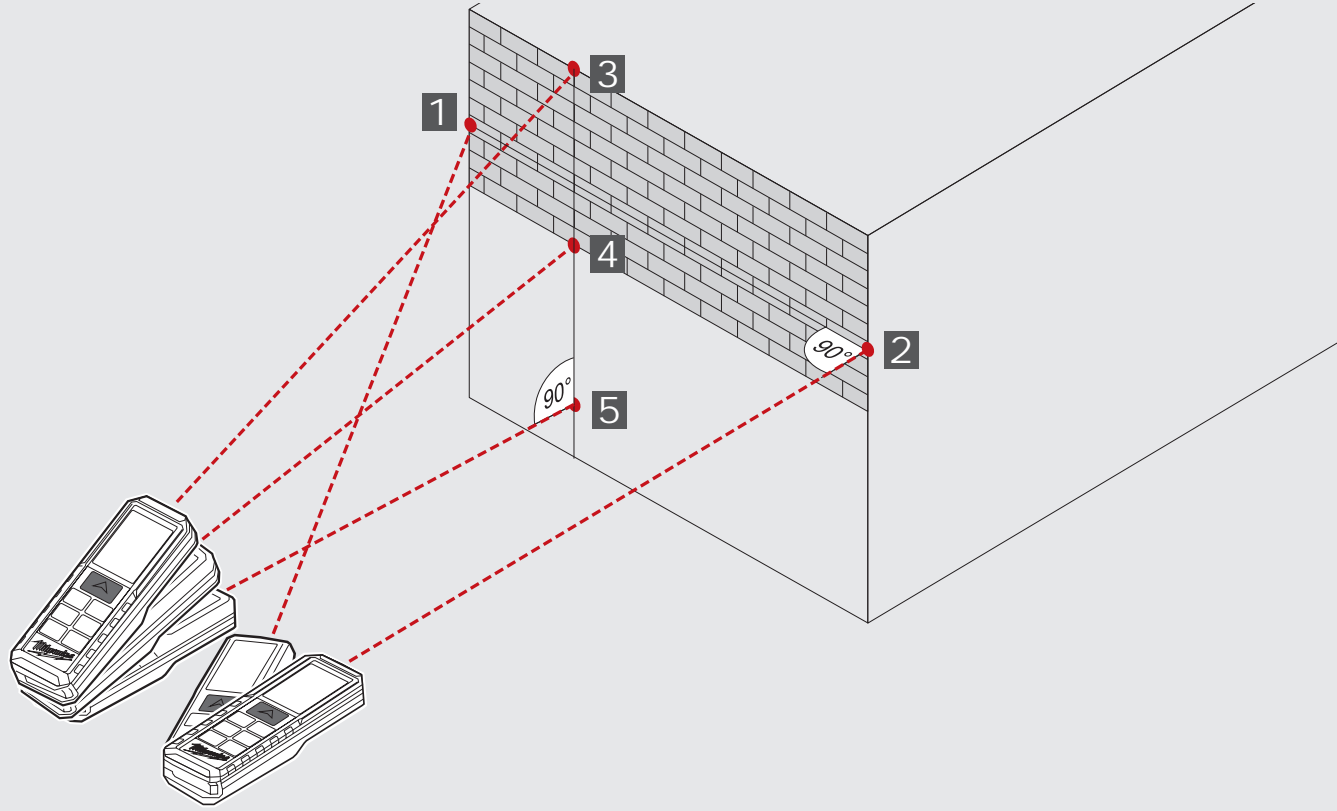

5

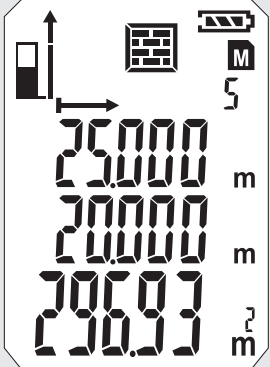



TIMER

Il timer permette di ritardare l'inizio della misurazione, ad es. per posizionare un componente nel raggio di misurazione.

Azionare il tasto 

- Appare il simbolo  e il simbolo  è possibile impostare il timer tra 3 e 15 sec.

Azionare il tasto 

- Parte il count-down fino alla misurazione.
- Raggiunto lo 0 viene attivata la misurazione.

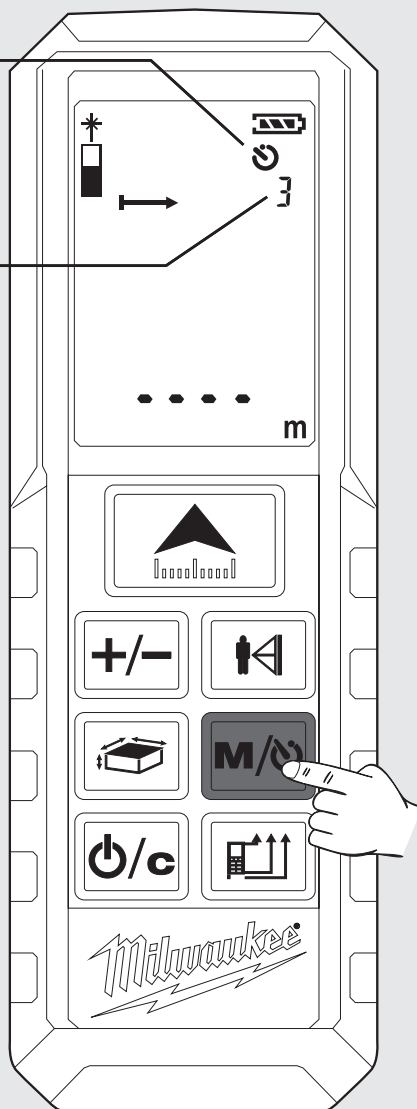



MEMORIA

I valori misurati vengono salvati automaticamente in memoria, in maniera progressiva.

I valori memorizzati possono essere chiamati con il tasto .

Tenere premuto il tasto  per 2 sec.

- Viene visualizzato il simbolo  e lo spazio di memoria.
- Viene visualizzato il relativo parametro di misura.
- Il valore memorizzato viene visualizzato nella riga principale.
- Leggere i valori in memoria premendo ripetutamente il tasto .

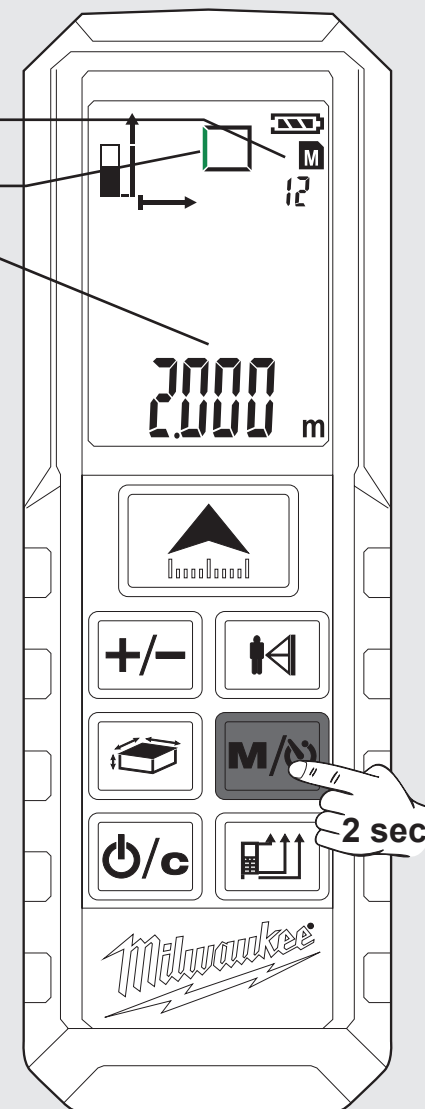

FUNZIONAMENTO DI BASE ESEMPLIFICATO PER LA MISURAZIONE DELLA SUPERFICIE (1)

1 Attivare **2 Selezionare il piano di misura** **3 Selezionare la funzione** **4 Misurare la lunghezza** **5 Misurazione larghezza**

Azionare il tasto 
⚠ Attenzione! Raggio laser on!
 Non dirigere su persone!

Impostazione di default
 all'accensione: posteriore
 Premere 1x -> perno d'angolo
 Premere 2x -> anteriore
 Premere 3x -> posteriore

All'accensione il dispositivo è
 sempre impostato su misurazione
 lunghezza.
 premere 1x - misurazione
 superficie

Orientare il
 dispositivo e
 premere il
 tasto 



Orientare il
 dispositivo
 e premere
 il tasto 

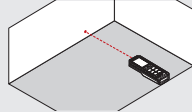

Il simbolo laser lampeggia
 (lampeggio indicato verde).

Viene visualizzato il simbolo

- Viene visualizzato il simbolo
 - Lampeggia il parametro misurato
 (lampeggio indicato verde)

- Il valore misurato appare
 brevemente nella riga principale.
 - Dopo 1 sec. il valore misurato si
 sposta alla riga superiore.
 Il valore misurato viene
 memorizzato con numero
 progressivo.
 - Lampeggia il secondo parametro
 misurato. Il dispositivo è pronto per
 la misurazione del secondo valore.

- Il valore misurato appare
 brevemente nella riga principale.
 - Dopo 1 sec. il valore misurato si
 sposta alla riga superiore.
 Il valore misurato viene
 memorizzato con numero
 progressivo.
 - Il risultato viene visualizzato nella
 riga principale e salvato in memoria
 con un numero progressivo.

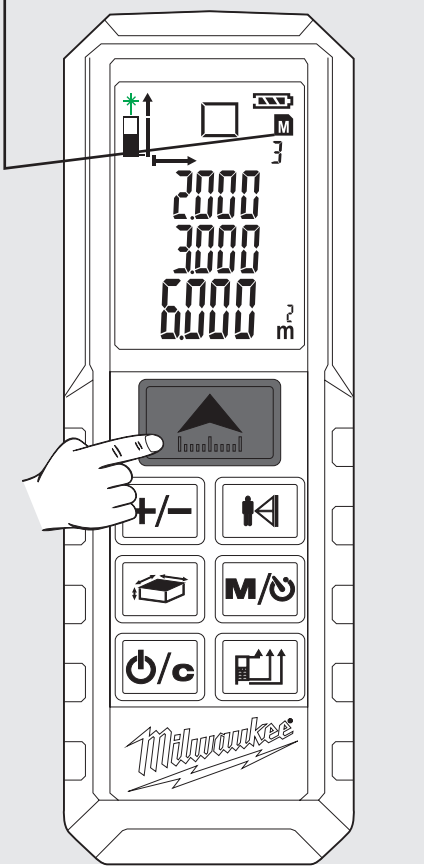
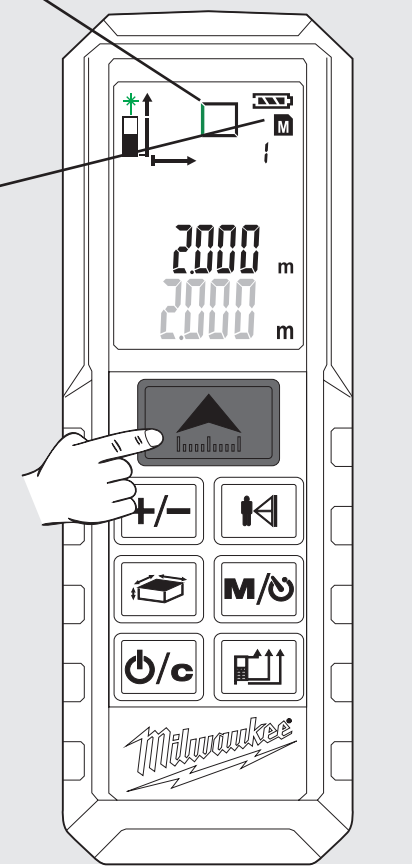
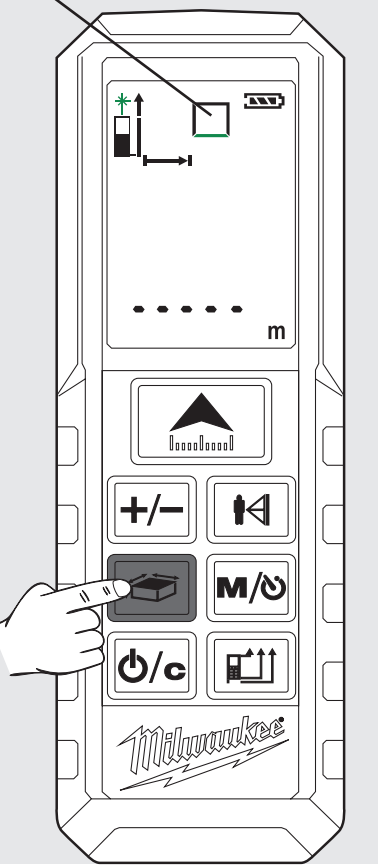
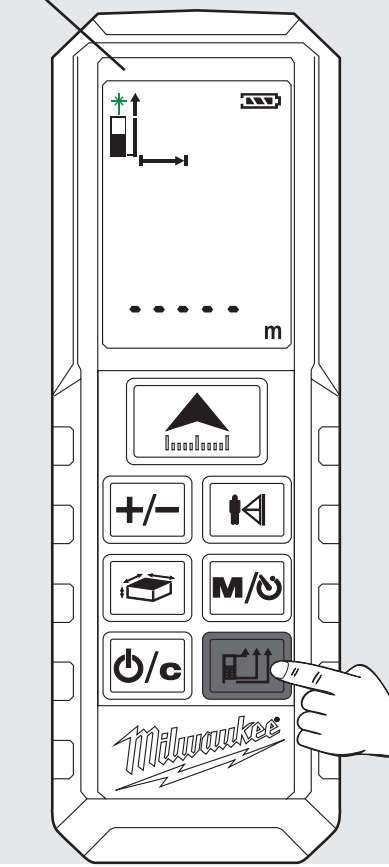
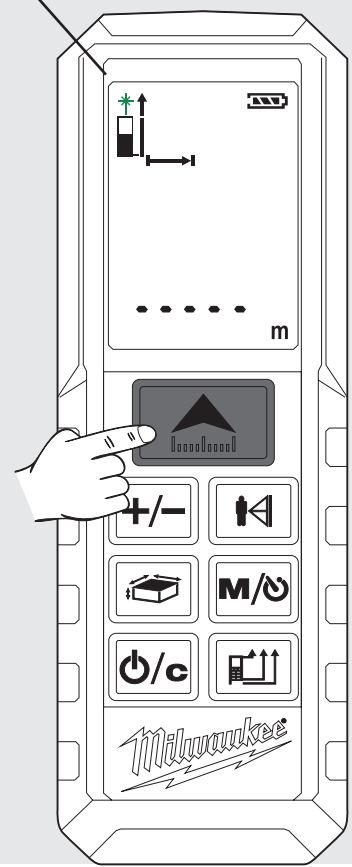

FUNZIONAMENTO DI BASE ESEMPLIFICATO PER LA MISURAZIONE DELLA SUPERFICIE (2)

6 Chiamare i valori salvati

Tenere premuto il tasto **M/0** per 2 sec.
Premere ripetutamente il tasto **M/0**.

- I valori memorizzati vengono visualizzati nella riga principale.
- Viene visualizzato il relativo simbolo e lampeggia il parametro misurato (lampeggio indicato verde).

7 Uscire dalla memoria

Azionare il tasto **0/c**

8 Disattivare

Mantenere premuto il tasto **0/c** per 2 sec
(E' necessario uscire prima dalla memoria).

- Il dispositivo si spegne.
- Se per 3 minuti non verrà azionato alcun tasto, il dispositivo si spegnerà automaticamente.

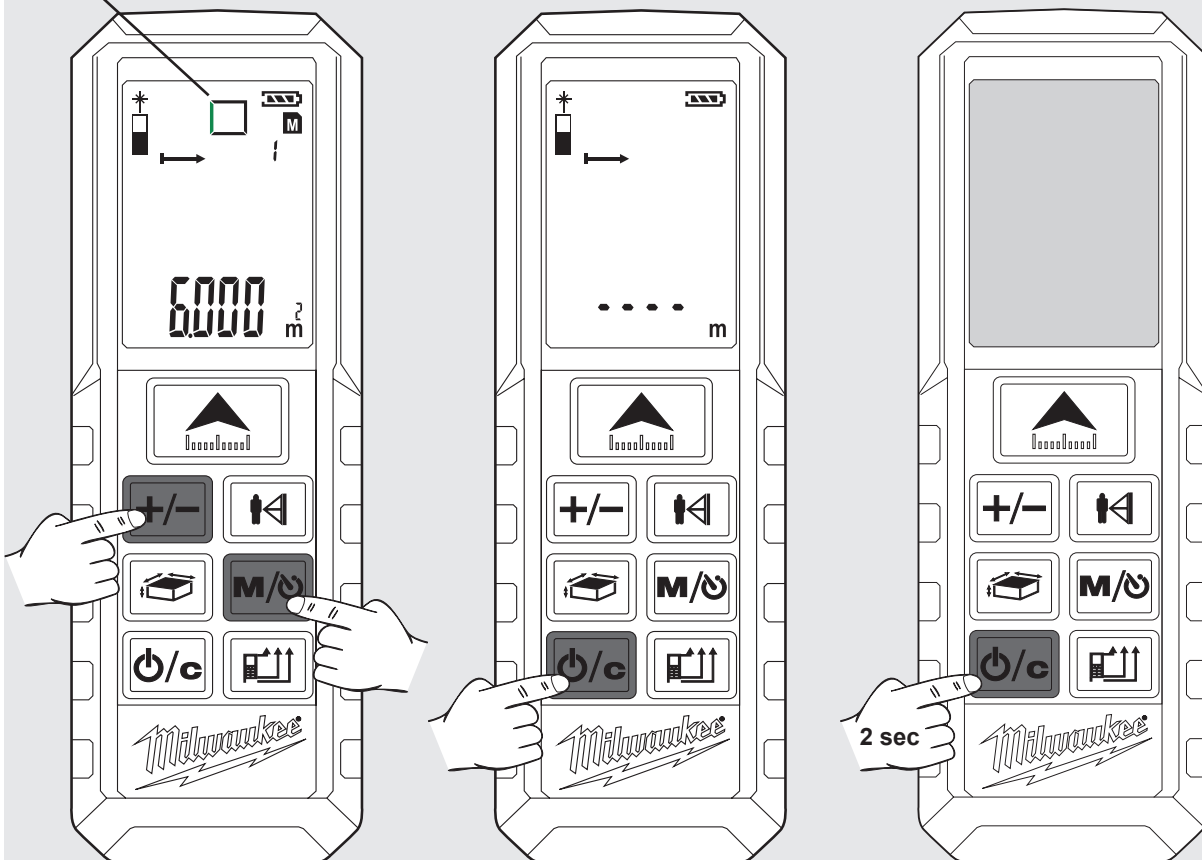

CONTENIDO

Instrucciones de seguridad importantes.....	1
Datos técnicos.....	2
Aplicación de acuerdo a la finalidad.....	2
Tabla de códigos de error.....	2
cuadro sinóptico.....	3
Cambiar baterías.....	4
Punta de ángulos.....	4
Sujeción del cinturón.....	4
Tecla de función, Pitágoras, plano de medición.....	5
Medición de longitud simple.....	6
Medición continua / Medición mínima - máxima.....	7
Medición de adición / sustracción.....	8
Medición de superficies.....	9
Medición de volumen.....	10
Medición indirecta (Pitágoras 1).....	11
Medición indirecta (Pitágoras 2).....	12
Medición indirecta (Pitágoras 3).....	13
Medición de superficies de paredes (escenario 1).....	14
Medición de superficies de paredes (escenario 2).....	15
Temporizador.....	16
Memoria.....	16
Funcionamiento básico poniendo como ejemplo una medición de superficies (1).....	17
Funcionamiento básico poniendo como ejemplo una medición de superficies (2).....	18

INSTRUCCIONES DE SEGURIDAD IMPORTANTES



Lea detenidamente las Instrucciones de seguridad y el Manual de empleo que se encuentran en el CD adjunto antes de empezar a trabajar con el producto.

Clasificación de láser

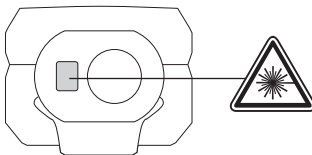

ADVERTENCIA:

El producto corresponde a la Clase de láser 2 según la norma EN60825-1:2014.



λ 650 nm P<1 mW

Advertencia:

Evite el contacto directo con los ojos. Debido a la intensa brillantez del rayo láser se puede producir un deslumbramiento durante un breve período de tiempo.

Absténgase de mirar directamente al rayo láser y no dirija éste a otras personas.

No deslumbrar intencionadamente a terceros.

Advertencia:

No hacer funcionar el aparato láser cerca de niños o permitir a los niños que utilicen el aparato láser.

¡Atención! Una superficie reflectante podría dirigir el rayo láser de vuelta hacia el operador o hacia otra persona.

Respetar una distancia de seguridad de las partes móviles.

Realizar periódicamente mediciones de control. Especialmente cuando el producto ha estado sometido a esfuerzos excesivos así como antes y después de tareas de medición importantes.

Pueden producirse medidas erróneas si se utiliza un producto que esté defectuoso, después de haberse caído o haber sido objeto de transformaciones no permitidas.

Advertencia: El empleo de elementos de control, ajustes u operaciones diferentes a las especificadas en el manual podrían derivar en la exposición a una radiación peligrosa.

El aparato de medición por láser tiene un campo de aplicación limitado. (Véase capítulo "Datos técnicos"). Los intentos de medir fuera del rango máximo y mínimo ocasionan inexactitudes. El uso en condiciones meteorológicas adversas como por ejemplo demasiado calor, demasiado

frío, luz solar brillante, lluvia, nieve, niebla u otras condiciones que limitan la visión, pueden producir mediciones inexactas.

Si el aparato de medición por láser se lleva de un ambiente cálido a un ambiente frío (o al revés), espere hasta que el aparato se haya adaptado a la nueva temperatura ambiente

Guardar el aparato de medición por láser siempre en el interior de locales, proteger el aparato contra sacudidas y vibraciones o temperaturas extremas

Proteger el aparato de medición por láser siempre contra polvo, humedad y alta humedad del aire. Esto puede destruir los componentes internos o influir en la exactitud.

No utilice detergentes o disolventes agresivos. Limpiar solamente con un paño limpio y blando.

Evite golpes fuertes sobre el aparato de medición por láser o la caída del mismo. Se debería comprobar la exactitud del aparato, si éste se ha caído o si ha estado expuesto a otras cargas mecánicas.

Las reparaciones necesarias en este aparato láser deben ser realizadas únicamente por personal especializado y autorizado.

No utilizar el producto en áreas con una atmósfera potencialmente explosiva o volátil.

Utilice sólo los cargadores recomendados por el fabricante para cargar las baterías.

 Los residuos de pilas y de aparatos eléctricos y electrónicos no se deben desechar junto con la basura doméstica. Los residuos de pilas y de aparatos eléctricos y electrónicos se deben recoger y desechar por separado.

Retire los residuos de pilas y acumuladores, así como las fuentes de iluminación de los aparatos antes de desecharlos.

Infórmese en las autoridades locales o en su distribuidor especializado sobre los centros de reciclaje y los puntos de recogida.

Dependiendo de las disposiciones locales al respecto, los distribuidores minoristas pueden estar obligados a aceptar de forma gratuita la devolución de residuos de pilas, aparatos eléctricos y electrónicos.

Contribuya mediante la reutilización y el reciclaje de sus residuos de pilas y de aparatos eléctricos y electrónicos a reducir la demanda de materias primas.

Los residuos de pilas (sobre todo de pilas de iones de litio) y de aparatos eléctricos y electrónicos contienen valiosos materiales reutilizables que pueden tener efectos negativos para el medio ambiente y su salud si no son desechados de forma respetuosa con el medio ambiente.

Antes de desecharlos, elimine los datos personales que podría haber en los residuos de sus aparatos.

 Marcado de conformidad europeo

 Marcado de conformidad británico

 Marcado de conformidad ucraniano

 Marcado de conformidad euroasiático

DATOS TÉCNICOS

Clase de protección	IP54 (protegido contra el polvo y las salpicaduras de agua)
Sistema óptico	14 mm
Foco	35 mm
Rango máximo de medición	50 metros (tolerancia 55m)
Rango mínimo de medición	0,05 metros
Exactitud absoluta @ < 10m	± 1,5 mm (máx.)
Precisión de repetición @ < 10m	± 1,5 mm (valor típico como máx. 2σ)
Precisión de repetición @ > 10m	Aumento ± 0,25 mm / metros (valor típico como máx. 2σ)
Tiempo de medición	0,5 s
Tipo de display	LCD (22,7 mm x 31 mm)
Alimentación de corriente	AAA 2x (batería alcalina)
Vida útil de la batería	10000 (medición individual)
Potencia de salida del láser	0,6 mW ~ 0,95 mW (Clase 2, 650nm)
Tamaño del punto creado por el láser	25 x 30 mm @ 16 m (máx.)
Clase de láser	2
Tipo de láser	650 nm, < 1 mW
Ángulo vertical del rayo láser	+1 grado
Ángulo horizontal del rayo láser	±1 grado
Desconexión automática del aparato	180 segundos
Desconexión automática del láser	30 segundos
Rango de temperatura de trabajo	-10°C a +50°C
Rango de temperatura de almacenamiento	-25°C a +70°C
Peso sin batería	80 g

APLICACIÓN DE ACUERDO A LA FINALIDAD

El aparato de medición por láser es apropiado para la medición de distancias e inclinaciones. No utilice este producto para ninguna otra aplicación que no sea su uso normal.

TABLA DE CÓDIGOS DE ERROR

Código	Descripción	Solución
Err01	Fuera del rango de medición	Realizar una medición dentro del rango previsto.
Err02	La señal reflejada es demasiado débil	Elegir una superficie mejor.
Err03	Fuera del rango de indicación (valor máx.: 99.999) por ej. el resultado de la superficie y del volumen está fuera del rango de indicación	Comprobar, si los valores y los pasos son correctos.
Err04	Error en el cálculo de Pitágoras	Comprobar, si los valores y los pasos son correctos.
Err05	Batería débil	Insertar baterías nuevas.
Err06	Fuera del rango de temperatura de trabajo	Realizar la medición dentro del rango de temperatura de trabajo previsto.
Err07	La luz ambiente es demasiado brillante	Oscurecer la zona de interés.

Pitágoras
Diferencia de altura

Plano de medición

Medición de longitud

Mínimo / Máximo para medición continua

Adición / Sustracción

ENCENDER / MEDIR

- ▶ Encender
- ▶ Medir
- ▶ Medición continua (apretar 2 segundos)
Función mín. / máx.

ADICIÓN / SUSTRACCIÓN

- ▶ Sumar el valor
- ▶ Navegar en la memoria

SUPERFICIE / VOLUMEN

- ▶ Superficie (apretar 1 vez)
- ▶ Volumen (apretar 2 veces)
- ▶ Medición indirecta de superficies (apretar 3 / 4 veces)

ENCENDER

- ▶ Encender
- ▶ Apagar (apretar 2 segundos)
- ▶ Reponer

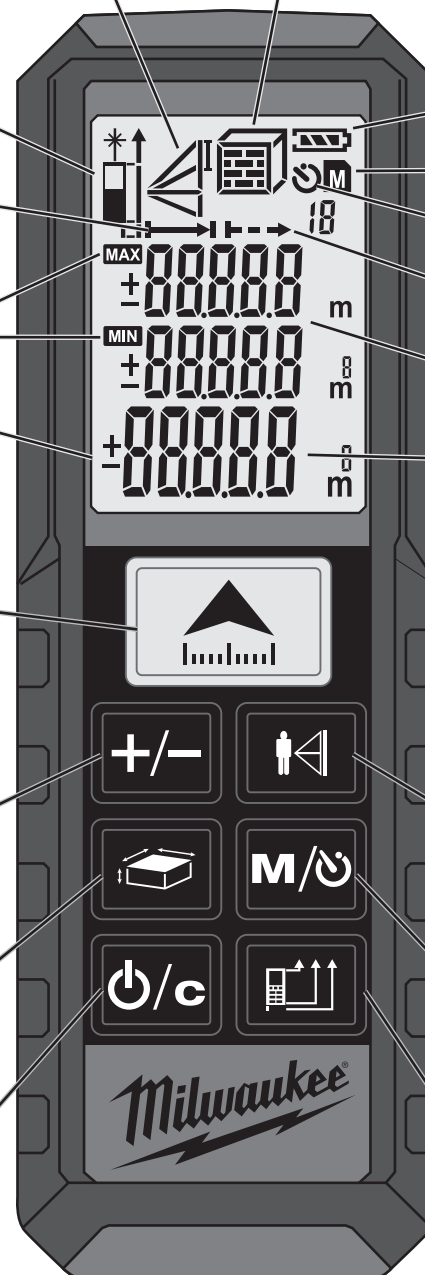

Superficie / Volumen
Medición indirecta de superficies

Estado de carga de la batería

Memoria

Temporizador

Medición continua

Valores intermedios

Valor total

PITÁGORAS

- ▶ Pitágoras 1 (apretar 1 vez)
- ▶ Pitágoras 2 (apretar 2 veces)
- ▶ Pitágoras 3 (apretar 3 veces)

MEMORIA

- ▶ Temporizador 3-15 segundos (apretar 1 vez)
- ▶ Memoria 1-20 (apretar 1 vez 2 segundos)
- ▶ Visualizar los valores guardados (pulsar varias veces)

CAMBIAR PLANO DE MEDICIÓN

- ▶ Delante
- ▶ Atrás
- ▶ Punta de ángulos

CAMBIAR BATERÍAS

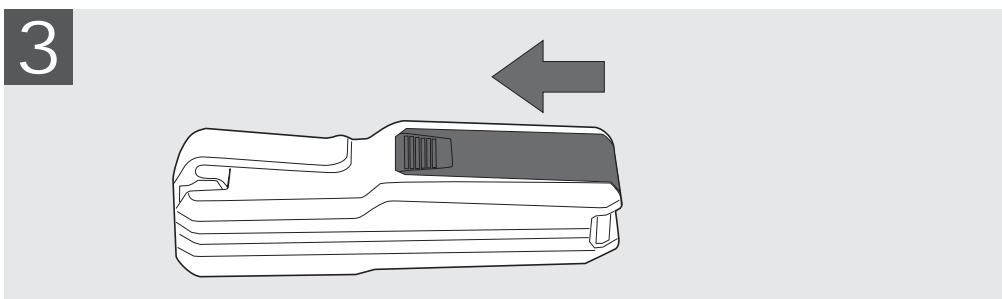
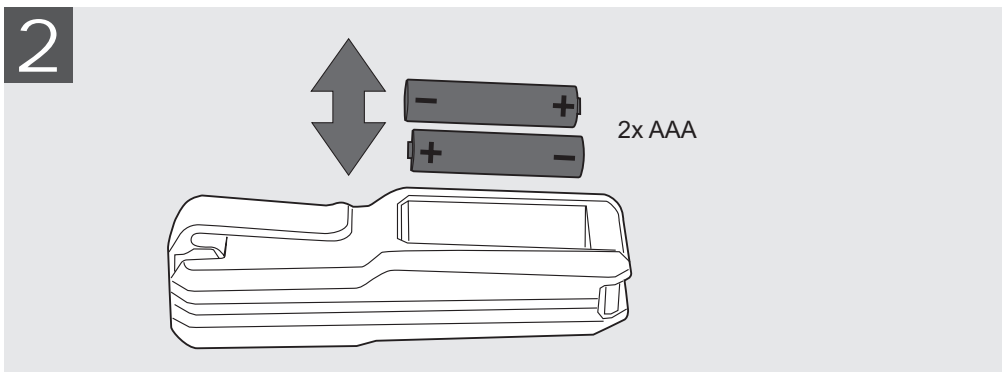
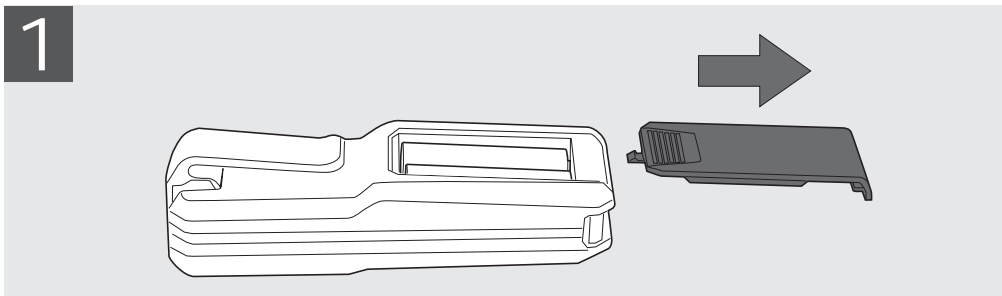
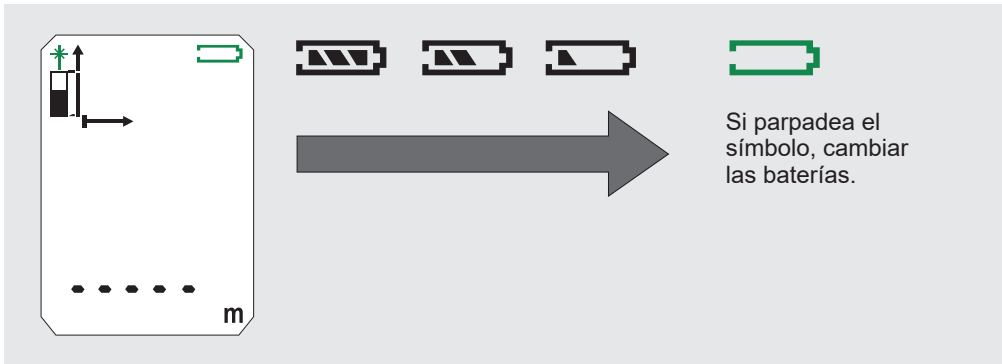

PUNTA DE ÁNGULOS

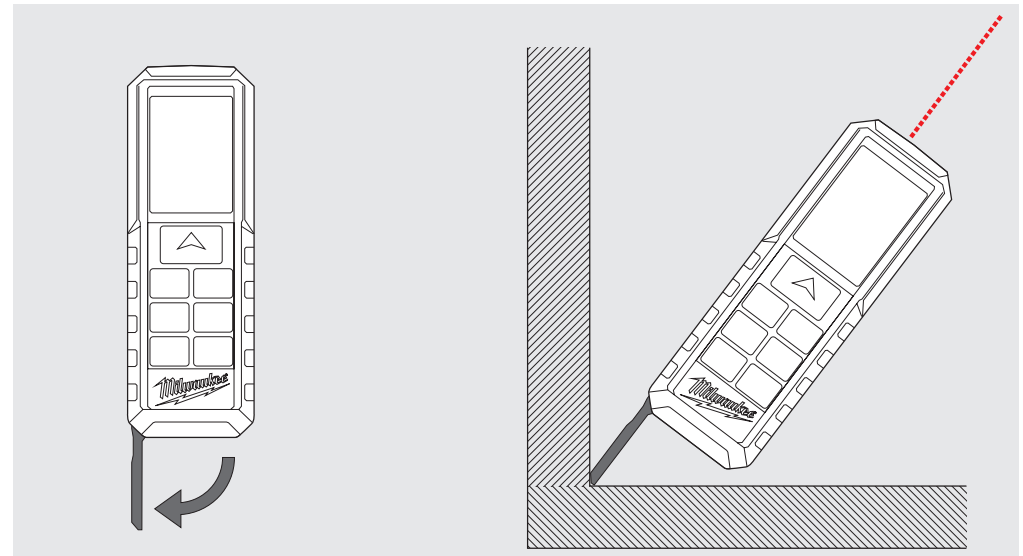

SUJECIÓN DEL CINTURÓN

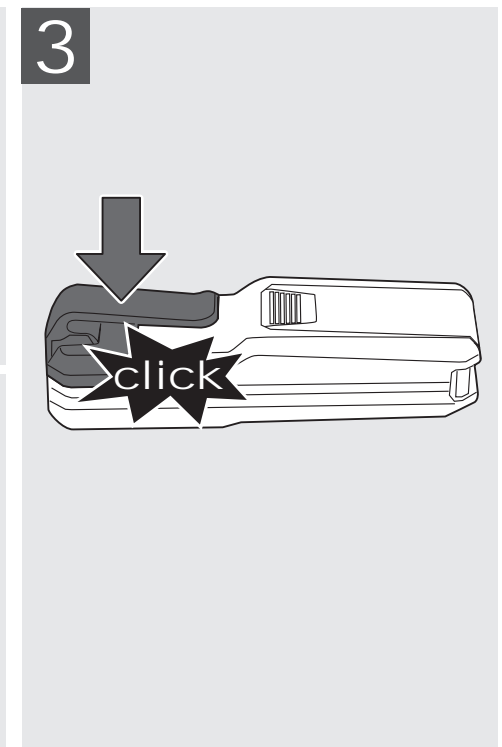
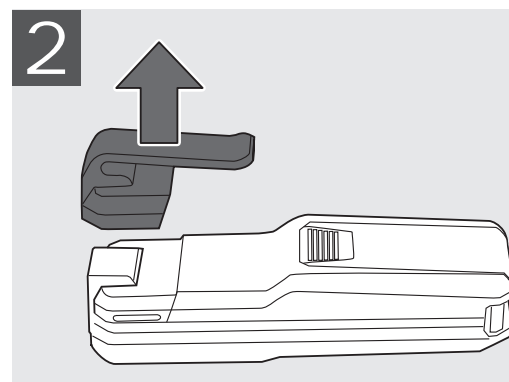
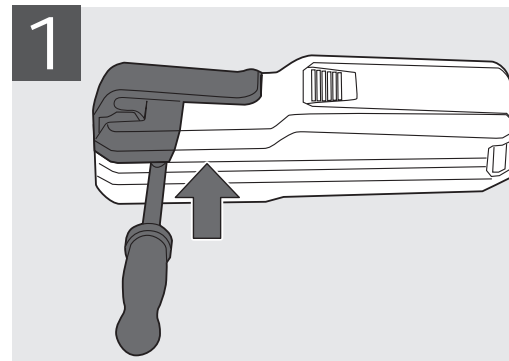

TECLA DE FUNCIÓN, PITÁGORAS, PLANO DE MEDICIÓN

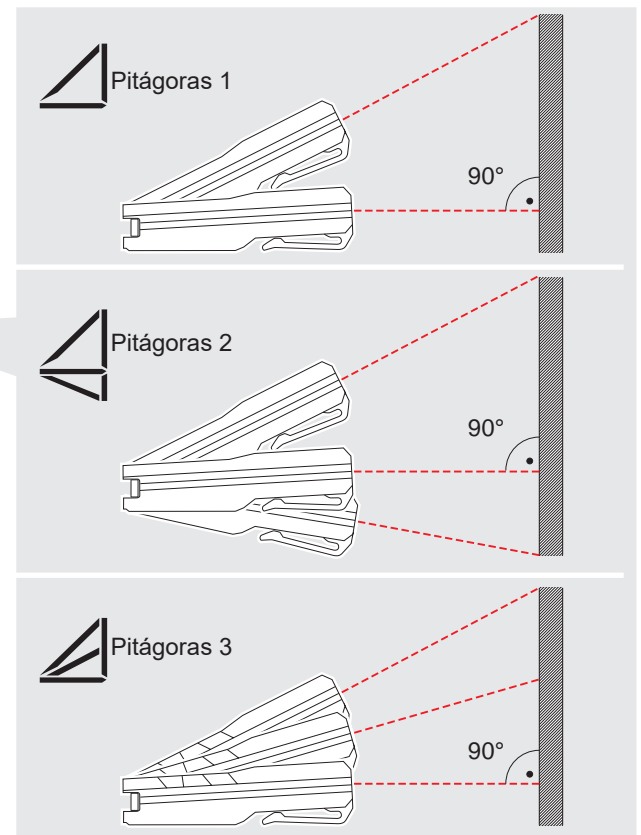
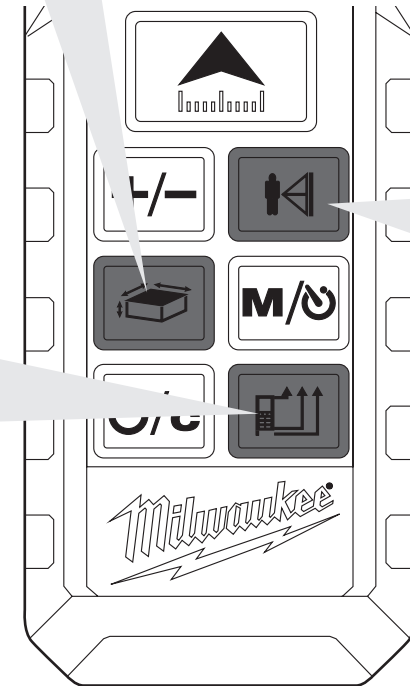
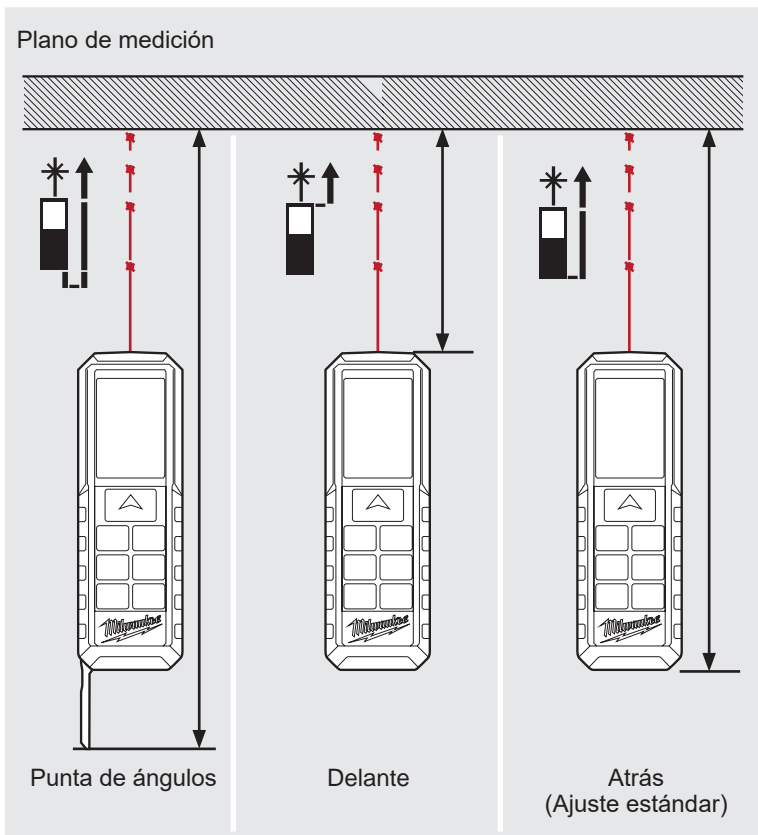
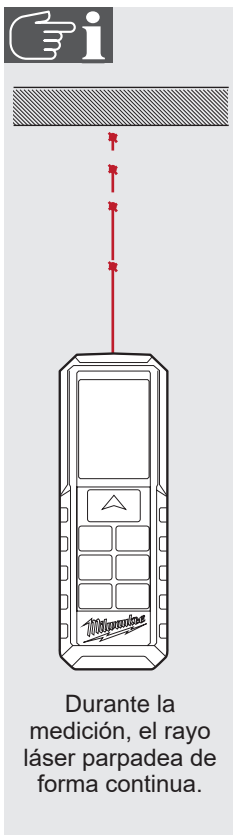
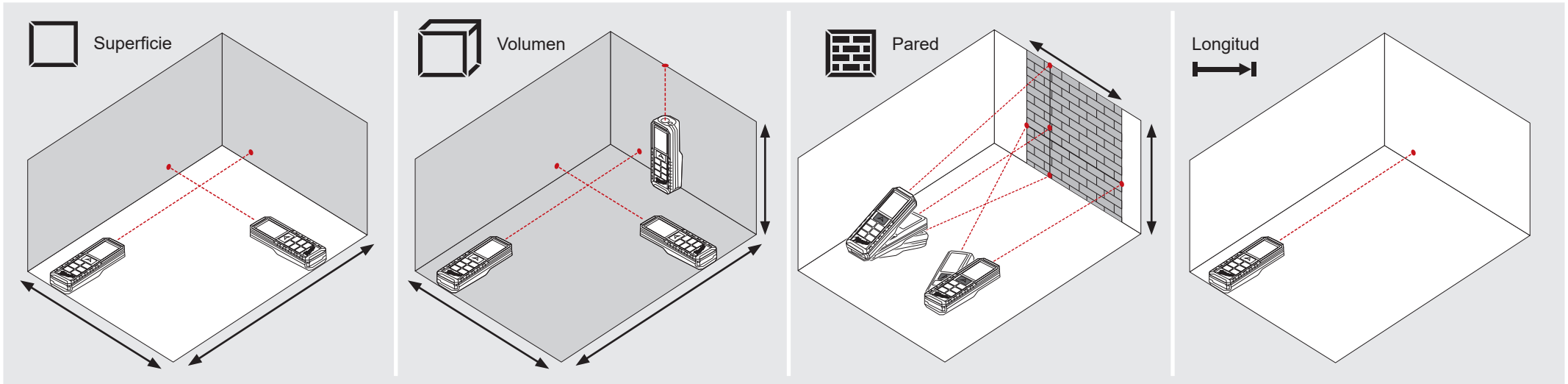

MEDICIÓN DE LONGITUD SIMPLE

0

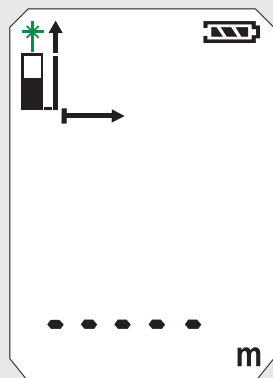

1

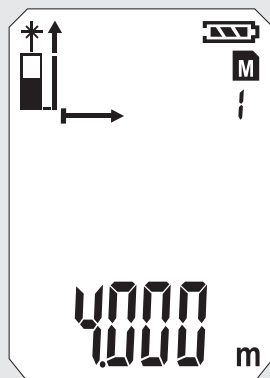

2

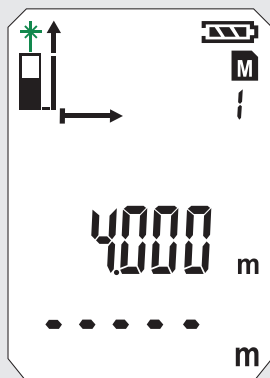

3

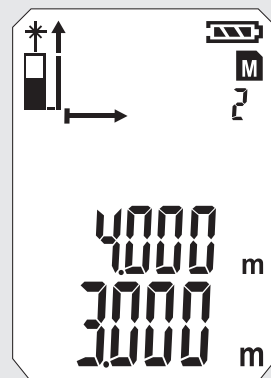

4

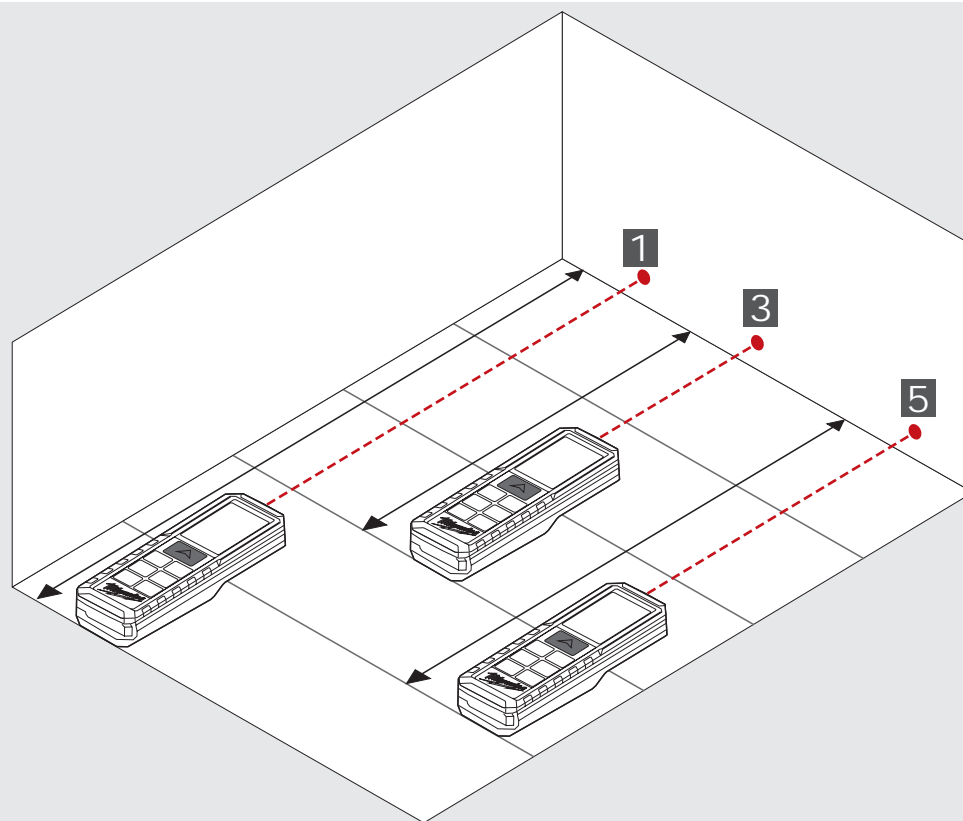
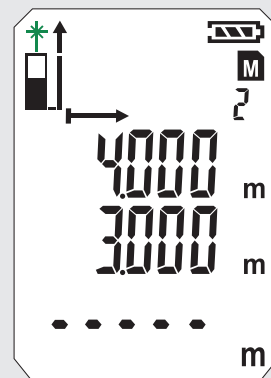

5

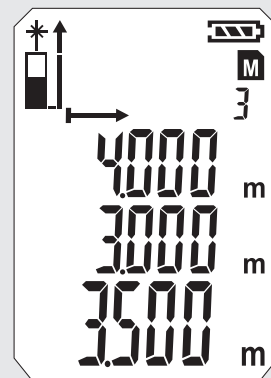

MEDICIÓN CONTINUA / MEDICIÓN MÍNIMA - MÁXIMA

0

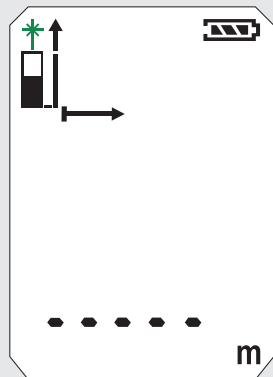

1

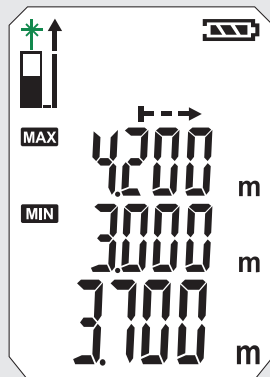

2

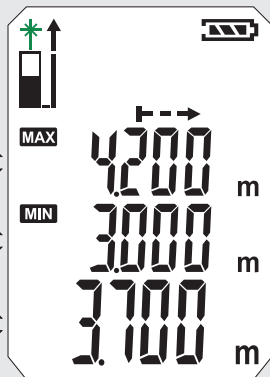
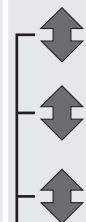

3



Stop
MIN / MAX

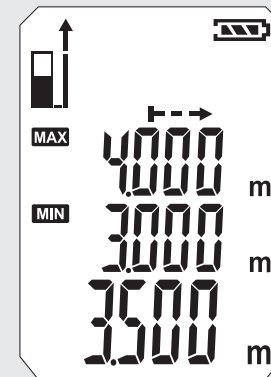

4

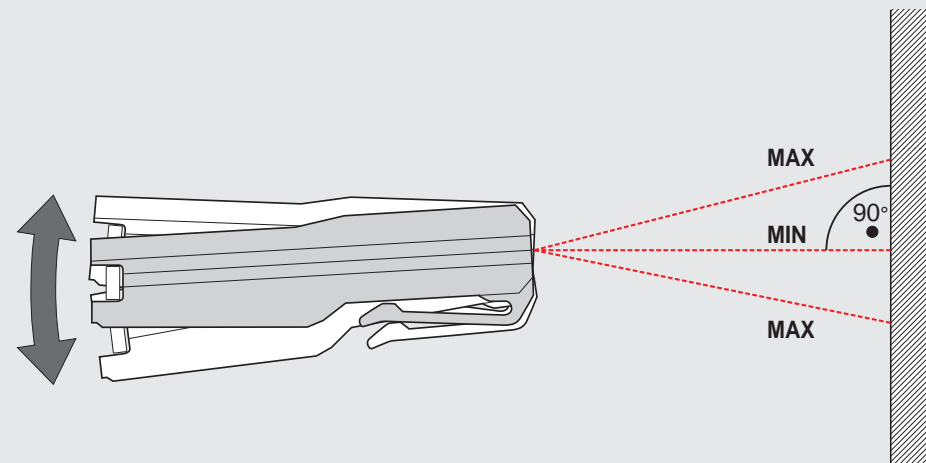
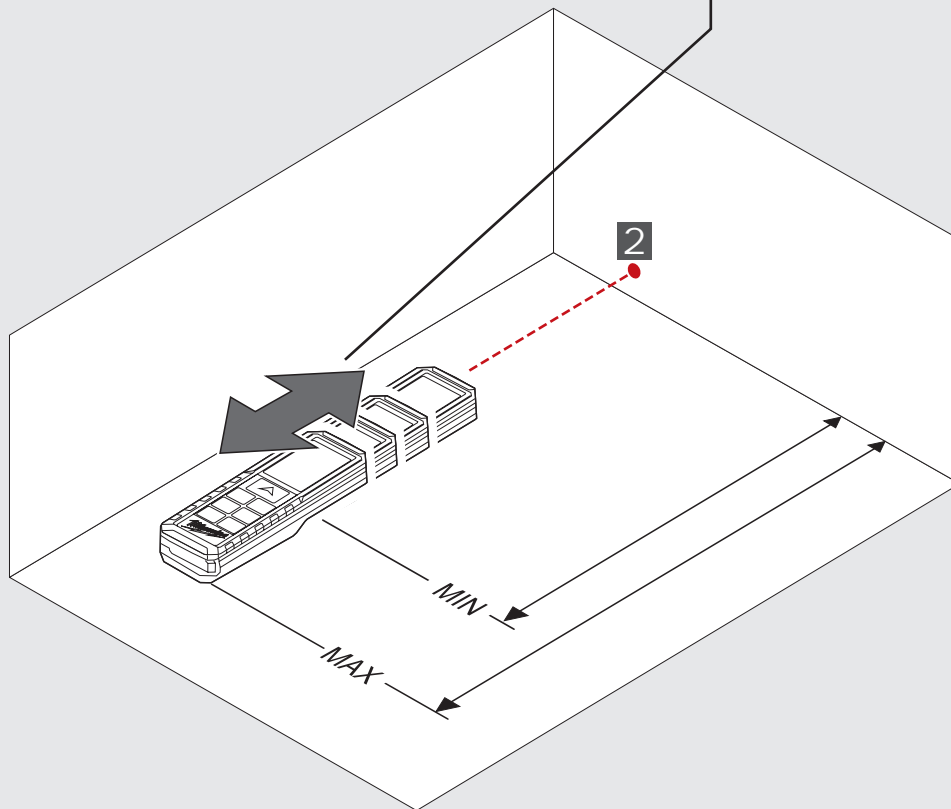
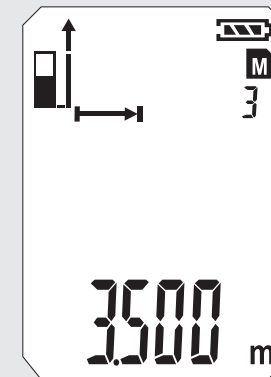

0

1

2

3

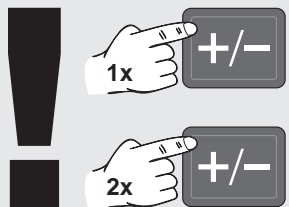
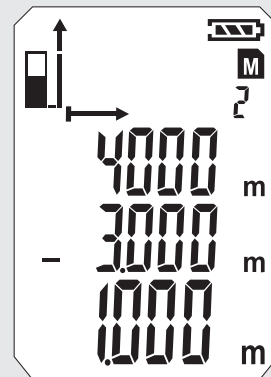
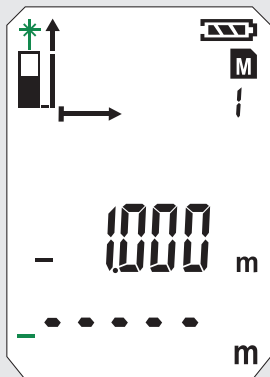
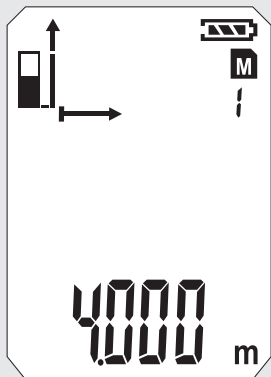
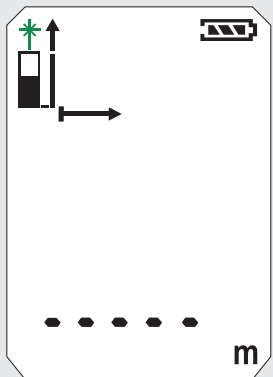

→ +



→ -

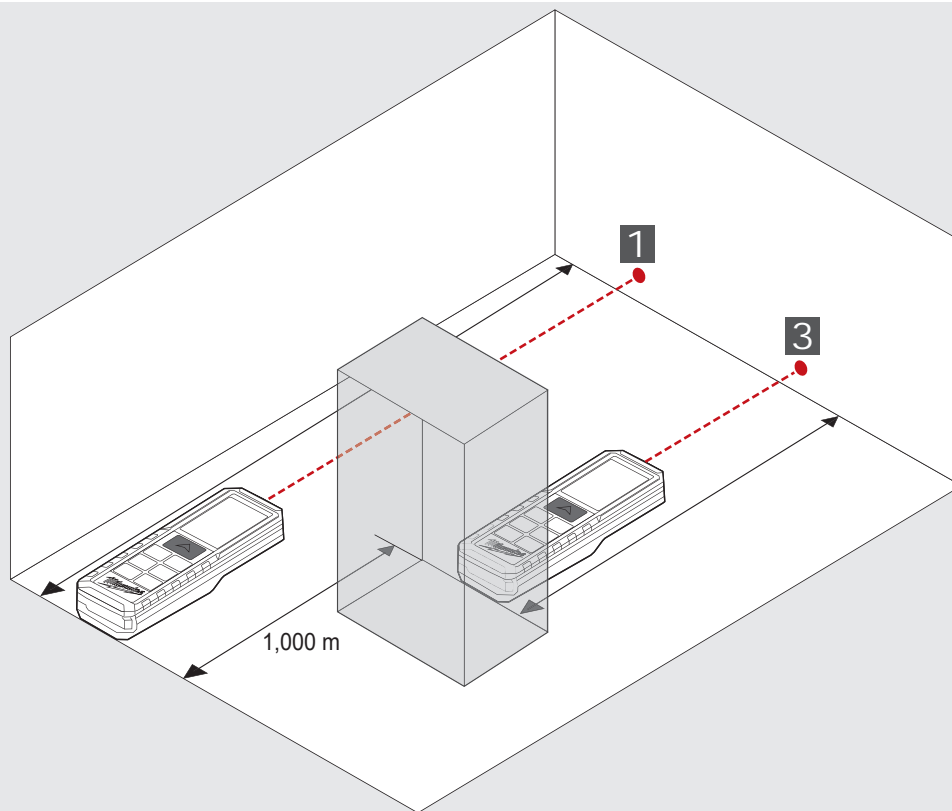

MEDICIÓN DE SUPERFICIES

0



1



2

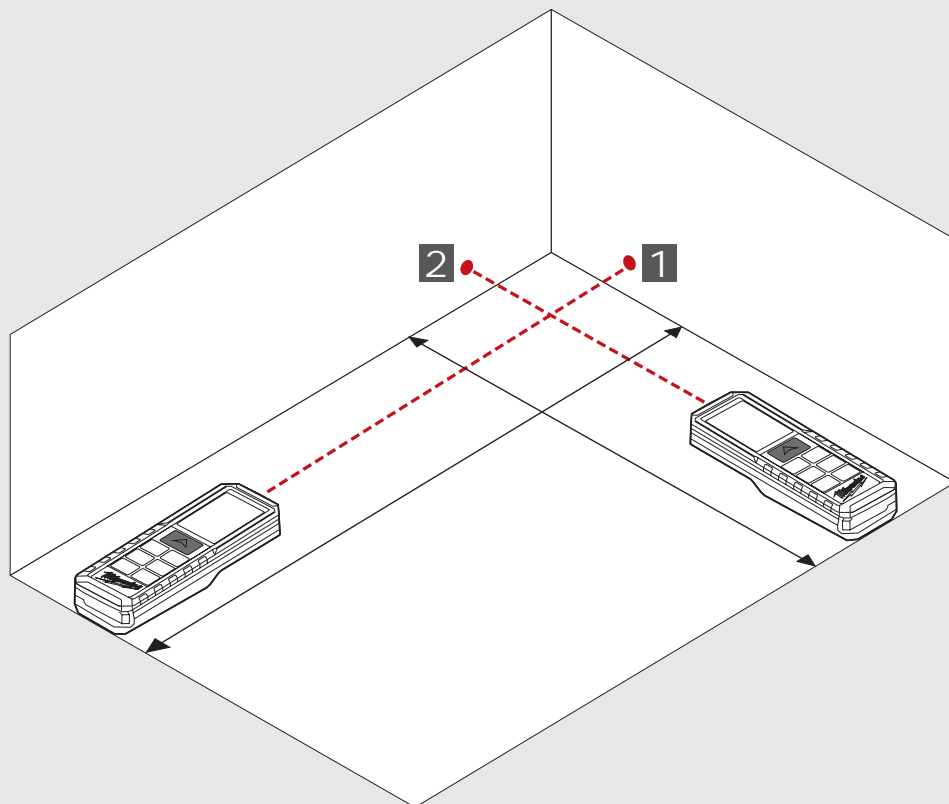
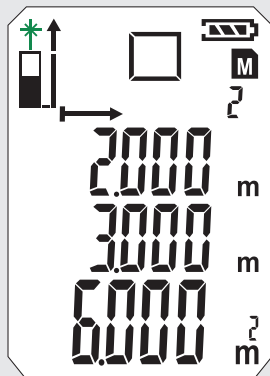
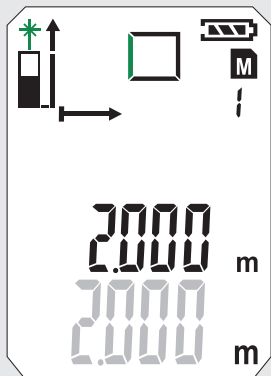
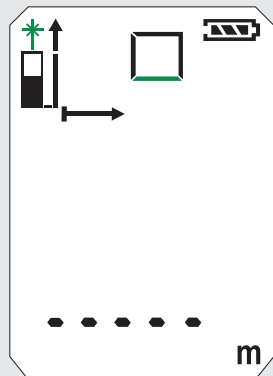

MEDICIÓN DE VOLUMEN

0



1



2



3

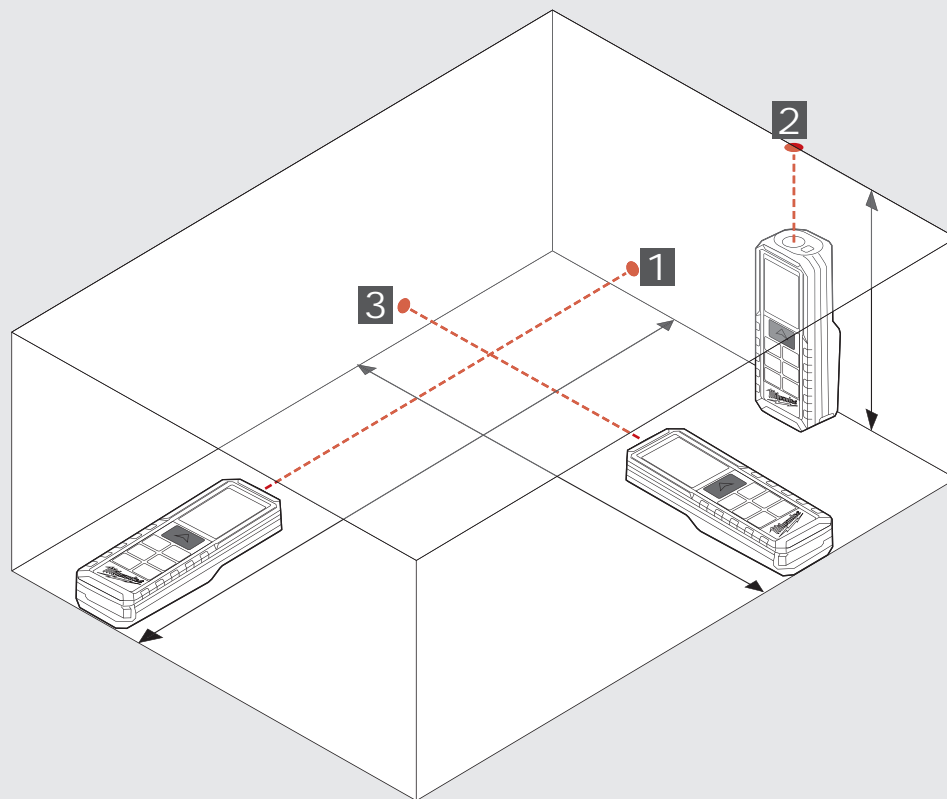
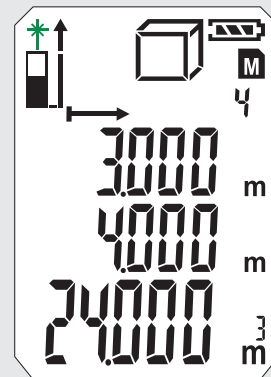
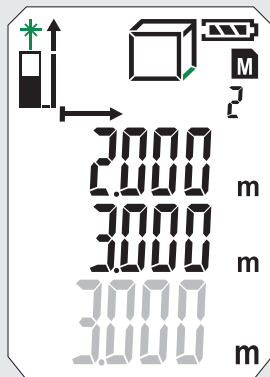
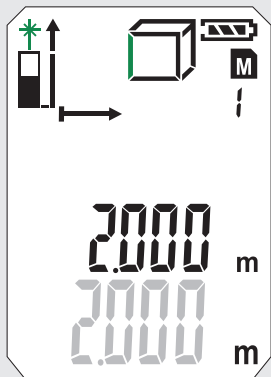
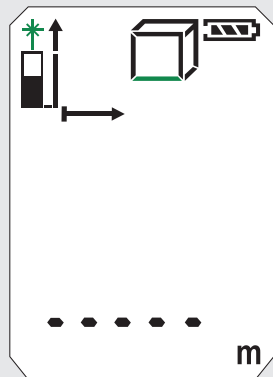

MEDICIÓN INDIRECTA (PITÁGORAS 1)

0



1



2

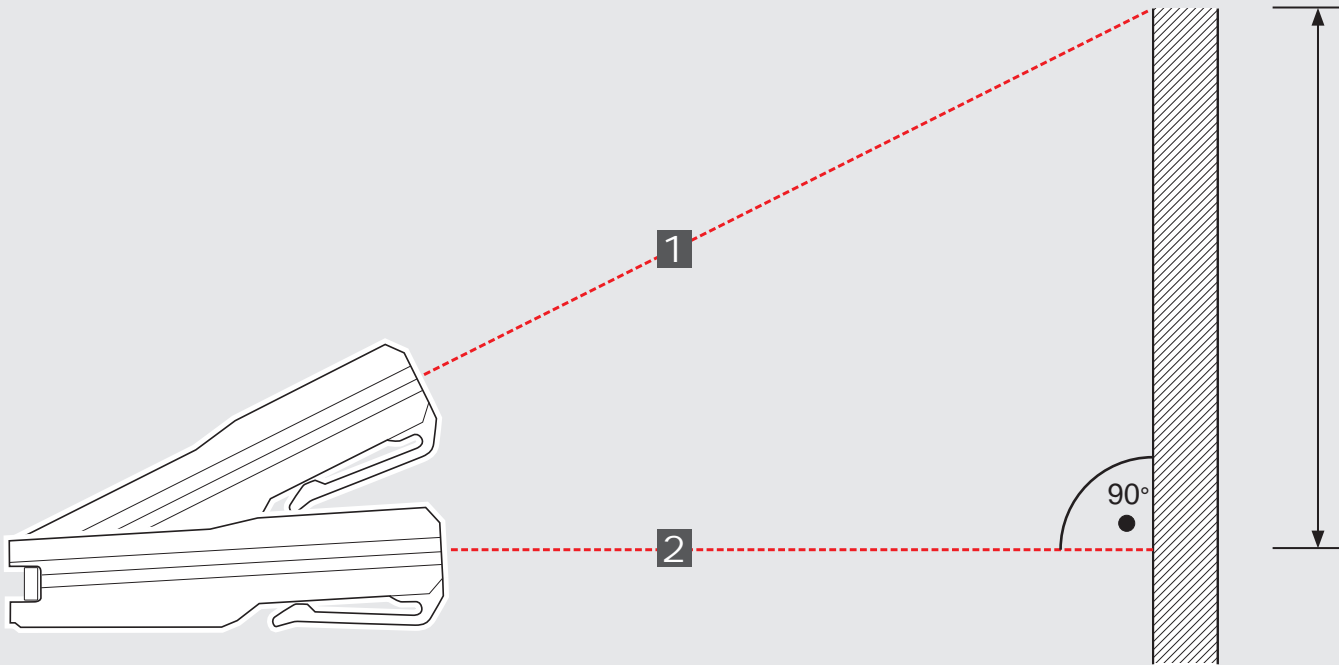
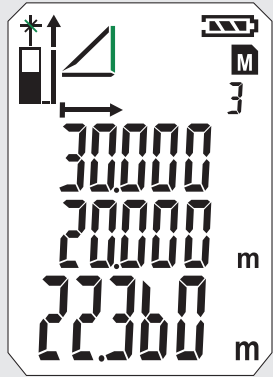
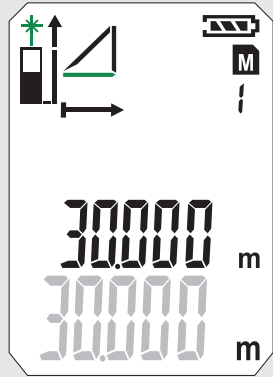
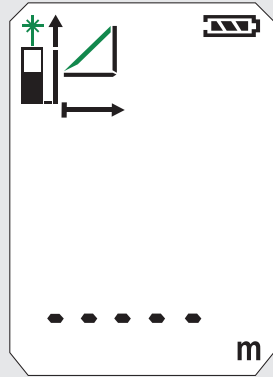

MEDICIÓN INDIRECTA (PITÁGORAS 2)

0



2 x

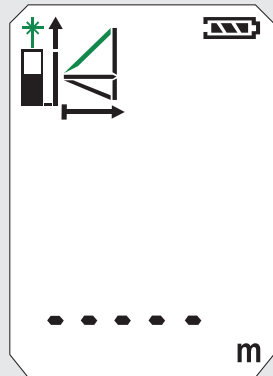

1

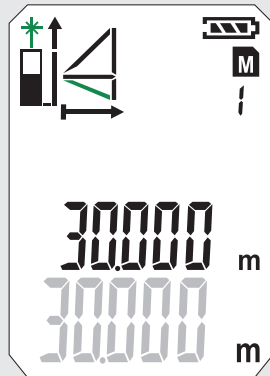

2

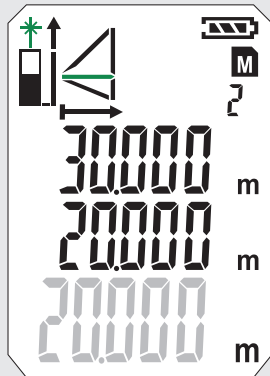

3

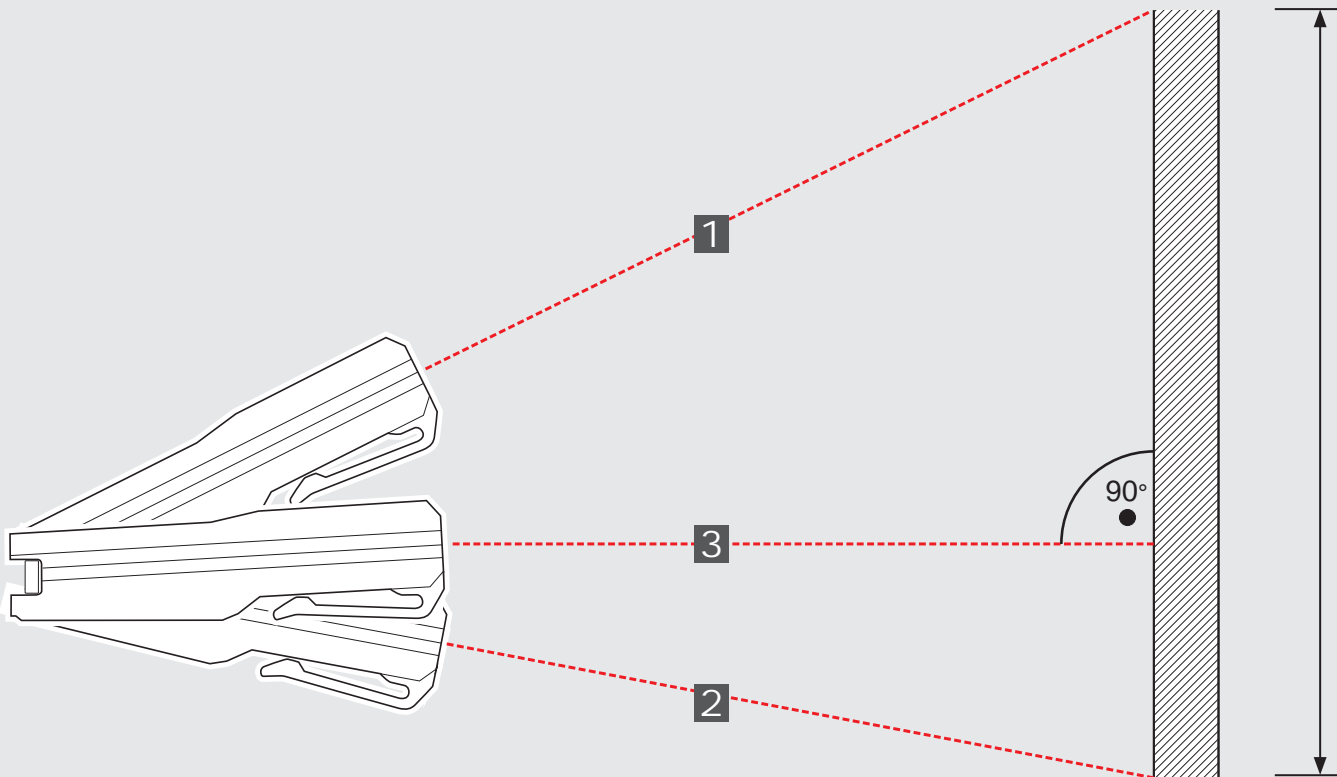
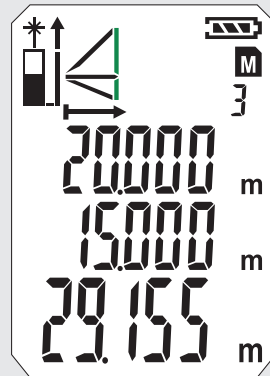

MEDICIÓN INDIRECTA (PITÁGORAS 3)

1



2







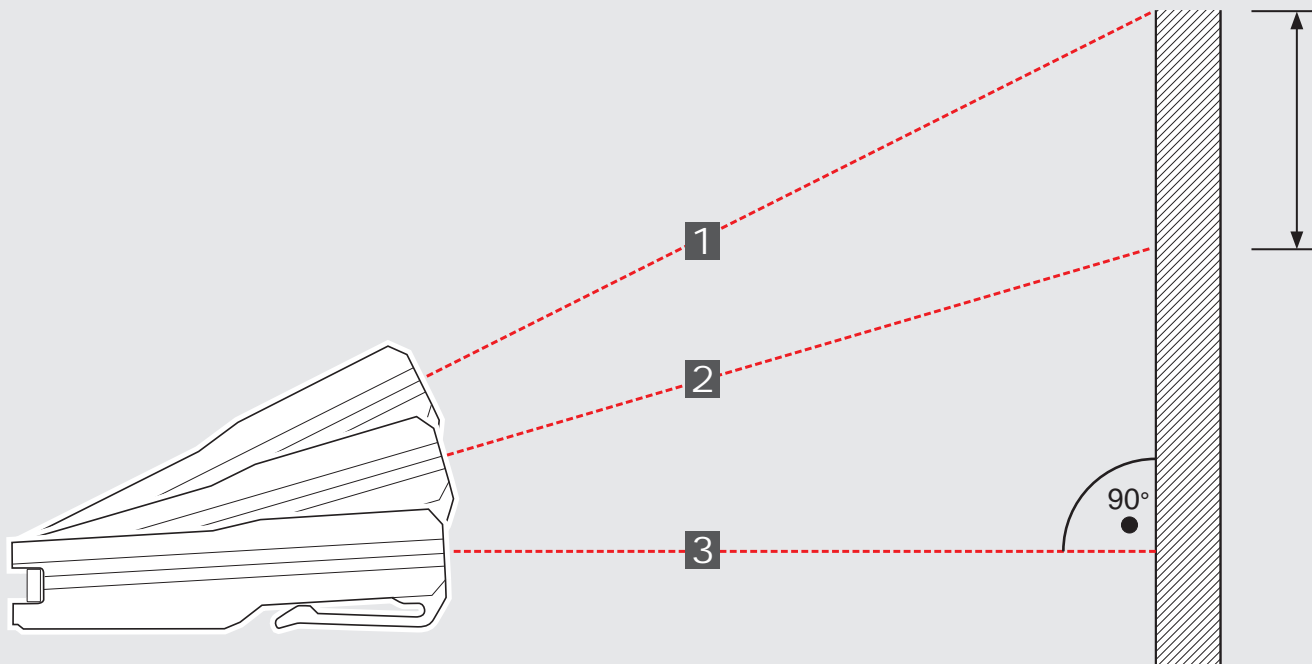
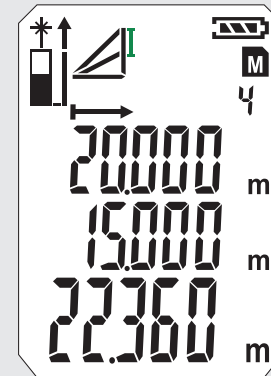
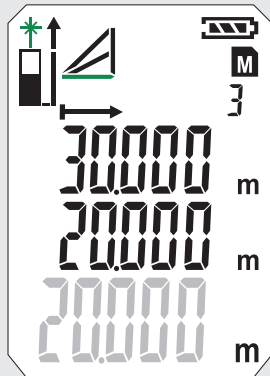
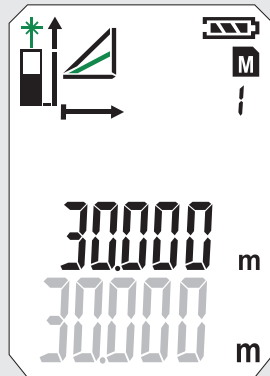
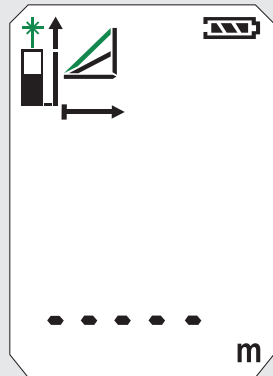

3



4



MEDICIÓN DE SUPERFICIES DE PAREDES (ESCENARIO 1)

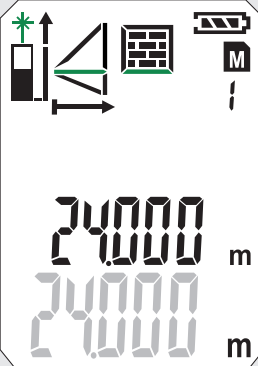
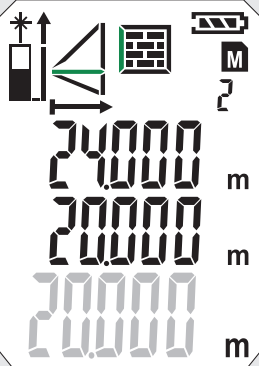
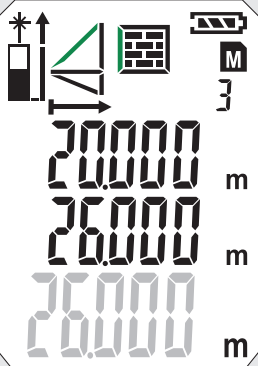
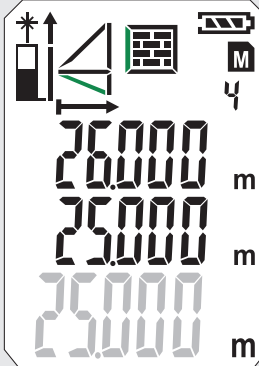

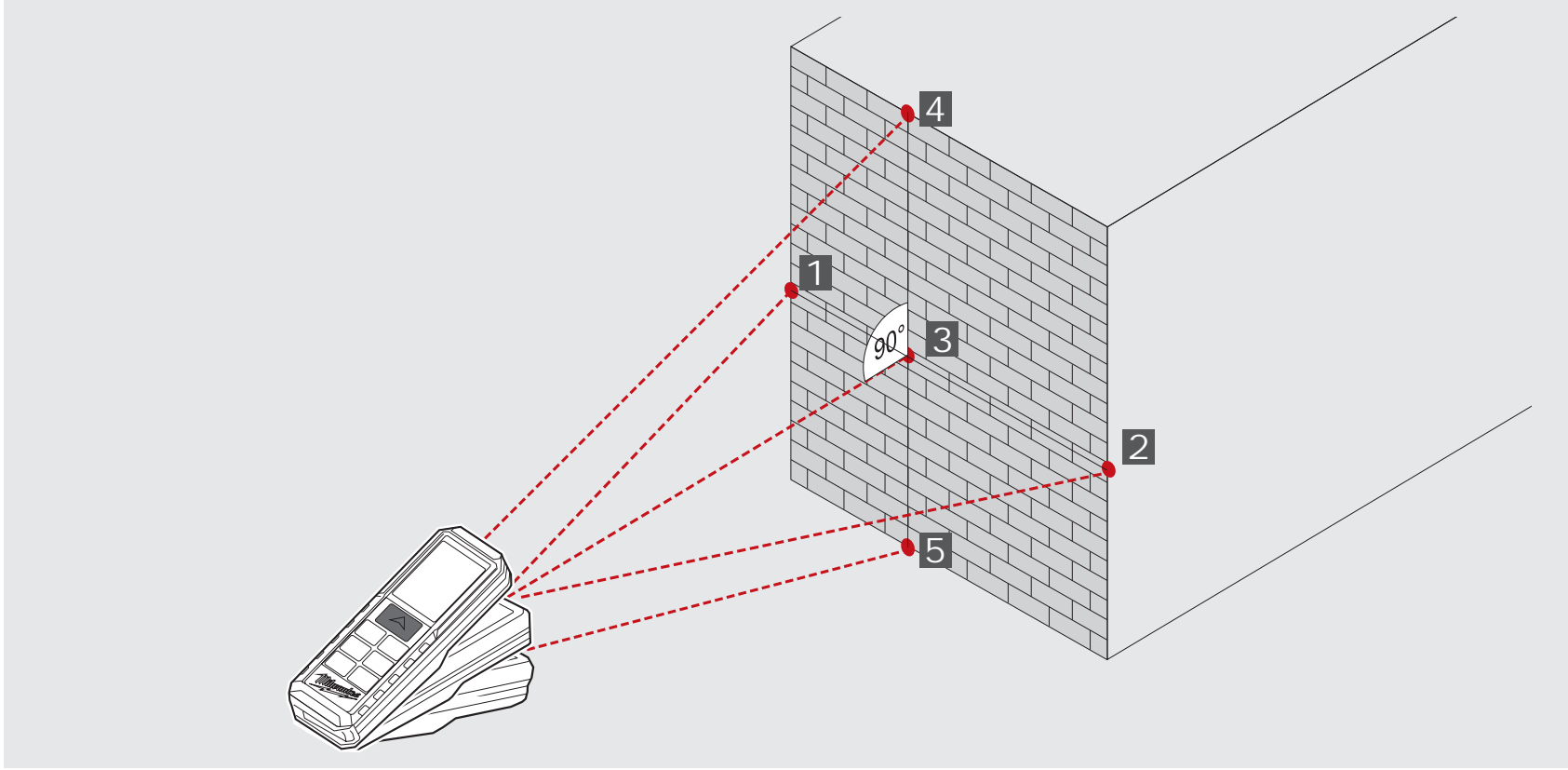

<p>0</p> 	<p>1</p> 	<p>2</p> 	<p>3</p> 	<p>4</p> 
				

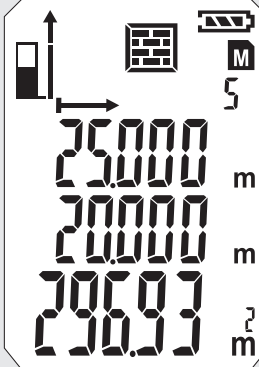

5



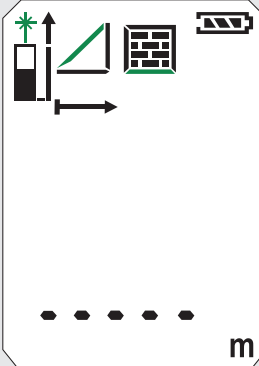
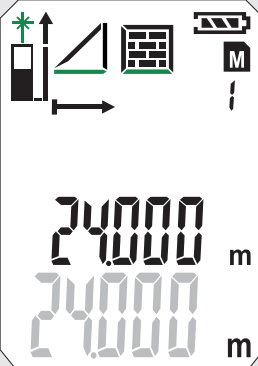
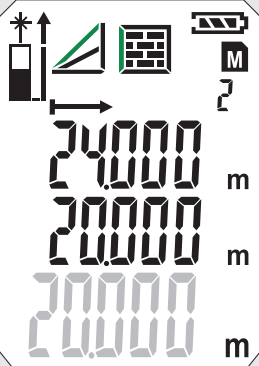
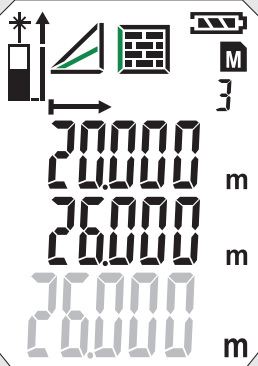
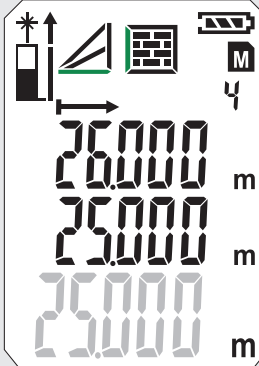

MEDICIÓN DE SUPERFICIES DE PAREDES (ESCENARIO 2)

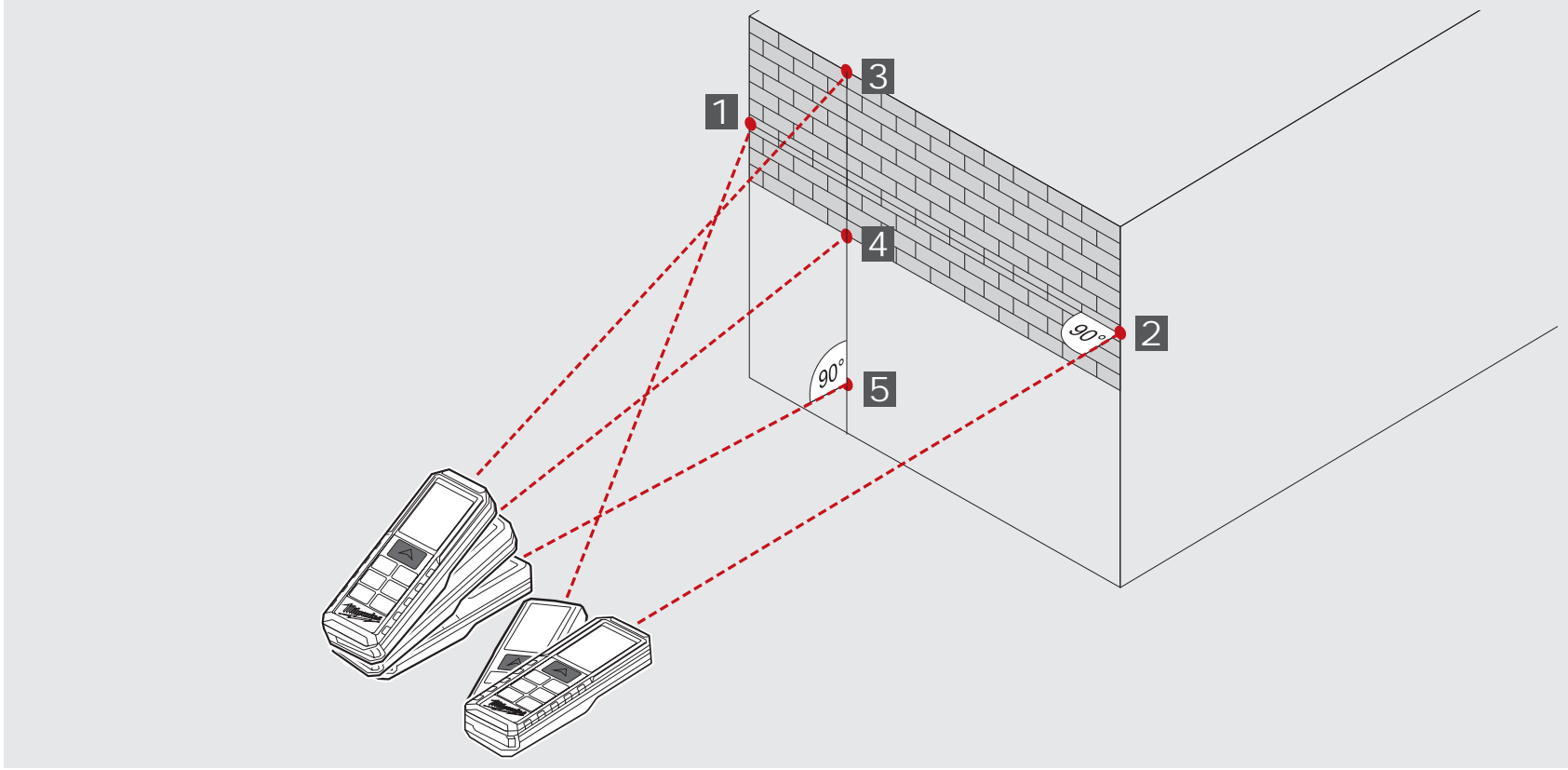
<p>0</p> 	<p>1</p> 	<p>2</p> 	<p>3</p> 	<p>4</p> 
				



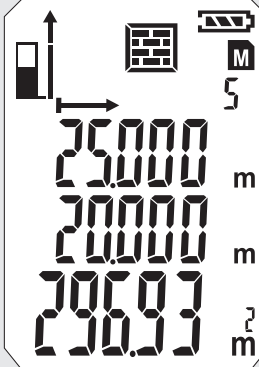

5





TEMPORIZADOR

Mediante el temporizador se puede activar la medición de forma retardada, por ej. para posicionar un componente en el haz de medición.

Pulsar la tecla 

- Aparece el símbolo.
- Pulsando la tecla  el temporizador se puede ajustar entre 3 y 15 segundos.

Pulsar la tecla 

- Los segundos se van descontando hasta efectuar la medición.
- Al llegar a 0 se activa la medición.

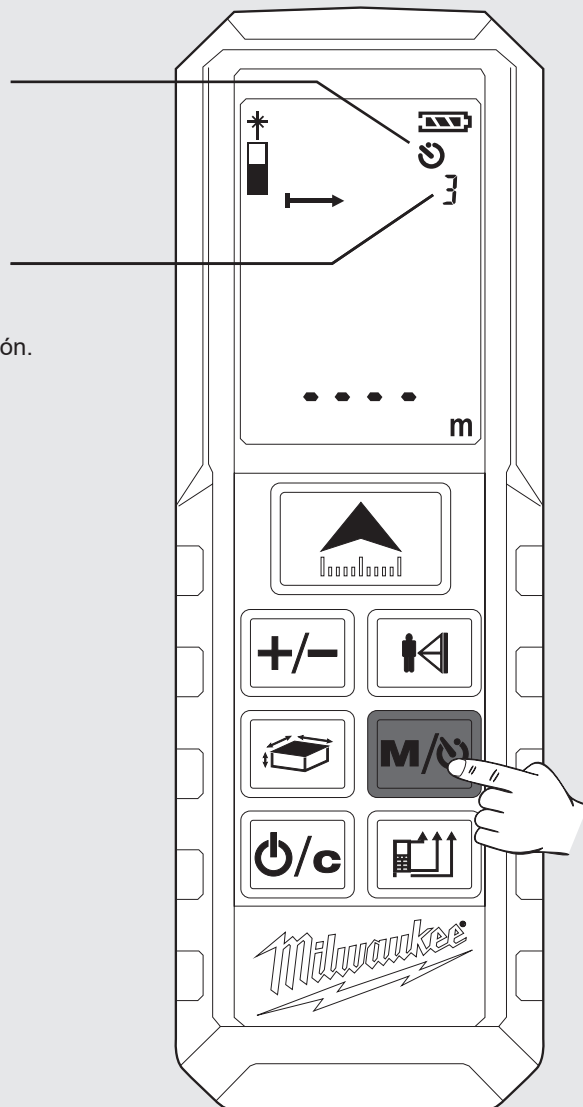

MEMORIA

Los valores de medición se van guardando automáticamente y de manera progresiva en la memoria.

Los valores guardados se pueden visualizar con la tecla 

Pulsar la tecla  2 segundos.

- Aparece el símbolo y la posición de memoria.
- Se visualiza la magnitud de medición correspondiente.
- El valor guardado se visualiza en la línea principal.
- Visualizar los valores guardados, pulsando repetidamente la tecla .

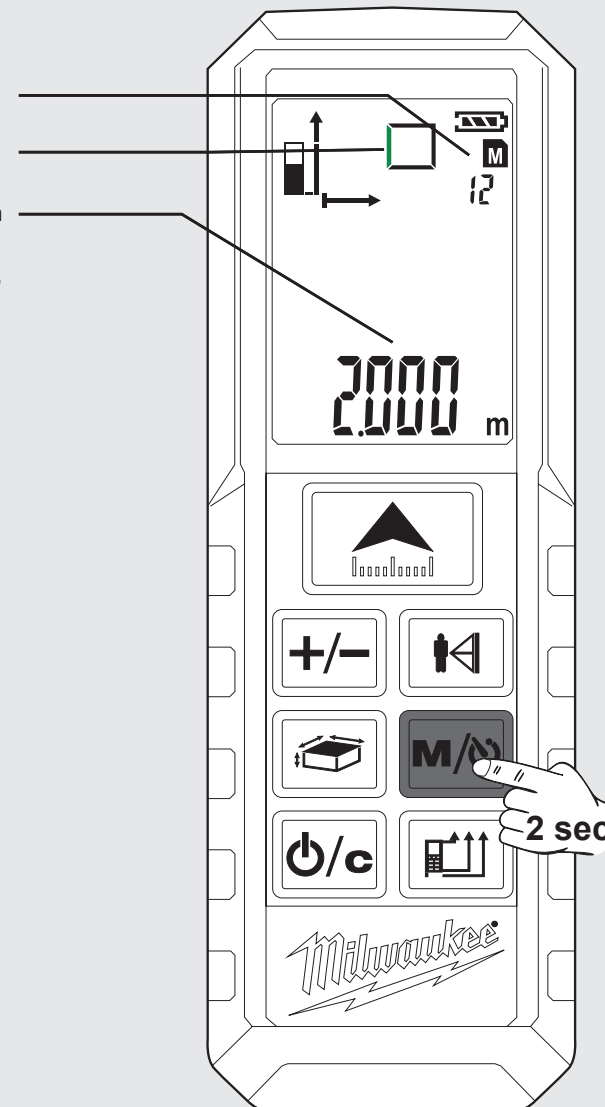

FUNCIONAMIENTO BÁSICO PONIENDO COMO EJEMPLO UNA MEDICIÓN DE SUPERFICIES (1)

1 Encender

Pulsar la tecla  .
⚠ ¡Atención! ¡El rayo láser está encendido!
¡No dirigir hacia personas!

El símbolo del láser parpadea (parpadea en color verde).

2 Seleccionar el plano de medición

Ajuste estándar después de la activación: atrás
 Pulsar 1 vez-> punta de ángulos
 Pulsar 2 veces -> delante
 Pulsar 3 veces -> atrás

El símbolo se visualiza.

3 Seleccionar la función

Después de la activación, el aparato se encuentra posicionado siempre en medición de longitud.
 Pulsar 1 vez  -> medición de superficies

- El símbolo aparece.
 - La magnitud de medición parpadea (parpadea en color verde)

4 Medir la longitud

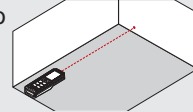
Orientar el aparato y pulsar la tecla  

- El valor medido aparece brevemente en la línea principal.
 - Después de haber transcurrido 1 segundo, el valor medido salta a la línea situada directamente encima.
 - El valor medido se guarda en la memoria con el número consecutivo.
 - La segunda magnitud de medición parpadea. El aparato está listo para la medición del segundo valor.

5 Medir la anchura

Orientar el aparato y pulsar la tecla  

- El valor medido aparece brevemente en la línea principal.
 - Después de haber transcurrido 1 segundo, el valor medido salta a la línea situada directamente encima.
 - El valor medido se guarda en la memoria con el número consecutivo.
 - El resultado se visualiza en la línea principal y se guarda en la memoria con el número consecutivo.

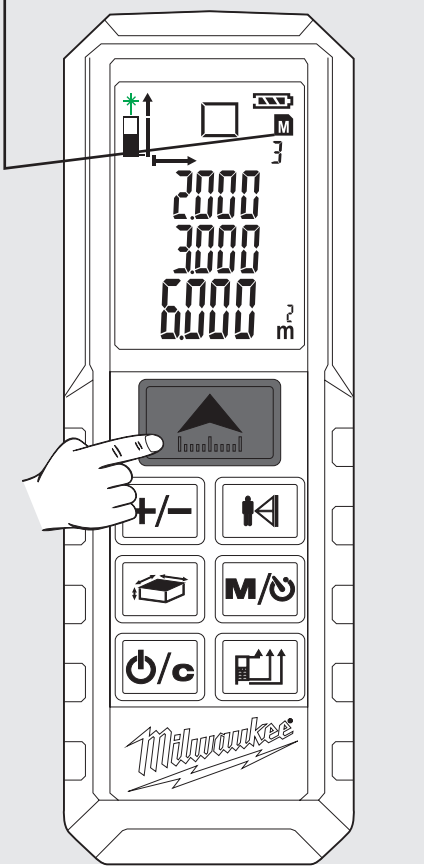
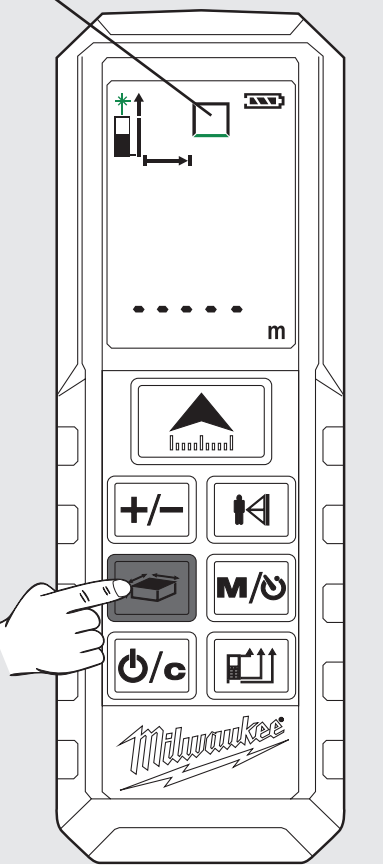
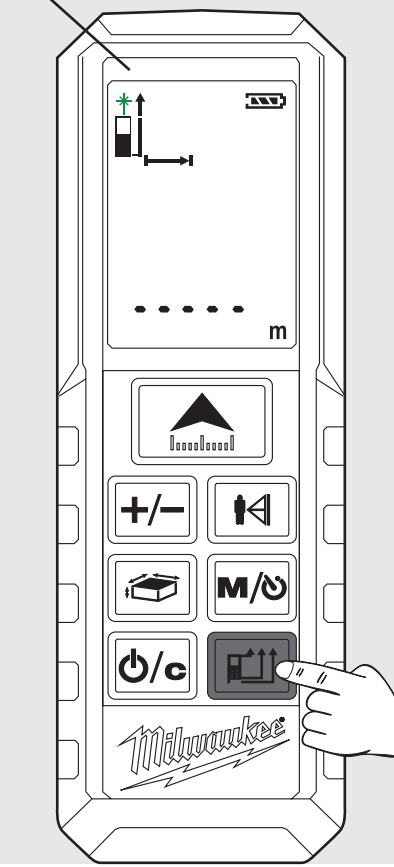
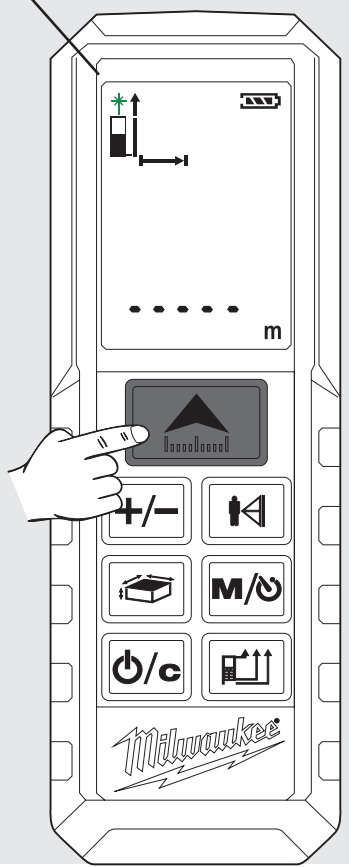

FUNCIONAMIENTO BÁSICO PONIENDO COMO EJEMPLO UNA MEDICIÓN DE SUPERFICIES (2)

6 Visualizar los valores guardados

Pulsar la tecla **M/0** 2 segundos.
Pulsar repetidamente la tecla **M/0**.

7 Abandonar la memoria

Pulsar la tecla **0/c**

8 Apagar

Pulsar la tecla **0/c** durante 2 segundos
(Antes se debe abandonar la memoria).

- Los valores guardados se visualizan en la línea principal.
- El símbolo correspondiente aparece y la magnitud de medición parpadea (parpadea en color verde).

- El aparato se apaga.
- Si durante un lapso de tiempo de 3 minutos no se presiona ninguna tecla, el aparato se apaga automáticamente.

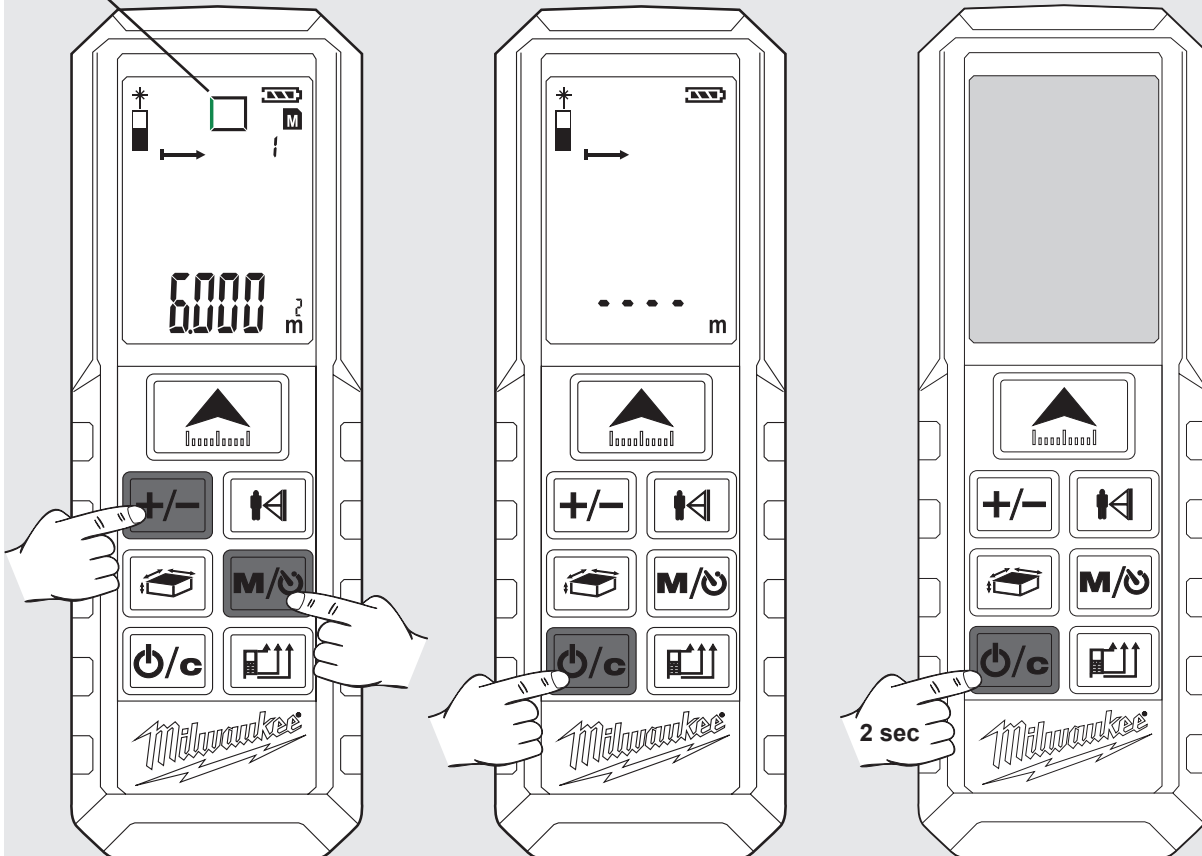

CONTEÚDO

Instruções de Segurança Importantes.....	1
Características técnicas	2
Utilização autorizada	2
Tabela de códigos de erro	2
Vista geral.....	3
Trocar a bateria	4
Pino de canto.....	4
Clip de cinto.....	4
Tecla de função, pitágoras, referência de medição	5
Medição de comprimento simples	6
Medição contínua / Medição mínimo-máximo	7
Medição de adição / subtração.....	8
Medição da área.....	9
Medição do volume	10
Medição indirecta (pitágoras 1)	11
Medição indirecta (pitágoras 2)	12
Medição indirecta (pitágoras 3)	13
Medição da área da parede (cenário 1)	14
Medição da área da parede (cenário 2)	15
Temporizador.....	16
Memória.....	16
Modo de funcionamento básico no exemplo de uma medição da área (1).....	17
Modo de funcionamento básico no exemplo de uma medição da área (2).....	18

INSTRUÇÕES DE SEGURANÇA IMPORTANTES



Não utilizar o produto, antes de ler atentamente as Instruções de Segurança e o Manual de Operação incluídos no CD-ROM fornecido com o produto.

Classificação do laser

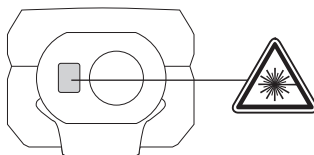

ATENÇÃO:

Produto laser de Classe 2, de acordo com a Norma EN60825-1:2014.



λ 650 nm P<1 mW

Aviso:

Não olhar directamente para o feixe de luz laser. O raio laser pode queimar os olhos e levar a uma cegueira temporária.

Não olhar directamente para o feixe de luz laser, nem apontar o feixe de luz directamente para as outras pessoas.

Não apontar o feixe de luz laser para outras pessoas.

Aviso:

Não opere o aparelho de laser na proximidade de crianças e não deixe crianças usar o aparelho de laser.

Atenção! Uma superfície reflectora pode reflectar o raio laser ao operador ou a terceiros.

Manter as extremidades a uma distância segura das peças móveis.

Efectuar medições de teste frequentes. Especialmente, antes, durante ou depois de medições importantes.

Em caso de anomalia no funcionamento, queda ou utilização incorrecta do produto, ou se este tiver sido modificado, existe o risco de as medições efectuadas serem incorrectas.

Aviso: A utilização de elementos de controlo, ajustes ou a execução de processos não determinados no manual pode levar a uma exposição à radiação perigosa.

O medidor a laser tem uma área de utilização limitada. (Veja a secção "Dados técnicos). Tentativas de medir fora da área máxima e mínima levam medições inexactas. A utilização em caso de condições adversas, como muito quente, muito frio, luz do sol muito clara, chuva, neve, névoa ou outras condições que prejudiquem a vista pode levar a medições inexactas.

Se o medidor a laser for levado de um ambiente quente a um ambiente frio (ou vice-versa), aguarde até o aparelho se adaptar à temperatura ambiente nova.

Guarde o medidor a laser no interior, proteja o aparelho contra choque, vibrações ou temperaturas extremas.

Proteja o medidor a laser contra pó, humidade e alta humidade do ar. Isto poderia destruir componentes internos ou influenciar a precisão.

Não use detergentes ou solventes agressivos. Só limpe com um pano limpo e macio.

Evite choques duros ou a queda do medidor a laser. A precisão do aparelho deve ser verificada depois dele cair ou ter sido exposto a outros esforços mecânicos.

Reparações necessárias neste aparelho de laser só devem ser executadas pelo pessoal especializado e autorizado.

Não utilizar o produto em áreas com risco de explosão ou ambientes agressivos.

Para carregar as baterias, utilizar apenas carregadores recomendados pelo fabricante.



Resíduos de pilhas, resíduos de equipamentos eléctricos e electrónicos não devem ser descartados com o lixo doméstico. Resíduos de pilhas, resíduos de equipamentos eléctricos e electrónicos devem ser recolhidos e descartados separadamente.

Remova os resíduos de pilhas, os resíduos de acumuladores e as luzes antes de descartar os equipamentos.

Informe-se sobre os centros de reciclagem e os postos de coleta nas autoridades locais ou no seu vendedor autorizado.

Dependendo dos regulamentos locais, os retalhistas podem ser obrigados a retomar gratuitamente os resíduos de pilhas e os resíduos de equipamentos eléctricos e electrónicos.

Contribua a reduzir as necessidades de matérias-primas, reutilizando e reciclando os seus resíduos de pilhas e os seus resíduos de equipamentos eléctricos e electrónicos.

Resíduos de pilhas (particularmente pilhas de íon lítio), resíduos de equipamentos eléctricos e electrónicos contêm materiais valiosos e reutilizáveis que podem ter efeitos negativos para o meio ambiente e a sua saúde.

Apague eventuais dados pessoais existentes no seu resíduo de equipamento antes de descartá-lo.



Marca de conformidade europeia



Marca de conformidade britânica



Marca de Conformidade Ucraniana



Marca de Conformidade Eurasiática

CARACTERÍSTICAS TÉCNICAS

Classe de protecção	IP54 (protegido contra pó e salpicos de água)
Lente	14 mm
Foco	35 mm
Área de medição máx.	50 metros (tolerância: 55m)
Área de medição mín.	0,05 metros
Precisão absoluta @ < 10m	± 1,5 mm (máx.)
Precisão de repetição @ < 10m	± 1,5 mm (típica máx. 2σ)
Precisão de repetição @ > 10m	aumento ± 0,25 mm / metros (típica máx. 2σ)
Tempo de medição	0,5 s
Tela tipo	LCD (22,7 mm x 31 mm)
Alimentação eléctrica	AAA 2x (bateria alcalina)
Vida útil da bateria	10000 (medição individual)
Potência de saída do laser	0,6 mW ~ 0,95 mW (classe 2, 650nm)
Tamanho do ponto do laser	25 x 30 mm @ 16 m (máx.)
Classe de lase	2r
Tipo de laser	650 nm, < 1 mW
Raio laser ângulo vertical	+1 grau
Raio laser ângulo horizontal	±1 grau
Desligamento automático do aparelho	180 segundos
Desligamento automático do laser	30 segundos
Gama de temperatura de trabalho	-10°C a +50°C
Gama de temperatura de armazenamento	-25°C a +70°C
Peso sem bateria	80 g

UTILIZAÇÃO AUTORIZADA

O medidor a laser destina-se a medir distâncias e inclinações.

Não use este produto de outra maneira sem ser a normal para o qual foi concebido.

TABELA DE CÓDIGOS DE ERRO

Código	Descrição	Solução
Err01	Fora da área de medição	Faça a medição na área prevista.
Err02	Sinal reflectido muito fraco	Selecione uma superfície melhor.
Err03	Fora da gama de indicação (valor máx.: 99.999) p. ex. é o resultado de área ou volume fora da gama de indicação	Verifique, se os valores ou passos são correctos.
Err04	Erro no cálculo de pitágoras#tsab#Verifique, se os valores e passos são corretos.	Check and verify values and steps are correct
Err05	Bateria a esgotar	Coloque baterias novas.
Err06	Fora da gama de temperatura de serviço	Faça a medição na gama de temperatura prevista.
Err07	Luz ambiente muito clara	Escureça a área de destino.

Pitágoras
Diferença de altura

Referência de medição

Medição do comprimento

Mínimo / Máximo para a medição contínua

Adição / Subtração

LIGAR / MEDIR

- ▶ Ligar
- ▶ Medir
- ▶ Medição contínua (pressionar por 2 seg.)
Função mín. / máx.

ADIÇÃO / SUBTRACÇÃO

- ▶ Adicionar o valor
- ▶ Navegar na memória

ÁREA / VOLUME

- ▶ Área (pressionar 1x)
- ▶ Volume (pressionar 2x)
- ▶ Medição indirecta da área (pressionar 3x / 4x)

LIGAR

- ▶ Ligar
- ▶ Desligar (pressionar por 2 seg)
- ▶ Resetar

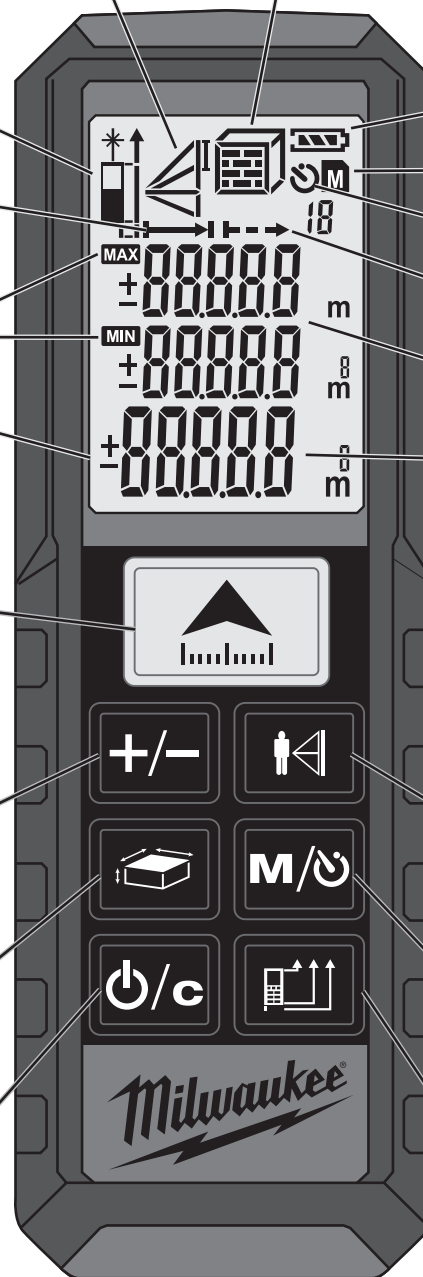

Área / Volume
Medição indirecta da área

Status da bateria

Memória

Temporizador

Medição contínua

Valores intermediários

Total

PITÁGORAS

- ▶ Pitágoras 1 (pressionar 1x)
- ▶ Pitágoras 2 (pressionar 2x)
- ▶ Pitágoras 3 (pressionar 3x)

MEMÓRIA

- ▶ Temporizador 3-15 seg (pressionar 1x)
- ▶ Memória 1-20 (pressionar 1x por 2 seg)
- ▶ Consultar os valores memorizados (pressionar várias vezes)

MUDAR A REFERÊNCIA DE MEDIÇÃO

- ▶ Frente
- ▶ Atrás
- ▶ Pino de canto

TROCAR A BATERIA

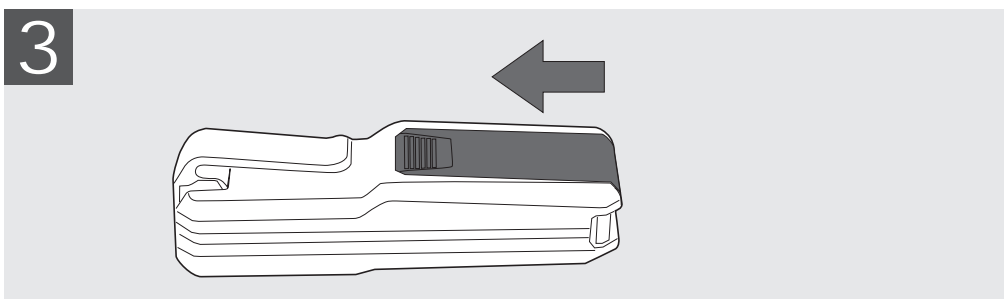
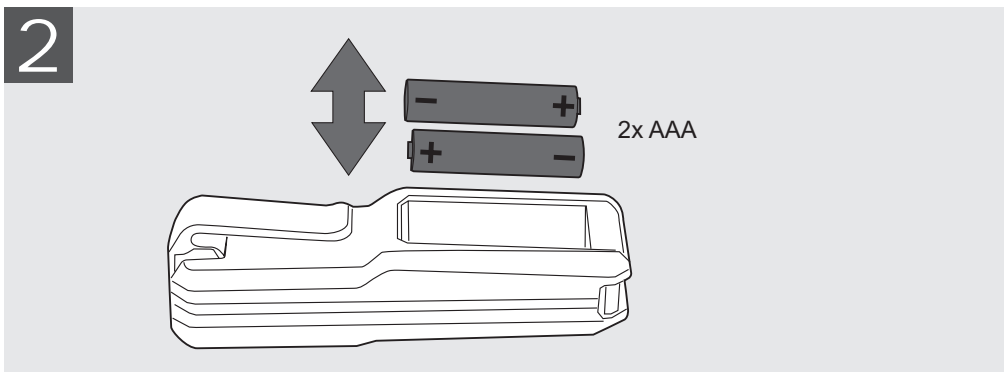
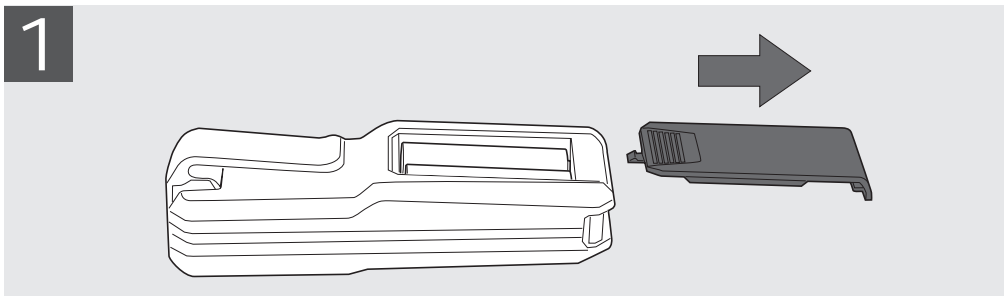
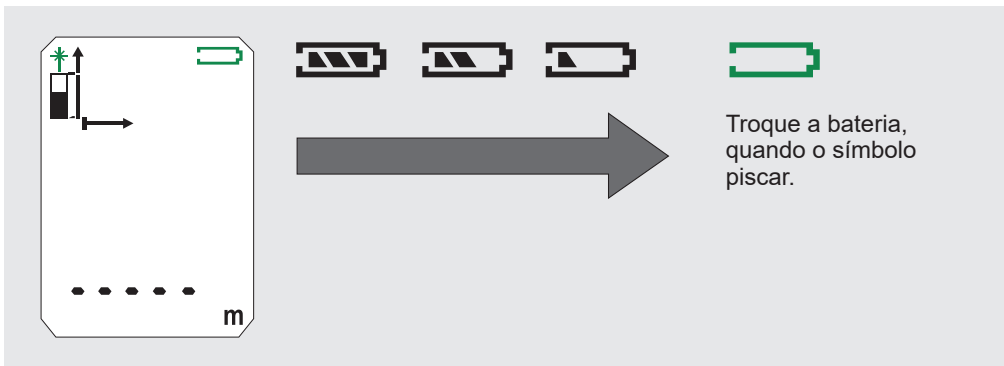

PINO DE CANTO

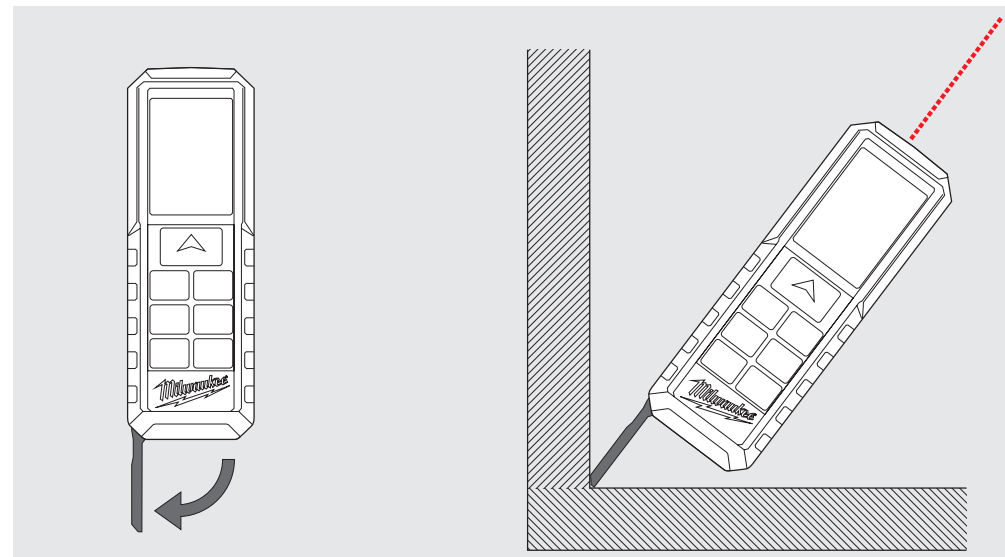

CLIP DE CINTO

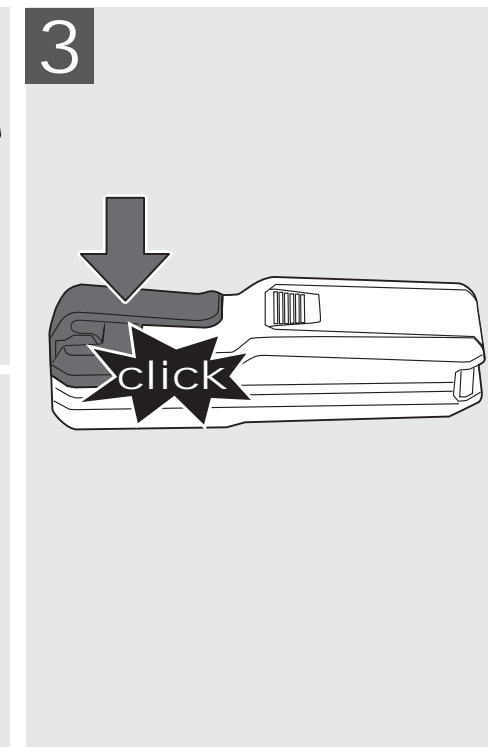
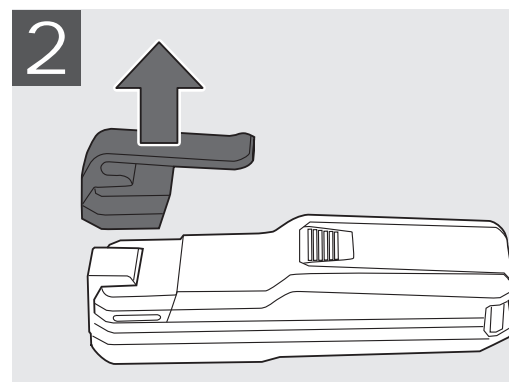
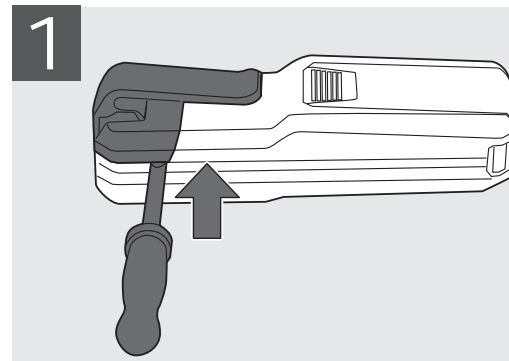

TECLA DE FUNÇÃO, PITÁGORAS, REFERÊNCIA DE MEDIÇÃO

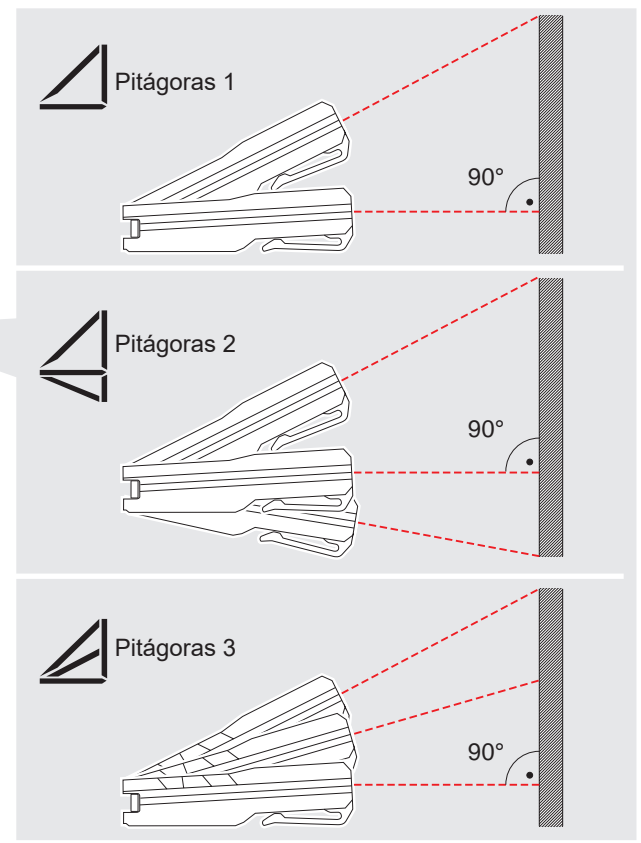
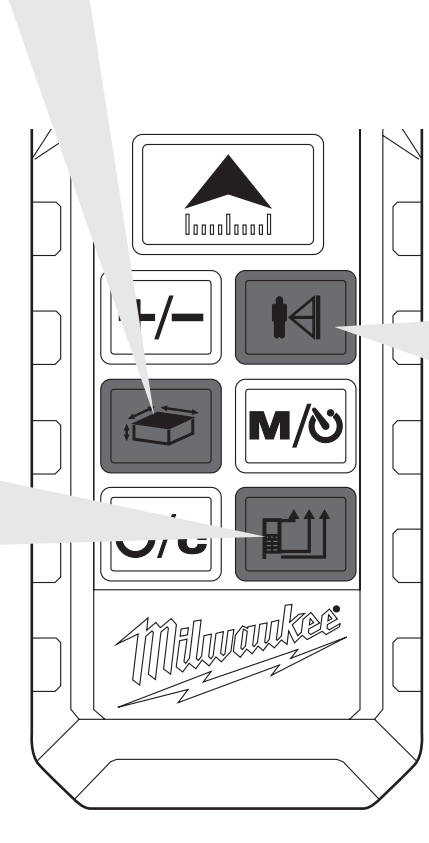
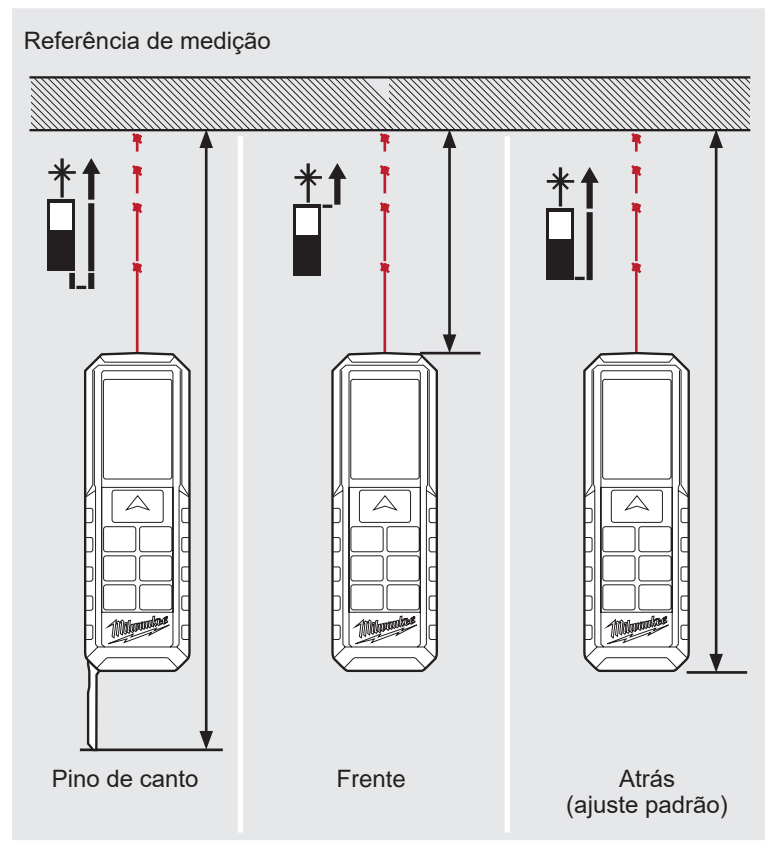
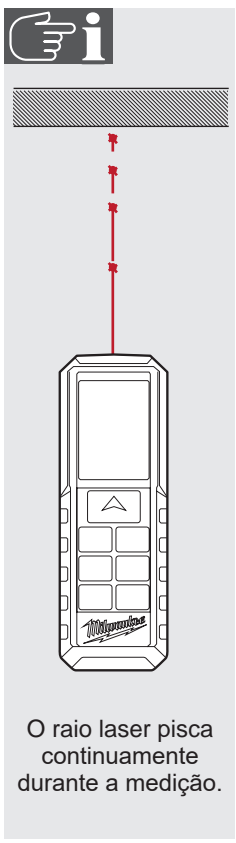
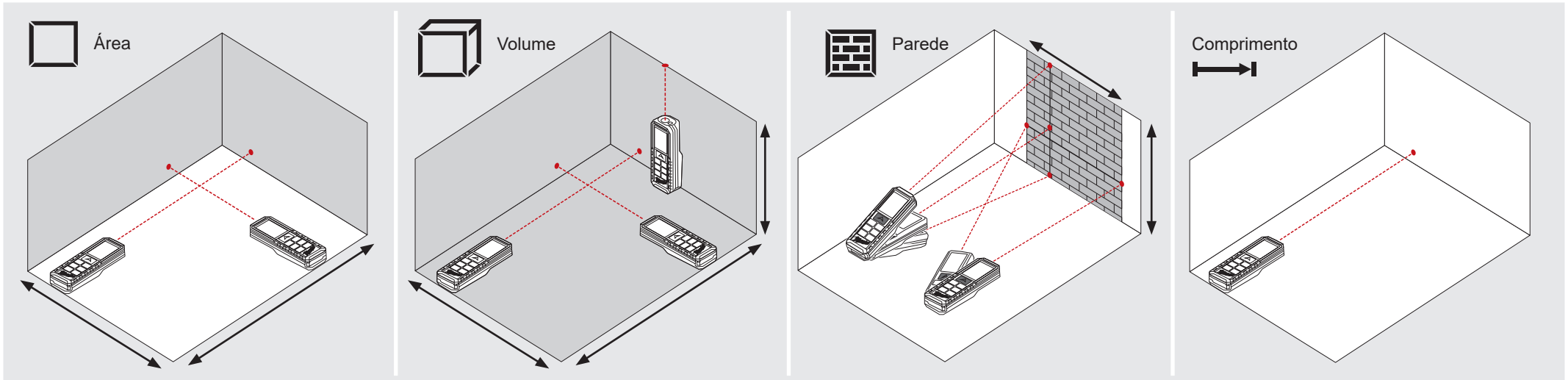

MEDIÇÃO DE COMPRIMENTO SIMPLES

0

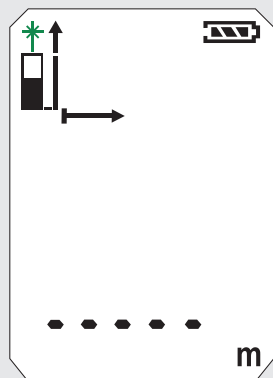

1

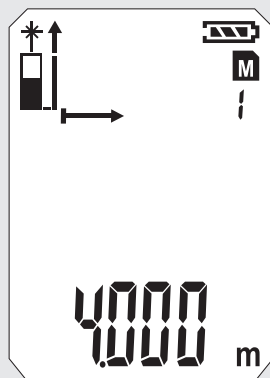

2

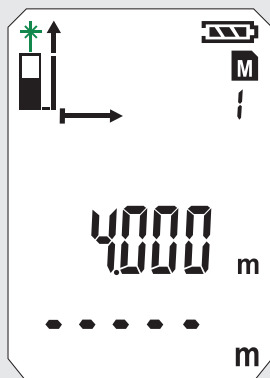

3

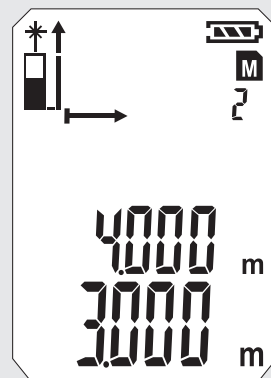

4

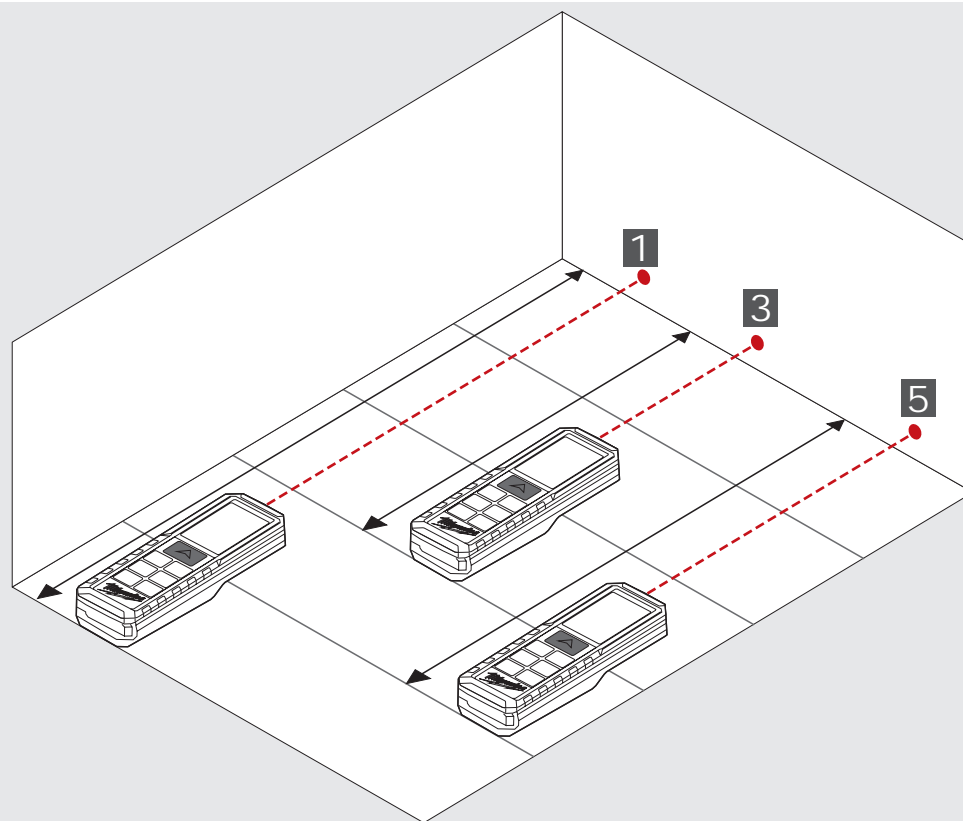
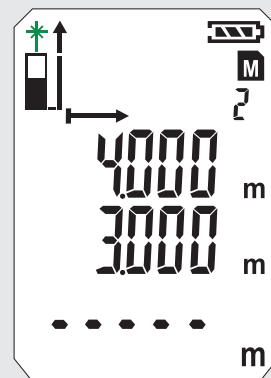

5

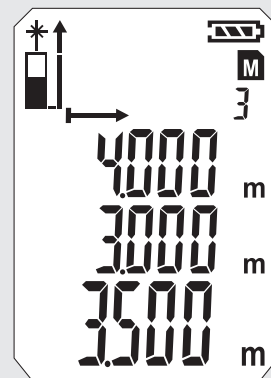

MEDIÇÃO CONTÍNUA / MEDIÇÃO MÍNIMO-MÁXIMO

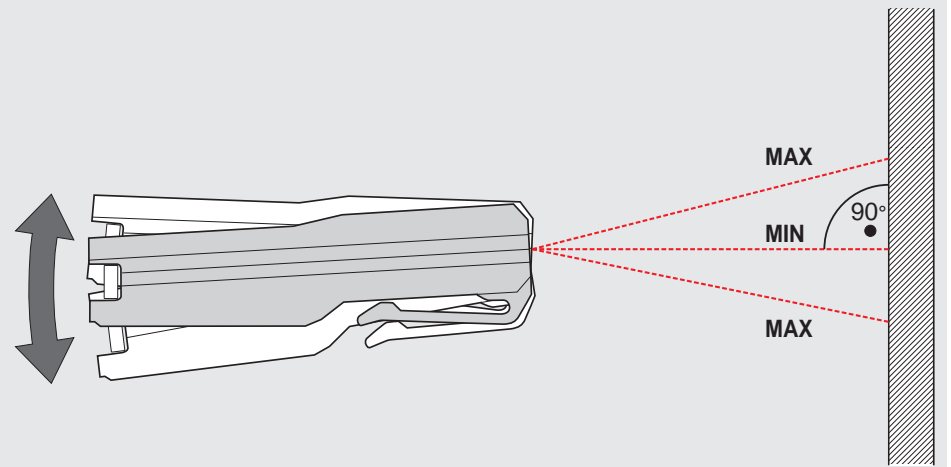
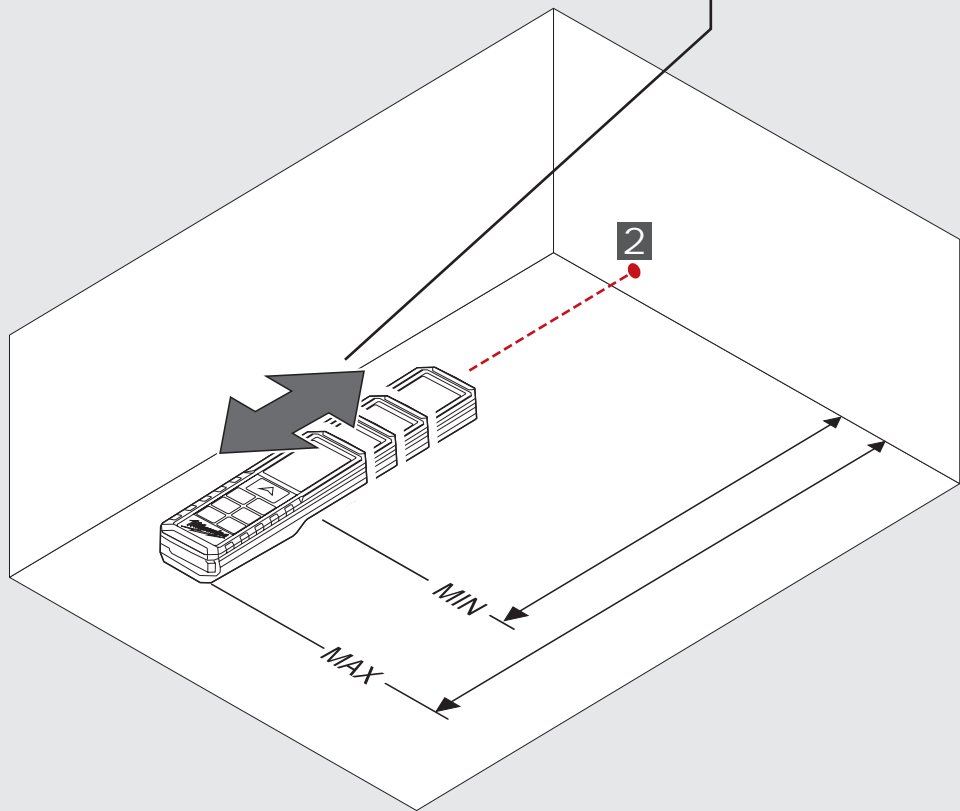
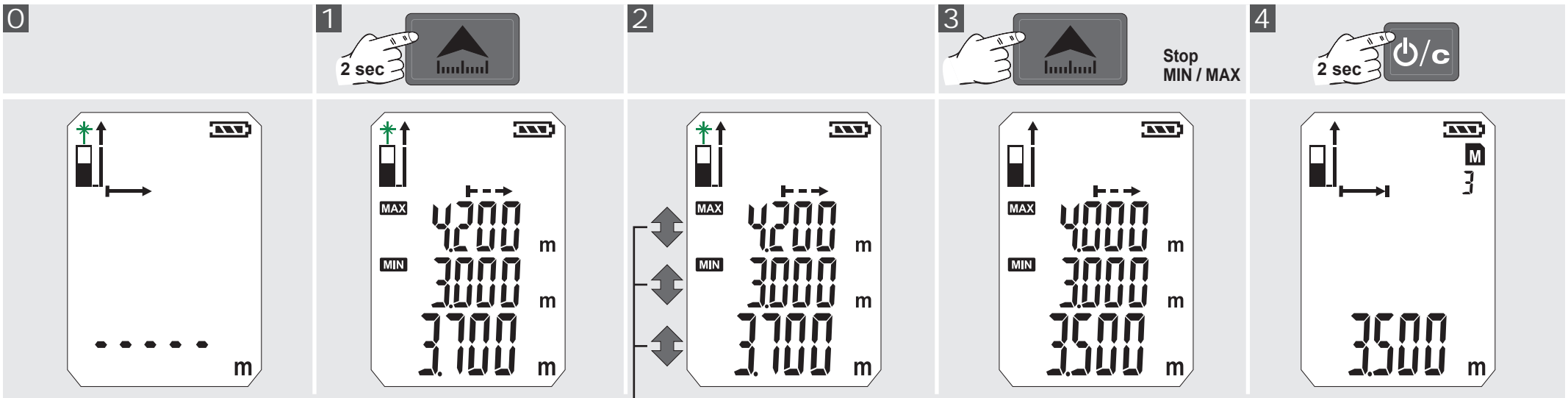

0

1

2

3

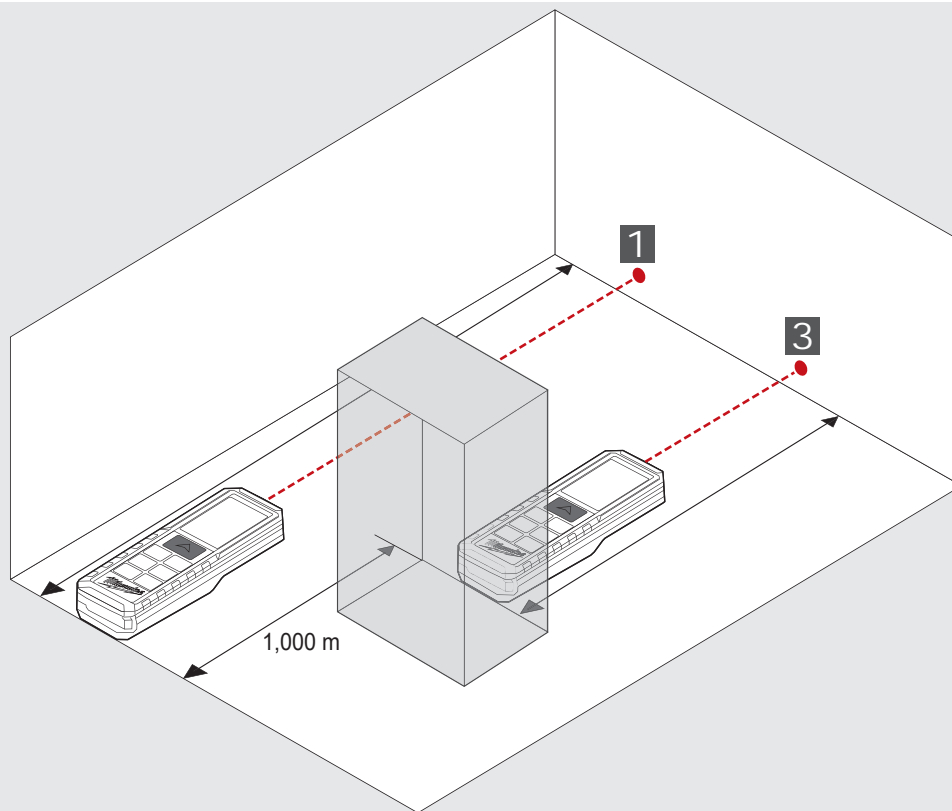
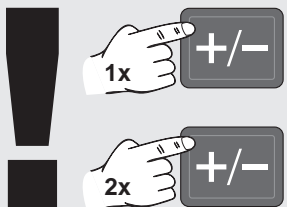
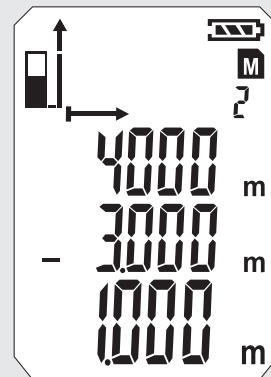
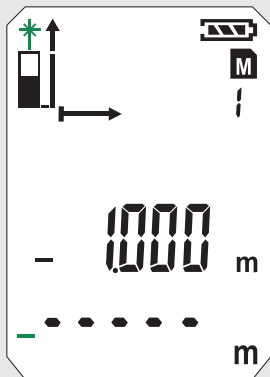
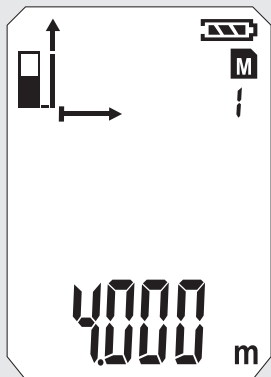
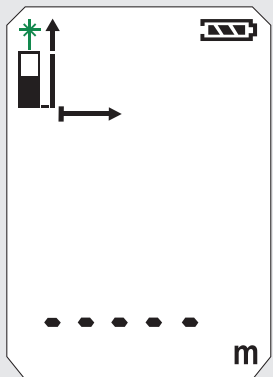

MEDIÇÃO DA ÁREA

0

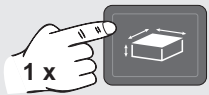

1



2

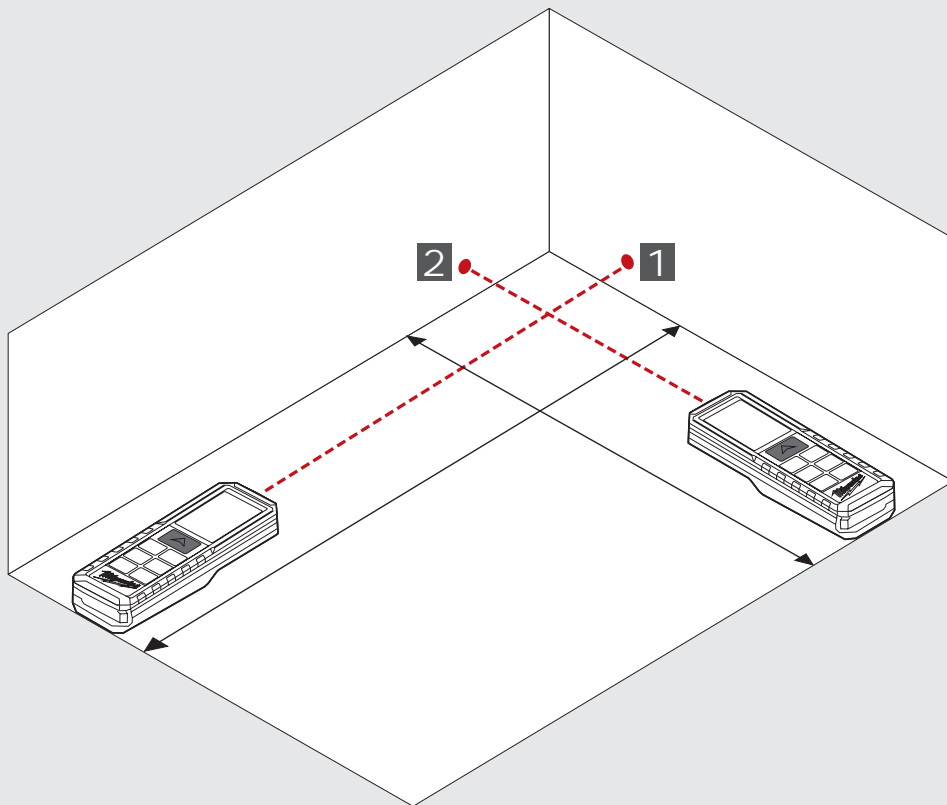
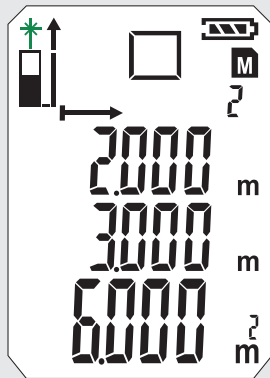
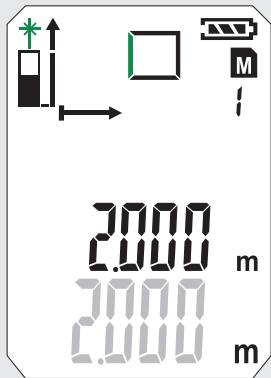
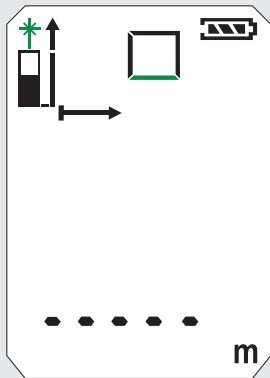

MEDIÇÃO DO VOLUME

0



1



2



3

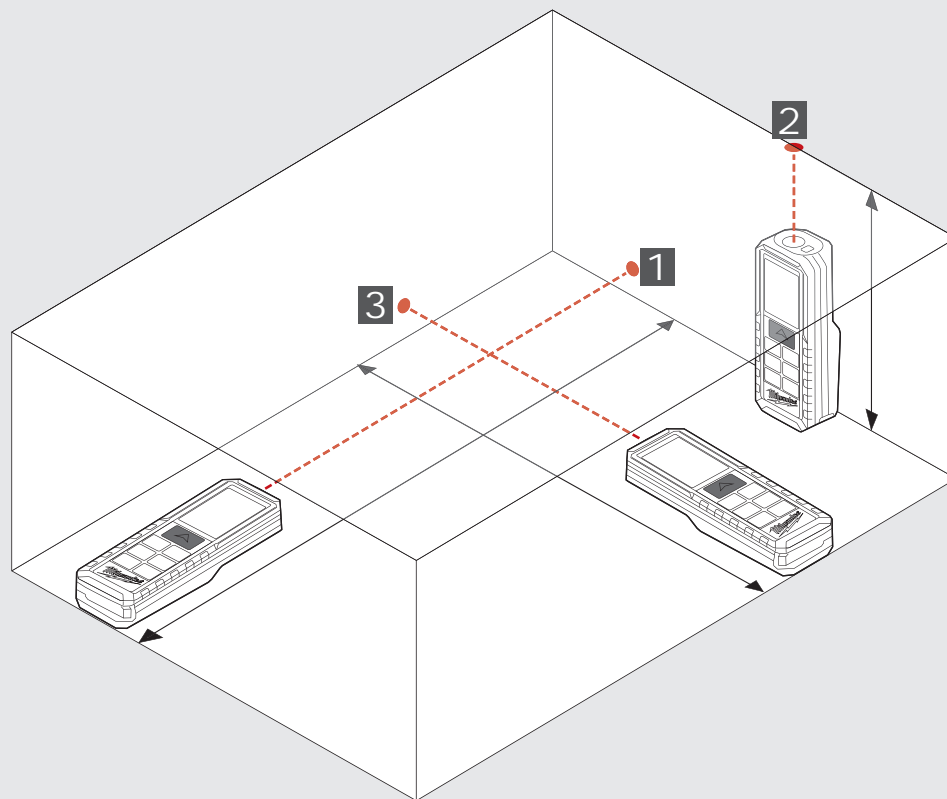
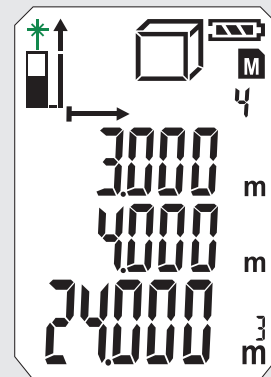
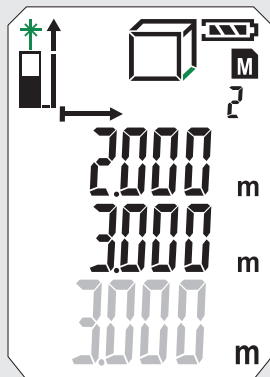
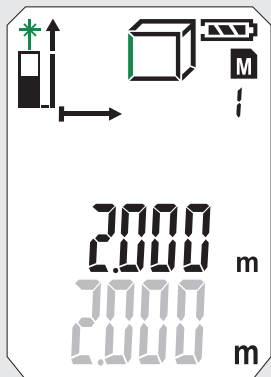
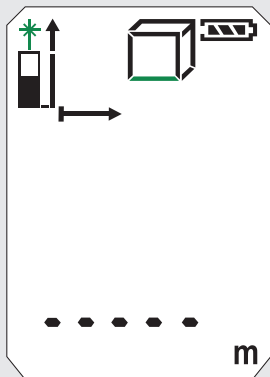

MEDIÇÃO INDIRECTA (PITÁGORAS 1)

0



1



2

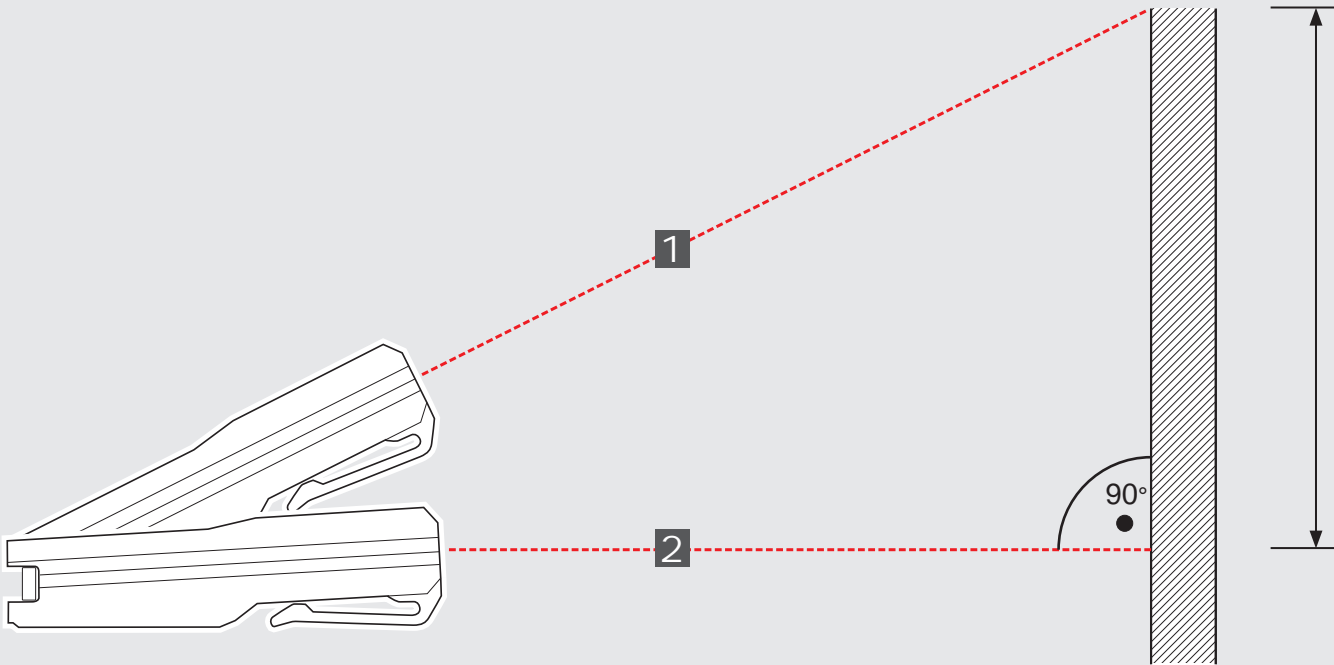
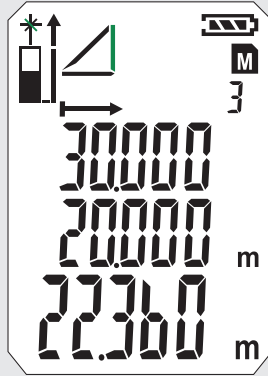
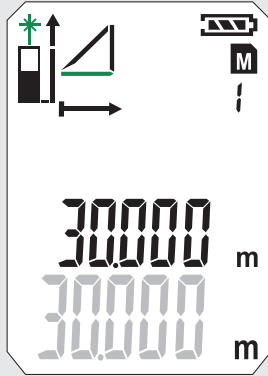
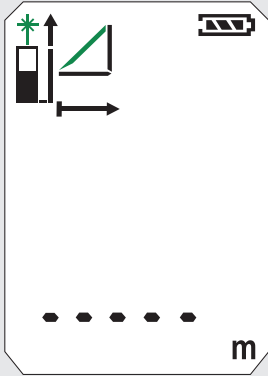

MEDIÇÃO INDIRECTA (PITÁGORAS 2)

0



2 x

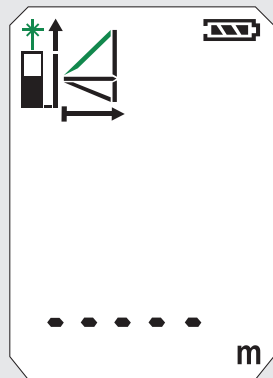

1

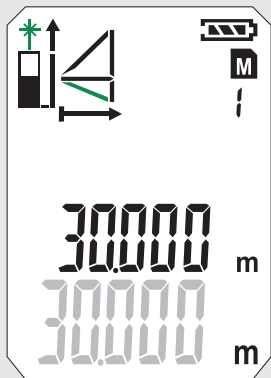

2

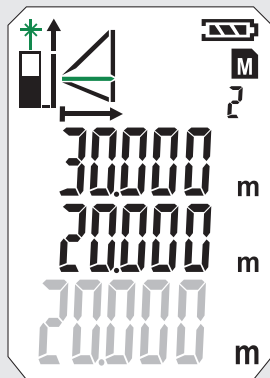

3

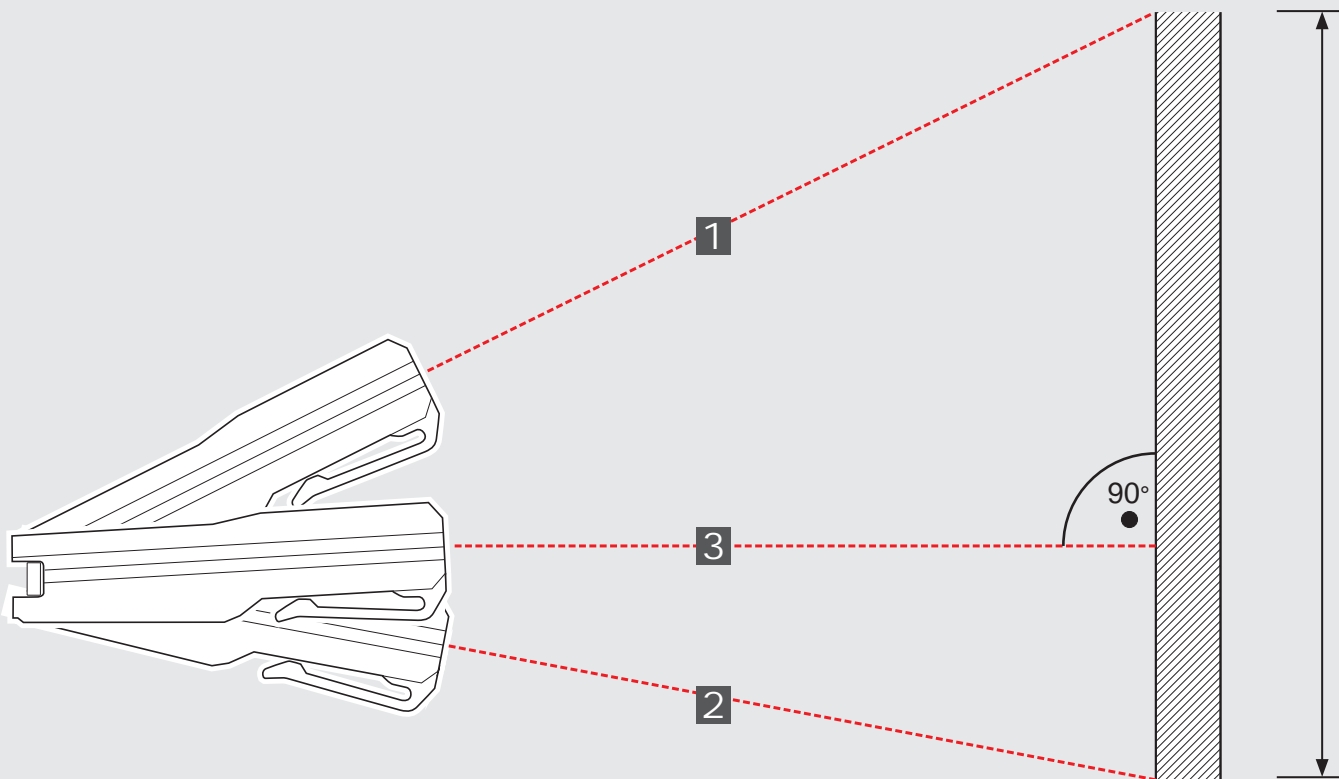
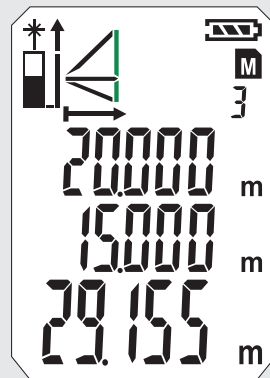

MEDIÇÃO INDIRECTA (PITÁGORAS 3)

1



2







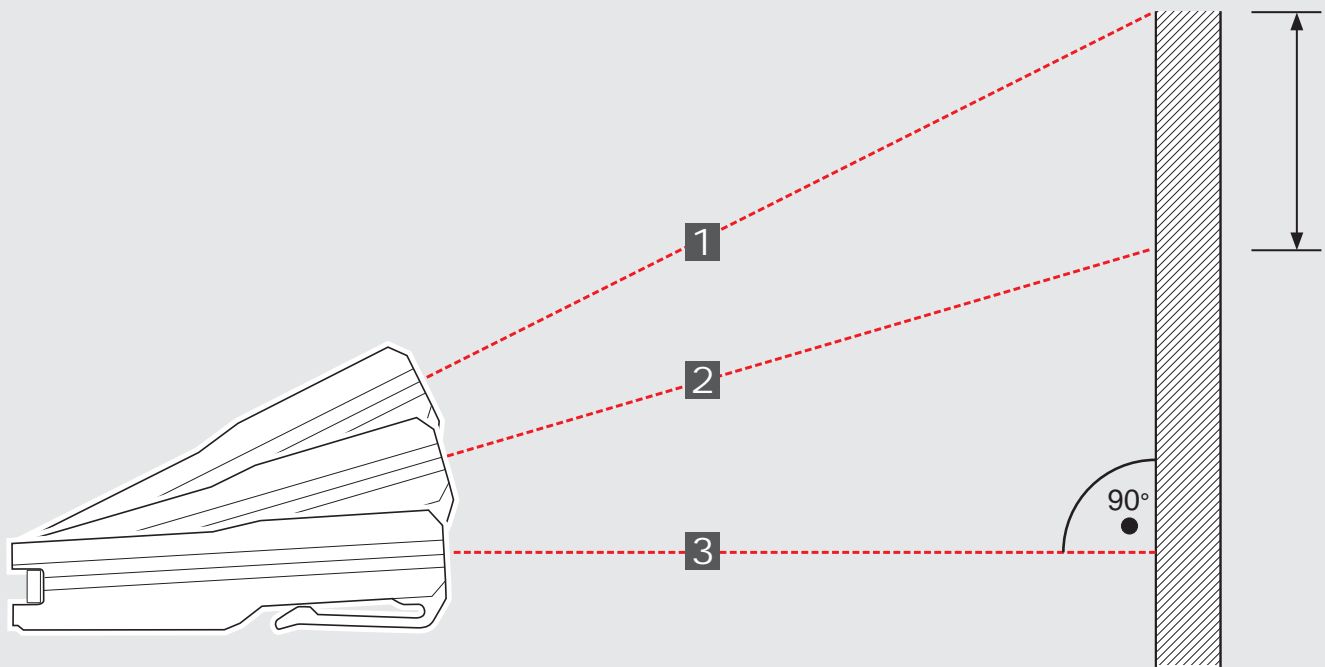
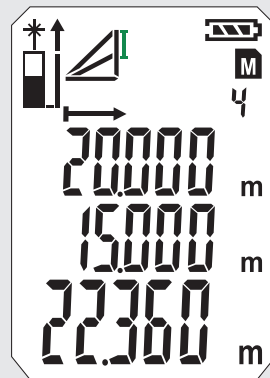
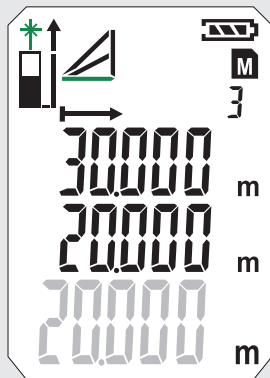
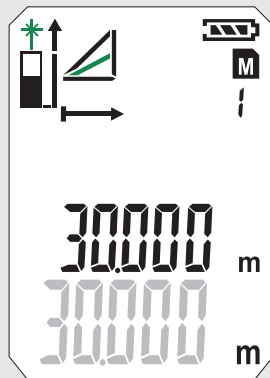
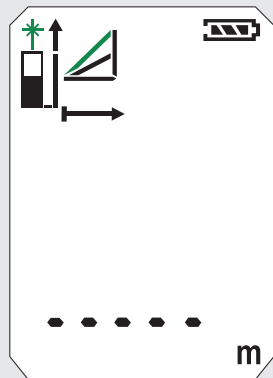

3



4

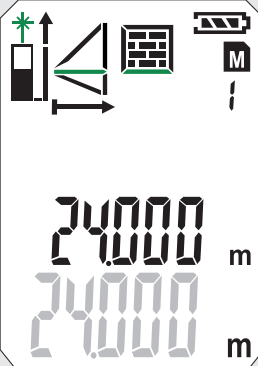
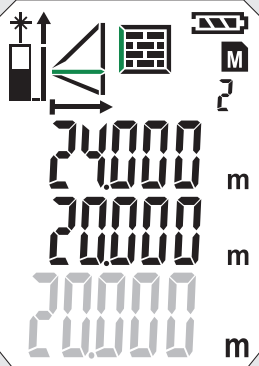
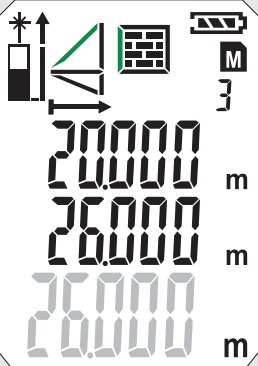
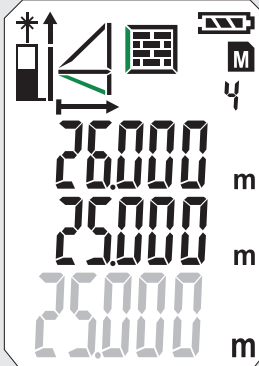

MEDIÇÃO DA ÁREA DA PAREDE (CENÁRIO 1)

<p>0</p> 	<p>1</p> 	<p>2</p> 	<p>3</p> 	<p>4</p> 
				

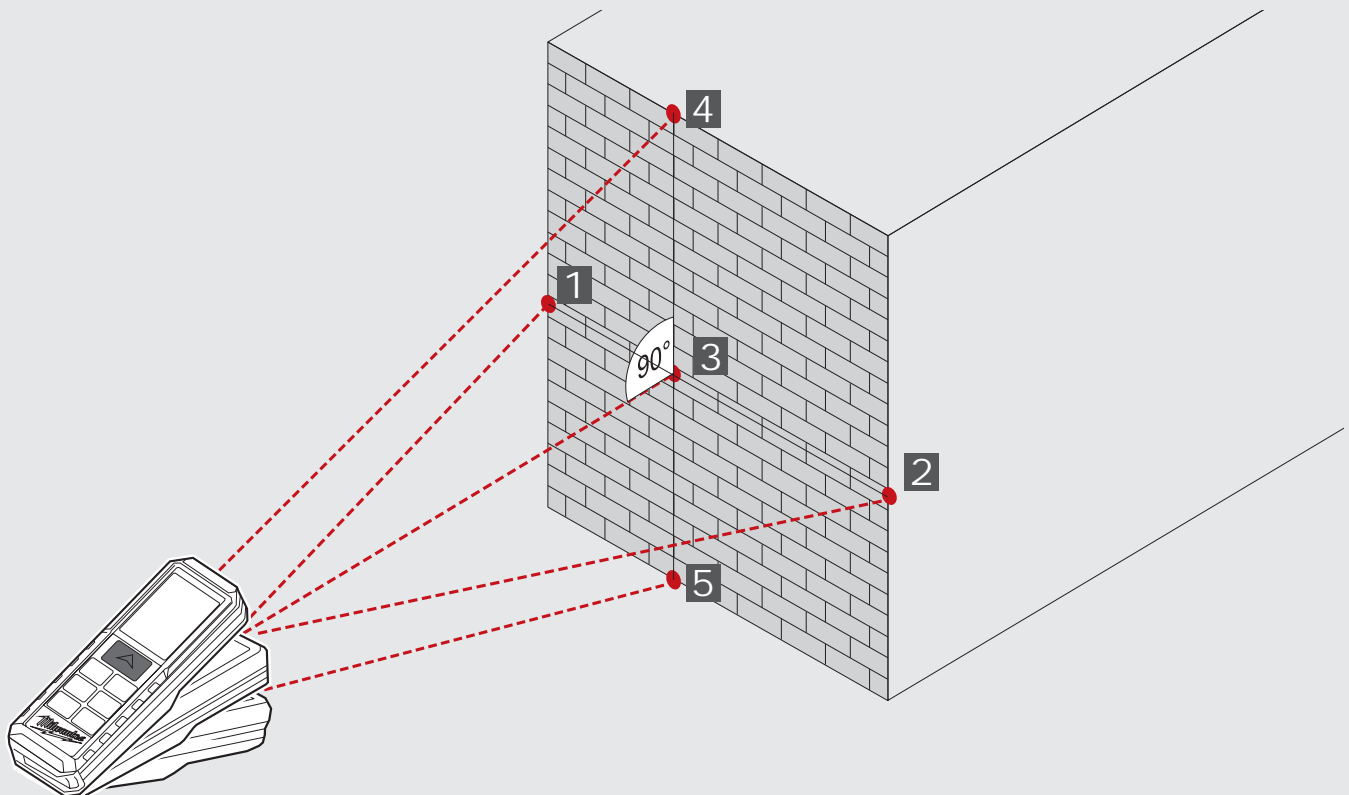



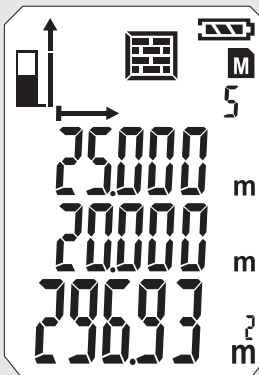

5



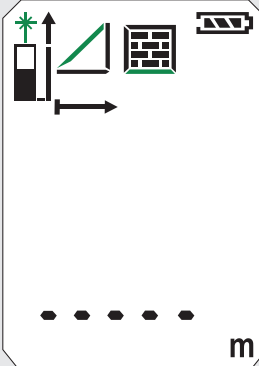
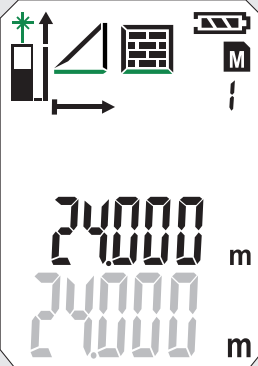
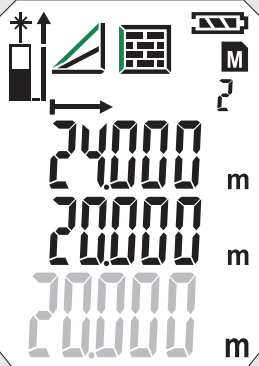
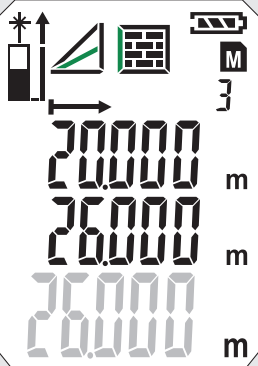
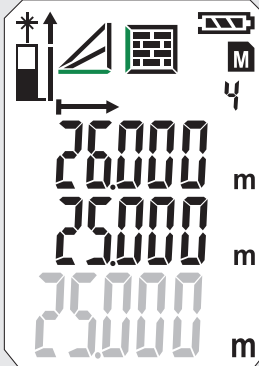

MEDIÇÃO DA ÁREA DA PAREDE (CENÁRIO 2)

<p>0</p> 	<p>1</p> 	<p>2</p> 	<p>3</p> 	<p>4</p> 
				

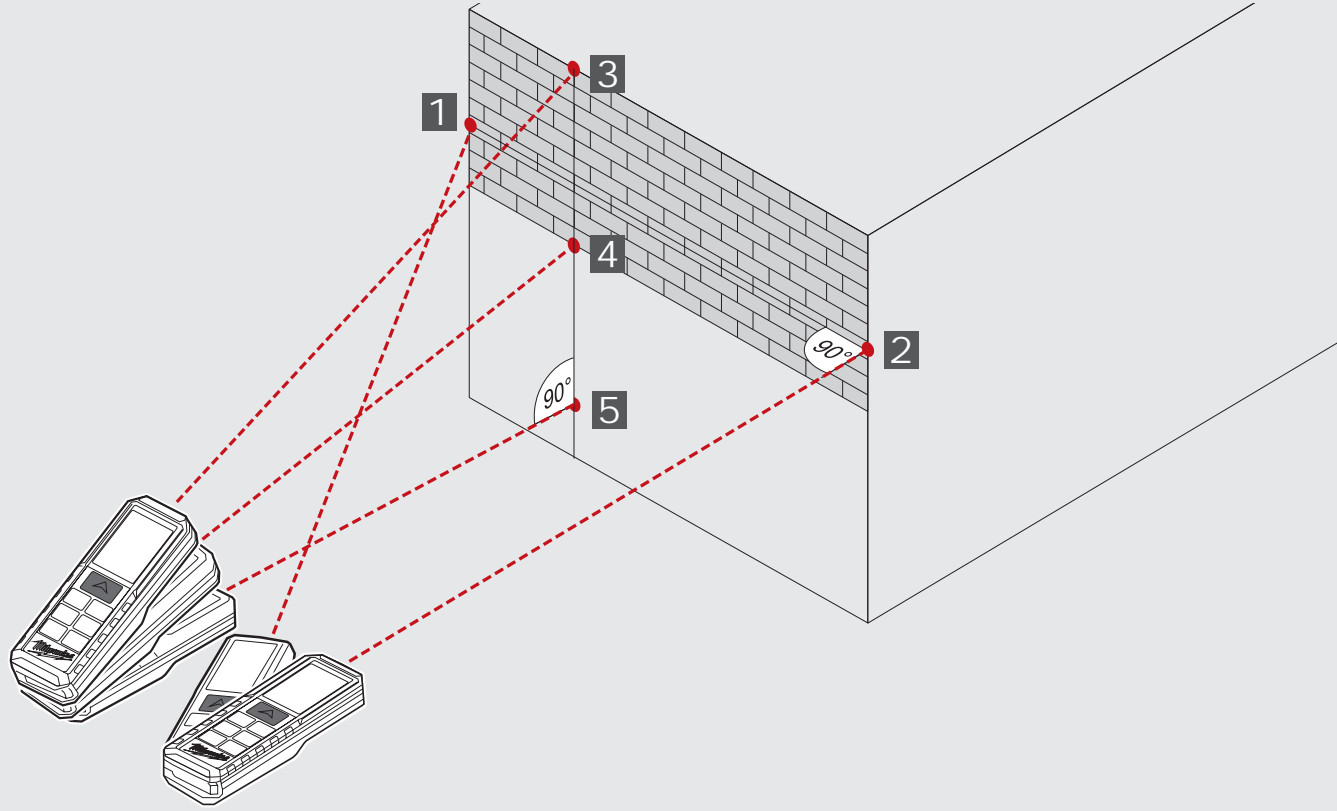

5



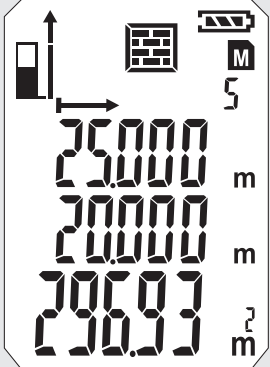



TEMPORIZADOR

Com o temporizador a medição pode ser activada com retardo, p. ex. para posicionar um componente no raio de medição.

Pressione a tecla 

- O símbolo aparece
Pressionando a tecla  o temporizador pode ser ajustado entre 3 e 15 seg

Pressione a tecla 

- São contados os segundos até à medição.
- Ao chegar a 0, a medição é activada.

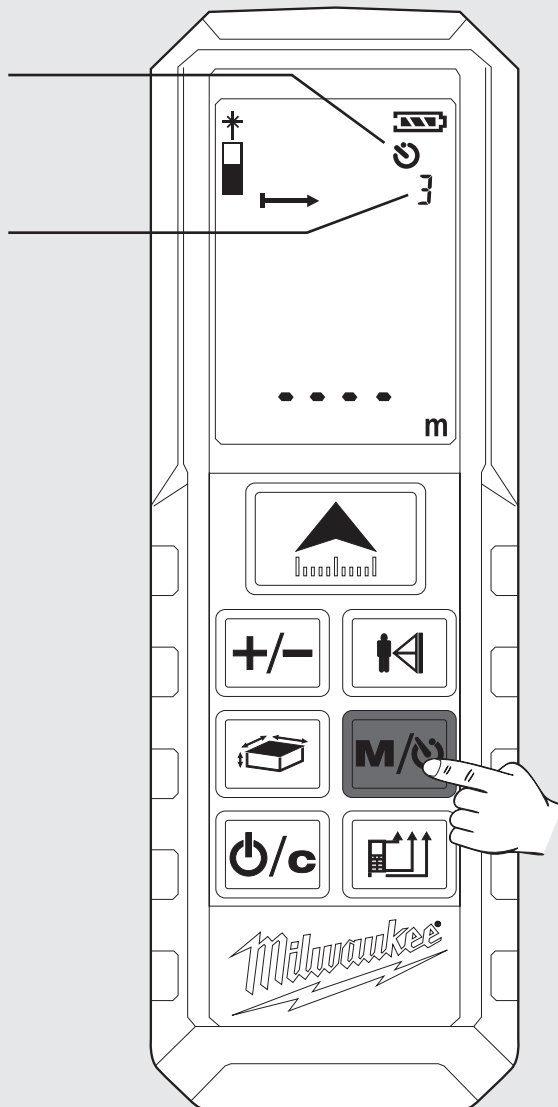

MEMÓRIA

Os valores de medição são memorizados automaticamente e sucessivamente na memória.

Os valores memorizados podem ser acessados com a tecla .

Pressione a tecla  por 2 seg

- O símbolo e o espaço de memória aparecem.
- Os parâmetros de medição correspondentes são indicados.
- O valor memorizado é mostrado na linha principal.
- Consultar os valores memorizados, pressionando a tecla  várias vezes.

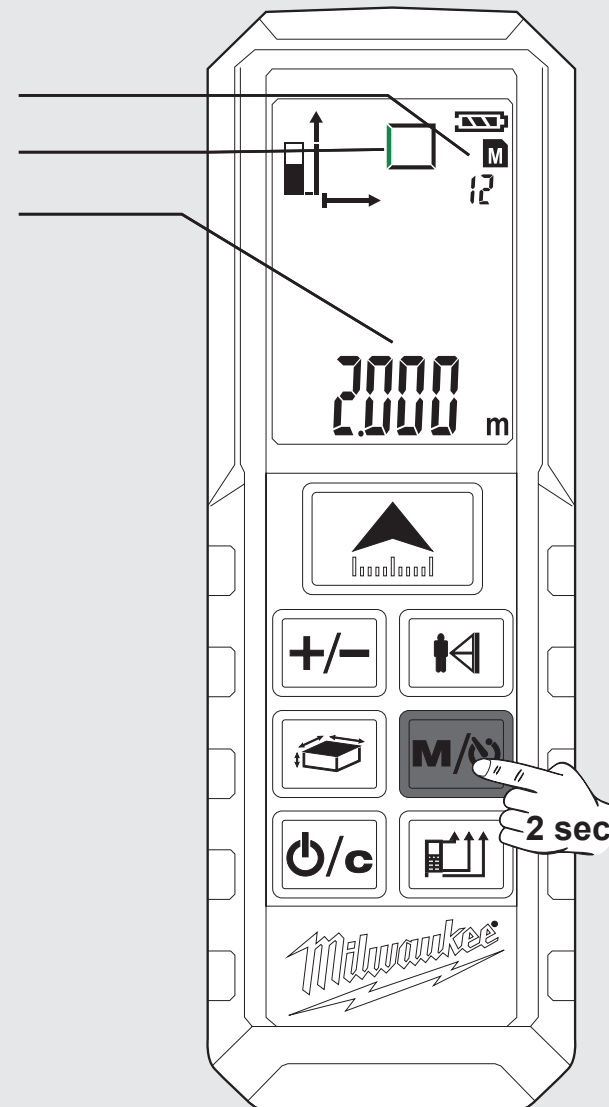

MODO DE FUNCIONAMENTO BÁSICO NO EXEMPLO DE UMA MEDIÇÃO DA ÁREA (1)

1 Ligar

Pressione a tecla .

⚠ Atenção! Raio laser ligado!
Não apontar contra pessoas!

2 Seleccione a referência de medição

Ajuste padrão depois de ligar: atrás

 Pressione 1x -> pino de canto
Pressione 2x -> frente
Pressione 3x -> atrás

3 Seleccione a função

Depois de ligar, o aparelho sempre está ajustado em medição do comprimento.

 Pressione 1x - Medição da área

4 Medir o comprimento

Alinhe o aparelho e pressione a tecla .

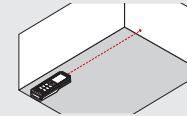

5 Medir a largura

Alinhe o aparelho e pressione a tecla .

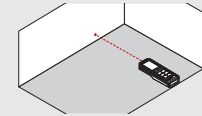

O símbolo do laser pisca (o piscar verde é mostrado).

O símbolo é mostrado

- O símbolo aparece
- O parâmetro de medição pisca (o piscar é mostrado em verde)

- O valor de medição aparece brevemente na linha principal.
- Após 1 seg o valor de medição salta para a linha superior.
- O valor de medição é memorizado na memória sob o número corrido.
- O segundo parâmetro de medição pisca. O aparelho está pronto para medir o segundo valor.

- O valor de medição aparece brevemente na linha principal.
- Após 1 seg o valor de medição salta para a linha superior.
- O valor de medição é memorizado na memória sob o número corrido.
- O resultado é mostrado na linha principal e é memorizado na memória sob o número corrido.

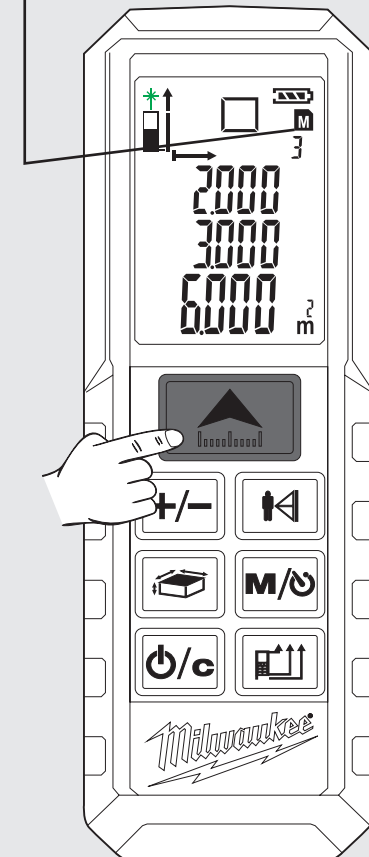
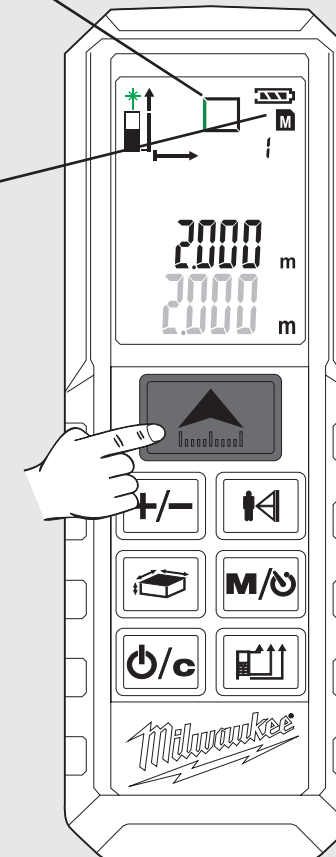
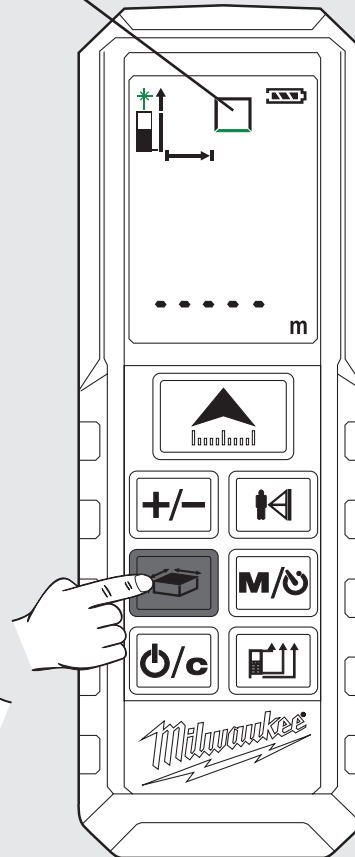
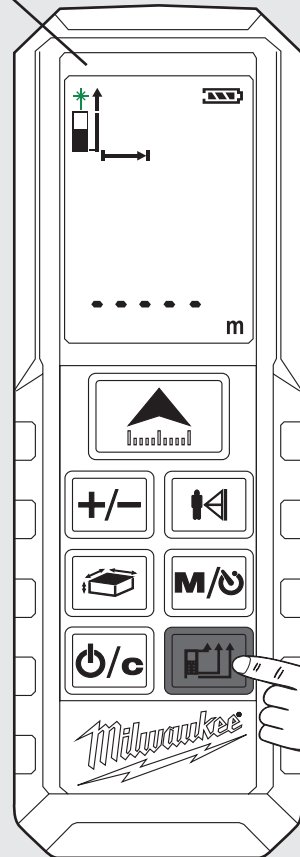
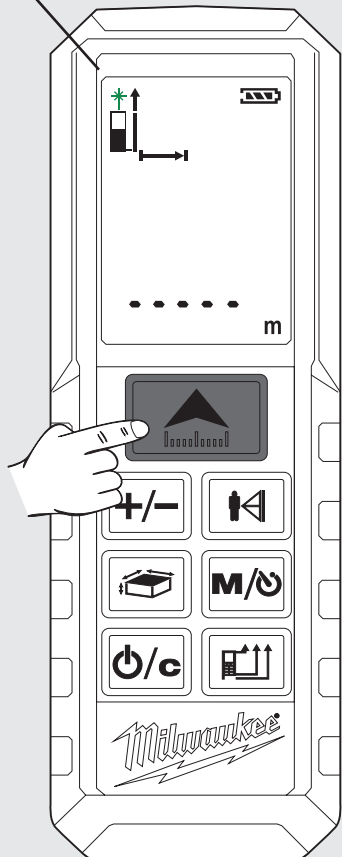

MODO DE FUNCIONAMENTO BÁSICO NO EXEMPLO DE UMA MEDIÇÃO DA ÁREA (2)

6 Ver os valores memorizados

Pressione a tecla **M/0** por 2 seg.
Pressionar a tecla **M/0** várias vezes.

7 Sair da memória

Pressione a tecla **0/c**

8 Desligar

Pressione a tecla **0/c** por 2 seg (primeiro, deverá ser saído da memória).

- Os valores memorizados são mostrados na linha principal.

- O símbolo correspondente é mostrado e o parâmetro de medição pisca (p piscar é mostrado em verde).

- O aparelho desliga-se.

- Se nenhuma tecla for pressionada por 3 minutos, o aparelho desligar-se-á automaticamente.

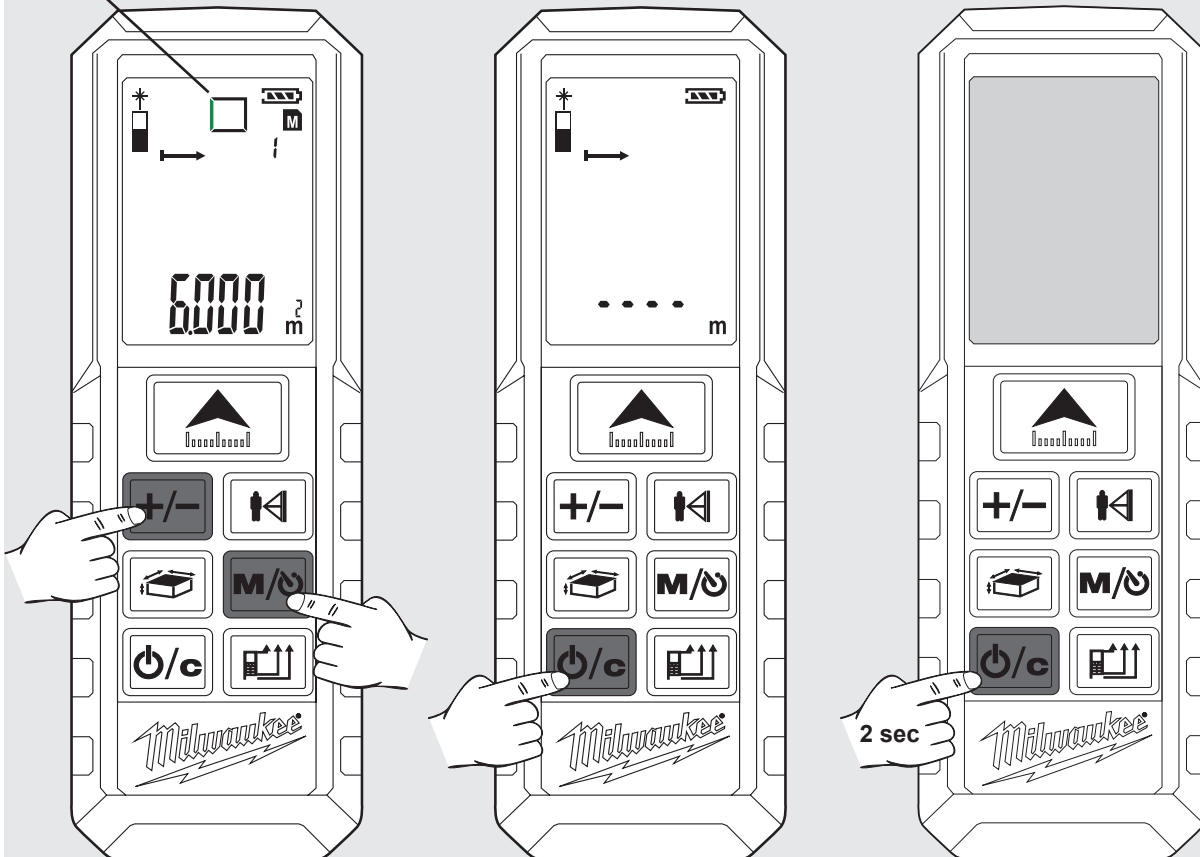

INHOUD

Belangrijke Veiligheidsvoorschriften	1
Technische gegevens	2
Voorgescreven gebruik van het systeem.....	2
Tabel met storingscodes	2
Overzicht	3
Vervangen van de batterijen.....	4
Hoekpen	4
Riemhouder	4
Functietoets, Pythagoras, meetniveau	5
Eenvoudige lengtemeting	6
Constance meting / minimum-/maximum-meting	7
Optel-/aftrekmeting	8
Oppervlaktemeting	9
Volumemeting	10
Indirecte meting (Pythagoras 1)	11
Indirecte meting (Pythagoras 2)	12
Indirecte meting (Pythagoras 3)	13
Wandoppervlaktemeting (scenario 1).....	14
Wandoppervlaktemeting (scenario 2).....	15
Timer	16
Geheugen	16
Principiële werking aan de hand van een oppervlaktemeting (1)	17
Principiële werking aan de hand van een oppervlaktemeting (2)	18

BELANGRIJKE VEILIGHEIDSVORSCHRIFTEN



Gebruik dit product niet voordat u de veiligheidsinstructies en de gebruiksaanwijzing op de bijgevoegde CD hebt bestudeerd.

Laserclassificatie

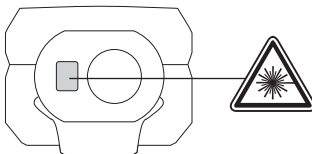

WAARSCHUWING:

Het is een Klasse 2 laserproduct in overeenstemming met EN60825-1:2014.



λ 650 nm P<1 mW

Waarschuwing!

Vermijd direct blikcontact. Het felle licht van de laserstraal kan tot letsel aan de ogen leiden en de ogen kortstondig verblinden.

Kijk niet in de laserstraal en richt niet onnodig op andere personen.

Andere personen niet verblinden.

Waarschuwing!

Het laserapparaat mag noch in de buurt van kinderen worden gebruikt noch mogen kinderen het apparaat gebruiken.

Opgelet! Een reflecterend oppervlak zou de laserstraal terug naar de bediener of een andere persoon kunnen reflecteren.

Houd een veilige afstand aan naar bewegende delen.

Verricht periodiek controlemetingen. Met name vlak voor, tijdens en na belangrijke metingen.

Pas op voor meetfouten als het instrument defect is of als het is gevallen, misbruikt of gemodificeerd.

Waarschuwing! Het gebruik van sturelementen of instellingen of de uitvoering van andere dan in de handleiding voorgescreven processen kan leiden tot een gevaarlijke stralingsbelasting.

Het lasermeettoestel heeft een beperkt toepassingsbereik. (Zie hoofdstuk 'Technische gegevens'). Pogingen om buiten het maximale en minimale bereik te meten resulteren in onnauwkeurige resultaten. De toepassing onder ongunstige omstandigheden, zoals te grote hitte of koude, fel zonlicht, regen, sneeuw, mist of andere, het zicht belemmerende omstandigheden kan leiden tot onnauwkeurige meetresultaten.

Als het lasermeettoestel van een warme naar een koude omgeving wordt gebracht (of omgekeerd), moet u even wachten totdat het toestel zich aan de nieuwe omgevingstemperatuur heeft kunnen aanpassen.

Bewaar het lasermeettoestel altijd in gesloten ruimten en bescherm het tegen schokken, vibraties of extreme temperaturen.

Bescherm het lasermeettoestel tegen stof, natheid en te hoge luchtvochtigheid. Deze factoren zouden inwendige onderdelen onherstelbaar kunnen beschadigen of de nauwkeurigheid negatief kunnen beïnvloeden.

Gebruik geen agressieve reinigingsmiddelen of oplosmiddelen. Reinig het toestel uitsluitend met een schone, zachte doek.

Voorkom harde stoten en laat het toestel niet vallen. De nauwkeurigheid van het toestel dient te worden gecontroleerd als het gevallen is of aan andere mechanische belastingen werd blootgesteld.

Vereiste reparaties aan dit laserapparaat mogen alleen worden uitgevoerd door geautoriseerd vakpersoneel.

Gebruik het instrument niet in ruimten met explosiegevaar of in een agressieve omgeving.

Gebruik uitsluitend acculaders aanbevolen door de fabrikant van de batterijen.

 Afgedankte batterijen en afgedankte elektrische en elektronische apparatuur mogen niet samen via het huisafval worden afgevoerd. Afgedankte batterijen en afgedankte elektrische en elektronische apparatuur moeten gescheiden ingezameld en afgevoerd worden.

Verwijder afgedankte batterijen, afgedankte accu's en verlichtingsmiddelen uit de apparatuur voordat u deze afvoert.

Informeer bij uw gemeente of bij uw vakhandelaar naar recyclingbedrijven en inzamelpunten.

Al naargelang de lokaal van toepassing zijnde voorschriften kunnen detailhandelaren verplicht zijn om afgedankte batterijen, afgedankte elektrische en elektronische apparatuur kosteloos terug te nemen.

Geef uw afgedankte batterijen, afgedankte elektrische en elektronische apparatuur af voor recycling en help zo mee om de behoefte aan grondstoffen te verminderen.

Afgedankte batterijen (vooral lithium-ion-batterijen), afgedankte elektrische en elektronische apparatuur bevatten waardevolle, recyclebare materialen die, mits ze niet milieuvriendelijk worden afgevoerd, negatieve gevolgen kunnen hebben voor het milieu en uw gezondheid.

Verwijder persoonlijke gegevens van uw afgedankte apparatuur voordat u deze afvoert.

 Europees symbool van overeenstemming

 Britse conformiteitsmarkering

 Oekraïens symbool van overeenstemming

 Euro-Aziatisch symbool van overeenstemming

TECHNISCHE GEGEVENS

Veiligheidsklasse	IP54 (tegen stof en spatwater beschermd)
Optiek	14 mm
Brandpunt	35 mm
Meetbereik max.	50 meter (tolerantie: 55m)
Meetbereik min.	0,05 meter
Absolute nauwkeurigheid @ < 10m	± 1,5 mm (max.)
Herhalingsnauwkeurigheid @ < 10m	± 1,5 mm (karakteristiek max. 2σ)
Herhalingsnauwkeurigheid @ > 10m	stijging ± 0,25 mm / meter (karakteristiek max. 2σ)
Meettijd	0,5 s
Displaytype	lcd (22,7 mm x 31 mm)
Stroomvoorziening	AAA 2x (alkaline-batterij)
Batterijlevensduur	10.000 (afzonderlijke metingen)
Uitgangsvermogen van de laser	0,6 mW ~ 0,95 mW (class 2, 650nm)
Grootte van de laserpunt	25 x 30 mm @ 16 m (max.)
Laserklasse	2
Lasertype	650 nm, < 1 mW
Laserstraal verticale hoek	+1 graad
Laserstraal horizontale hoek	±1 graad
Automatische uitschakeling toestel	180 seconden
Automatische uitschakeling laser	30 seconden
Arbeidstemperatuurbereik	-10°C tot +50°C
Opslagtemperatuurbereik	-25°C tot +70°C
Gewicht zonder batterij	80 g

VOORGESCHREVEN GEBRUIK VAN HET SYSTEEM

Het lasermeettoestel is geschikt voor het meten van afstanden en neigingen.
Dit apparaat uitsluitend gebruiken voor normaal gebruik, zoals aangegeven.

TABEL MET STORINGSCODES

Code	Beschrijving	Maatregel
Err01	Buiten het meetbereik	Meting uitvoeren in voorgeschreven bereik.
Err02	Reflecterend signaal is te zwak	Een beter oppervlak kiezen.
Err03	Buiten het weergavebereik (max. waarde: 99.999) bijv. het resultaat van een oppervlak of volume buiten het weergavebereik	Controleer of de waarden en stappen correct zijn.
Err04	Fout in de Pythagorasberekening	Controleer of de waarden en stappen correct zijn.
Err05	Batterij zwak	Nieuwe batterij plaatsen.
Err06	Buiten het arbeidstemperatuurbereik	Meting uitvoeren in het voorgeschreven arbeidstemperatuurbereik.
Err07	Omgevingslicht te fel	Doelbereik donkerder maken.

Pythagoras
Hoogteverschil

Meetniveau

Lengtemeting

Minimum / maximum voor constante meting

Optellen / aftrekken

AAN / METEN

- ▶ Aan
- ▶ Meten
- ▶ Constante meting (2 sec. indrukken)
Min./max.-functie

OPTELLEN / AFTREKKEN

- ▶ Waarde optellen
- ▶ Navigeren in het geheugen

OPPERVLAK / VOLUME

- ▶ Oppervlak (1x indrukken)
- ▶ Volume (2x indrukken)
- ▶ Indirecte oppervlaktemeting (3x / 4x indrukken)

INSCHAKELEN

- ▶ Aan
- ▶ Uit (2 sec. indrukken)
- ▶ Terugzetten

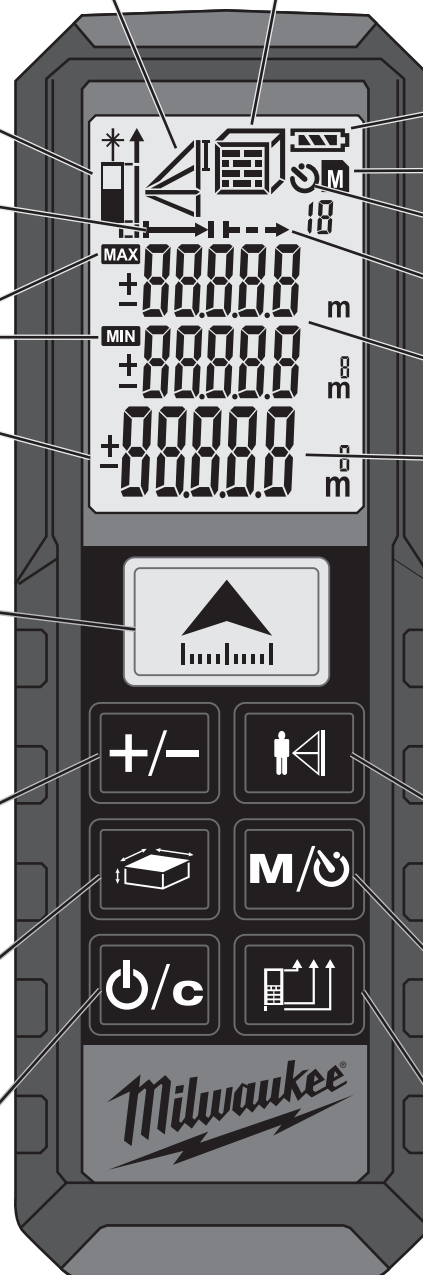

Oppervlak / volume
Indirecte oppervlaktemeting

Batterijstatus

Geheugen

Timer

Constante meting

Tussenwaarden

Totale waarde

PYTHAGORAS

- ▶ Pythagoras 1 (1x indrukken)
- ▶ Pythagoras 2 (2x indrukken)
- ▶ Pythagoras 3 (3x indrukken)

GEHEUGEN

- ▶ Timer 3-15 sec. (1x indrukken)
- ▶ Geheugen 1-20 (1x 2 sec. indrukken)
- ▶ Opgeslagen waarden oproepen (herhaaldelijk indrukken)

MEETNIVEAU OMSCHAKELEN

- ▶ Voor
- ▶ Achter
- ▶ Hoekpen

VERVANGEN VAN DE BATTERIJEN

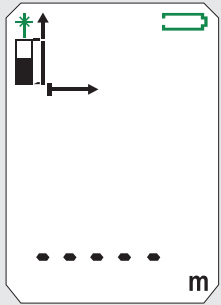

Vervang de batterij als het symbool begint te knippen.

1

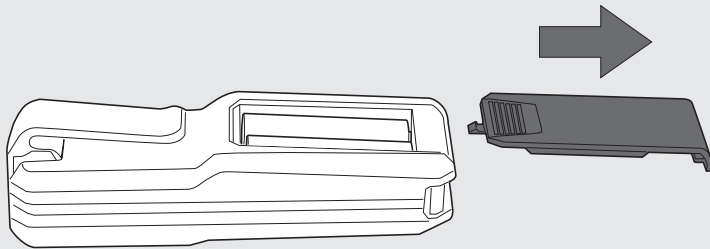

2

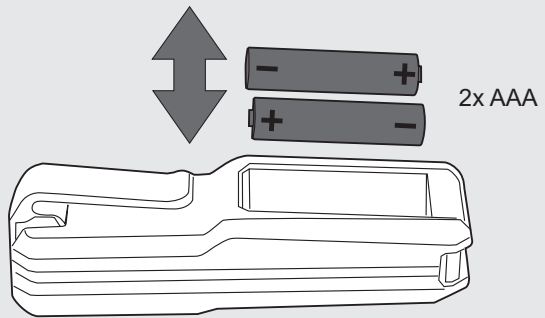

3

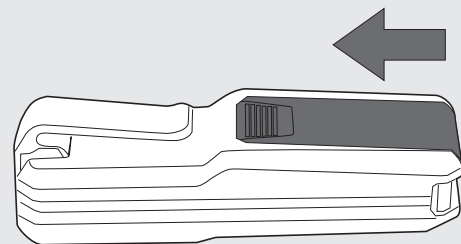

HOEKPEN

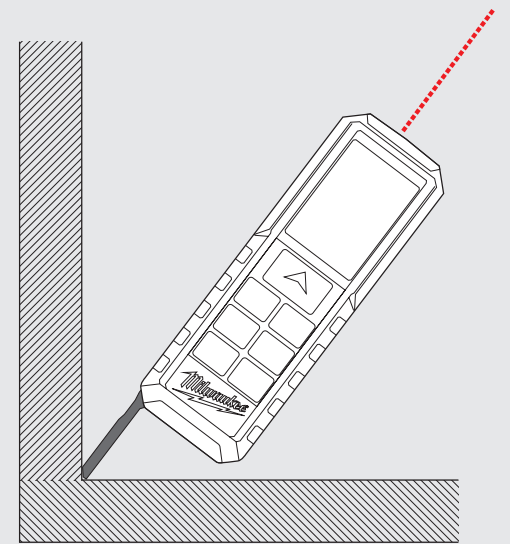
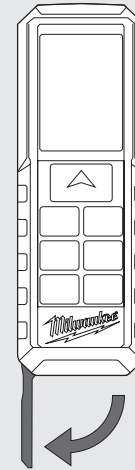

RIEMHOUDER

1

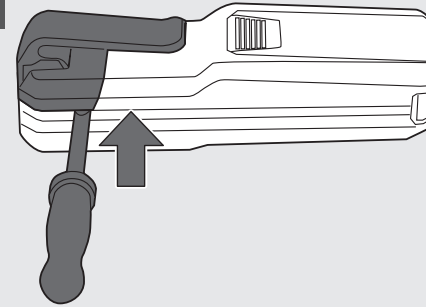

2

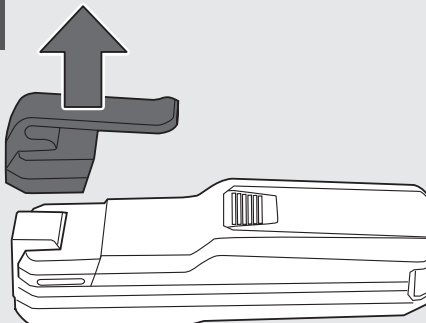



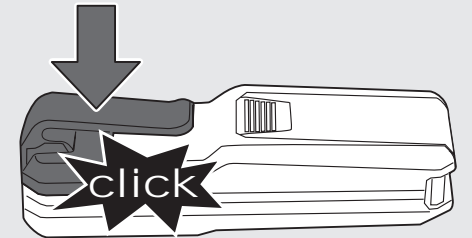

3

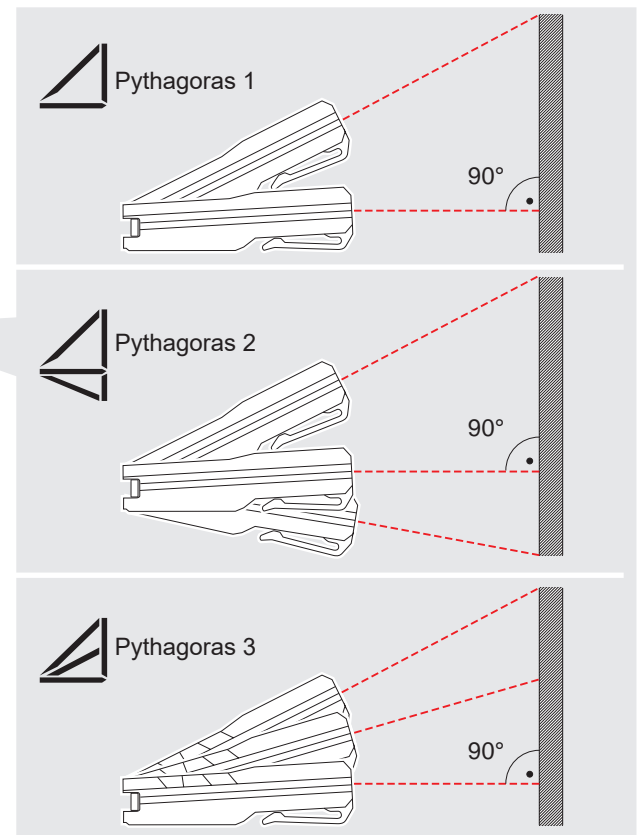
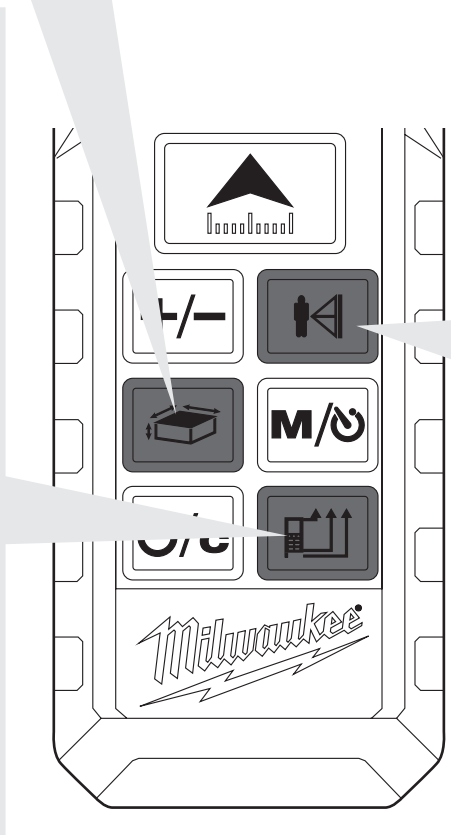
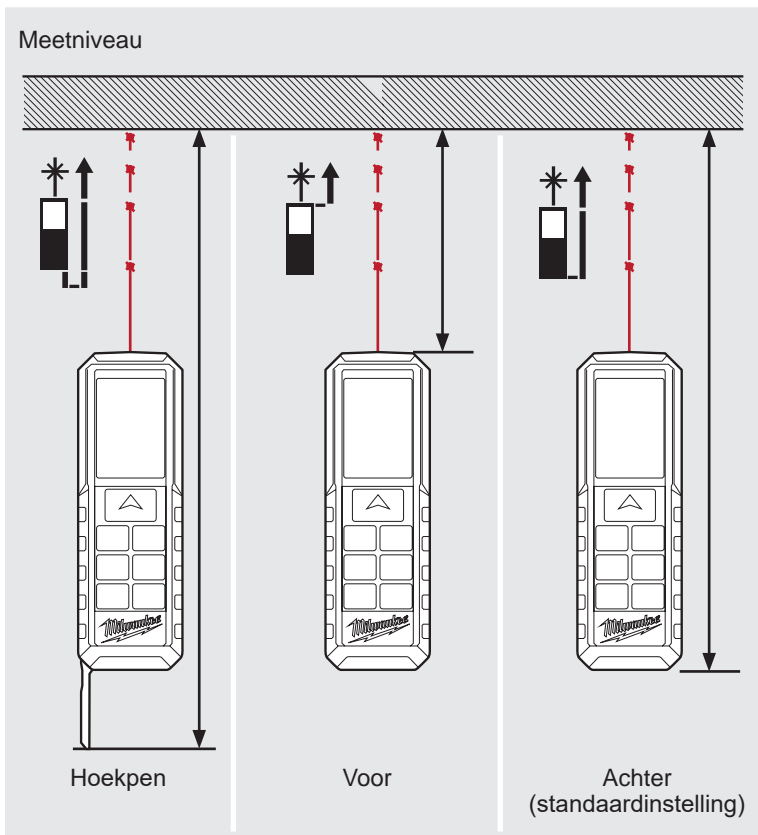
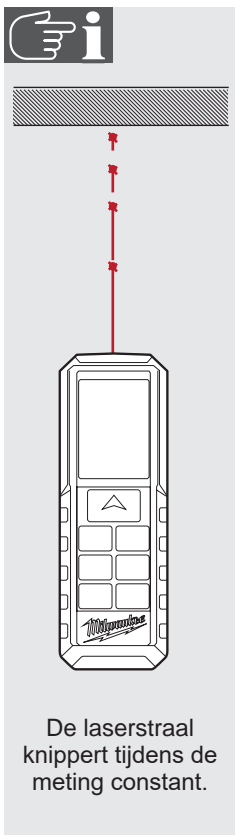
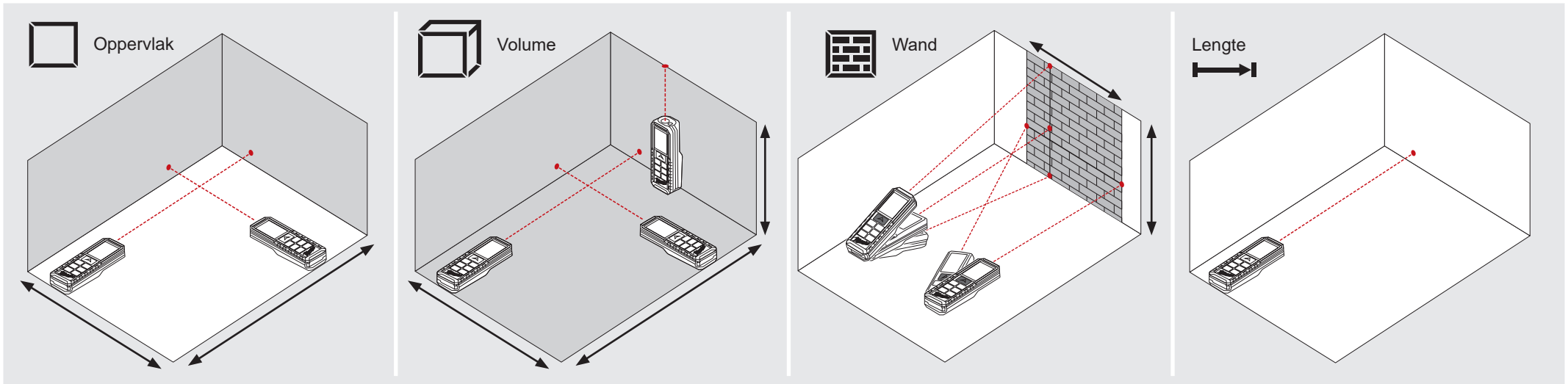



FUNCTIETOETS, PYTHAGORAS, MEETNIVEAU

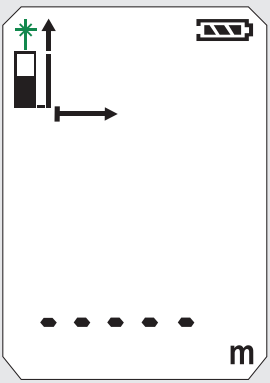
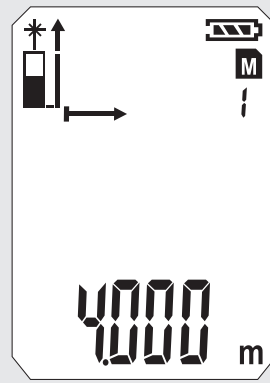
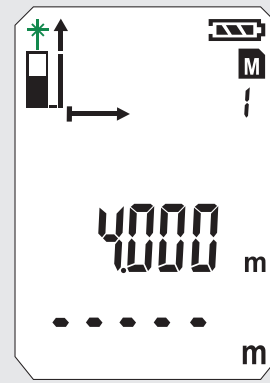
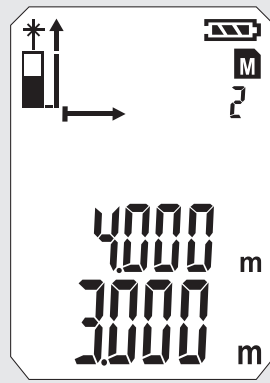
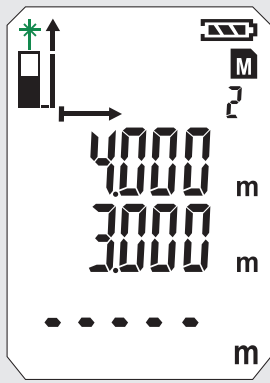

EENVOUDIGE LENGTEMETING

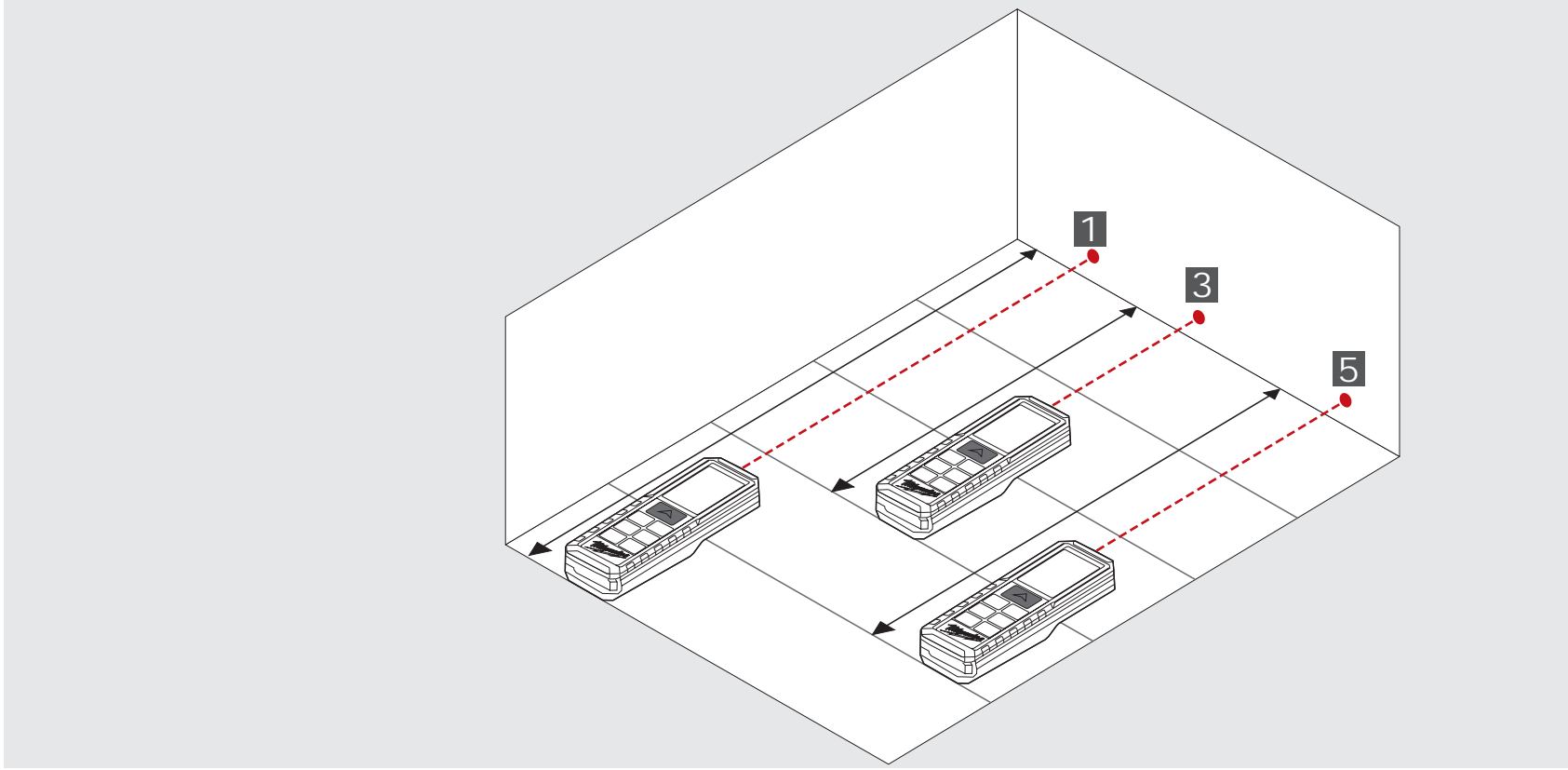
0	1 	2 	3 	4 
				

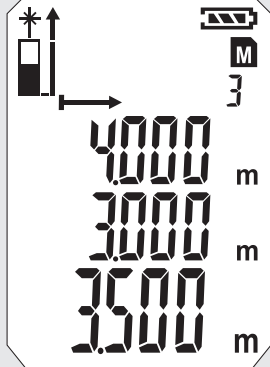

5 

CONSTANTE METING / MINIMUM-/MAXIMUM-METING

0

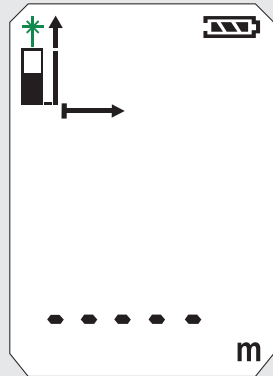

1

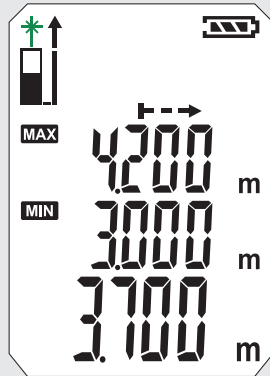

2

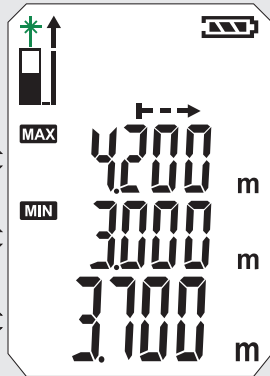
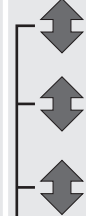

3

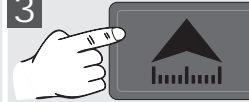

Stop
MIN / MAX



4

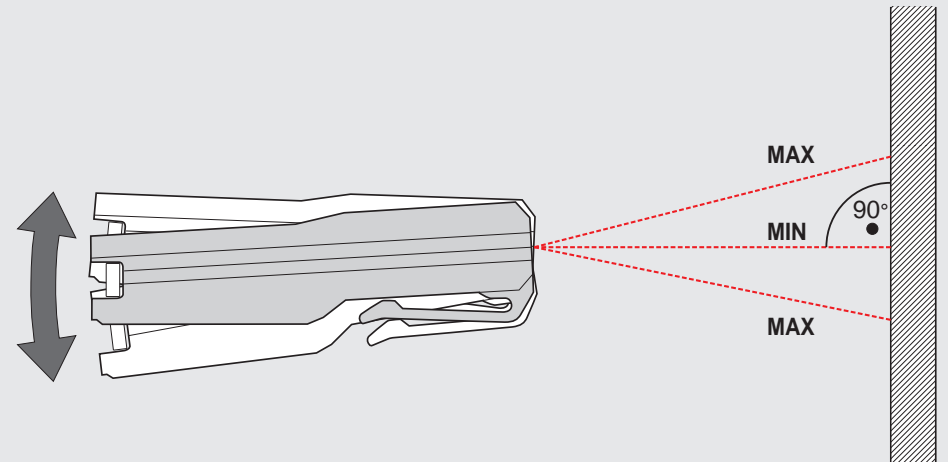
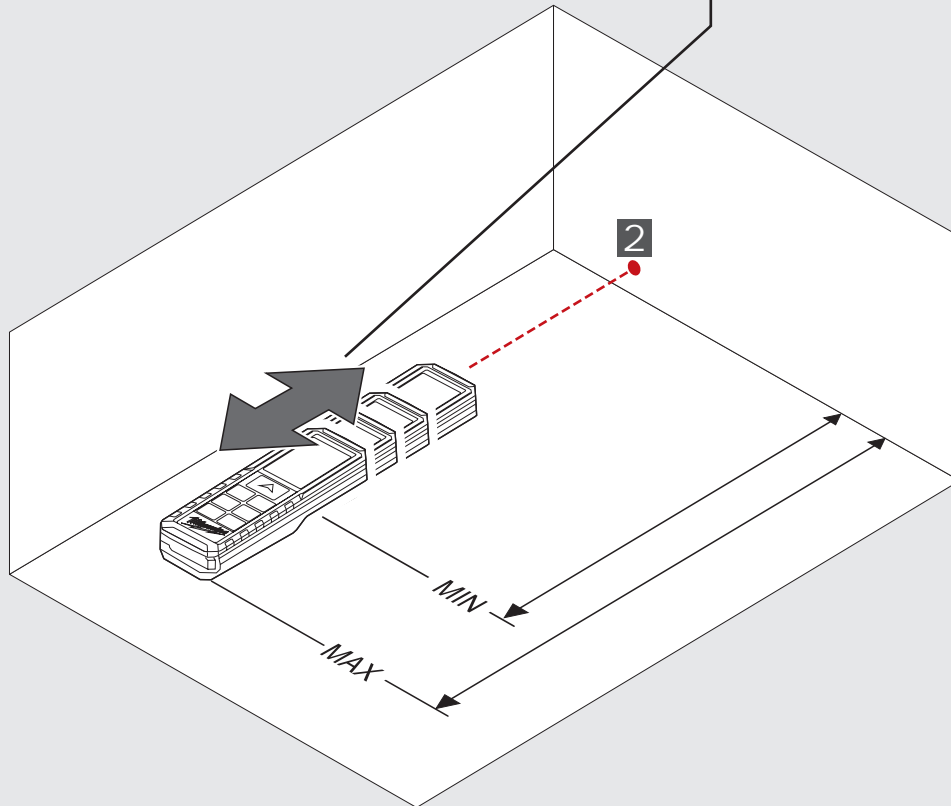
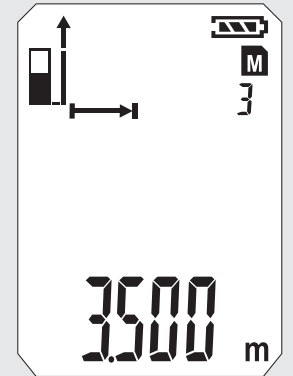

0

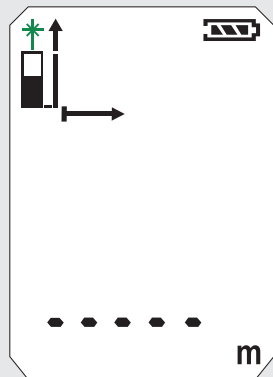

1

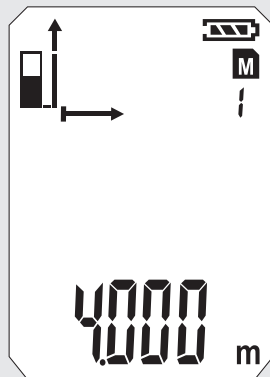

2

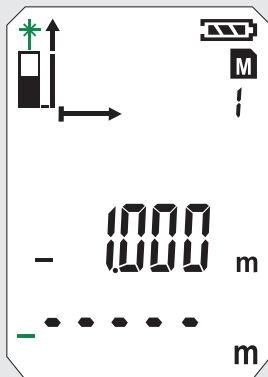

3

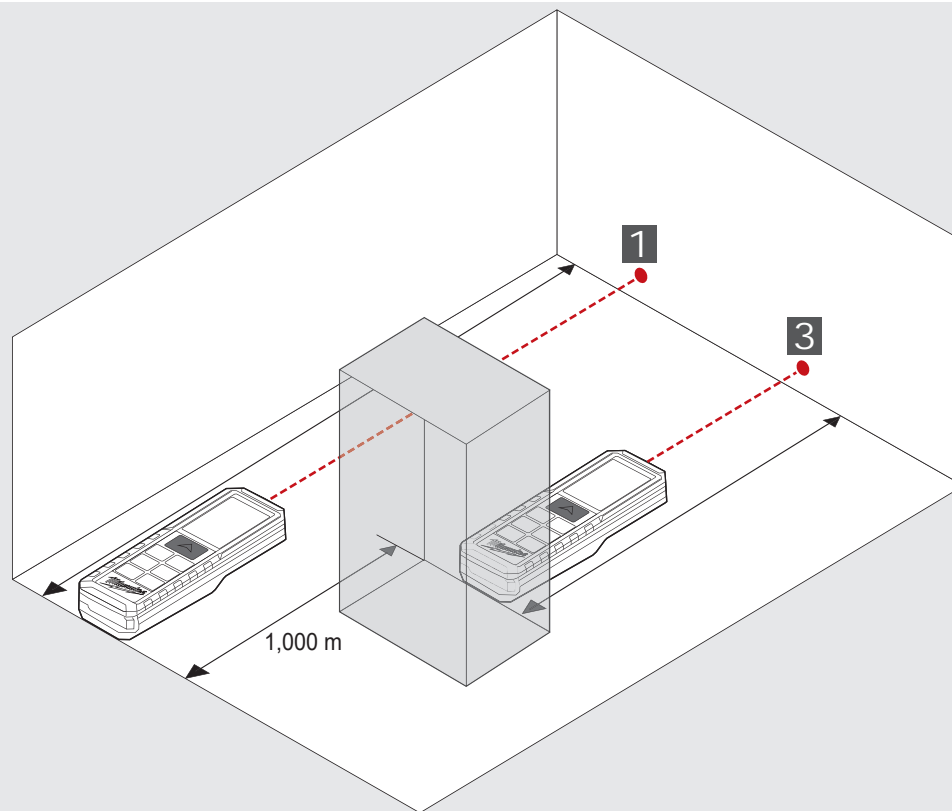
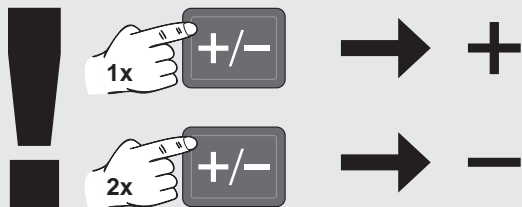
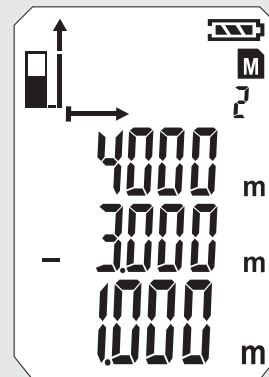

OPPERVLAKMETING

0



1



2

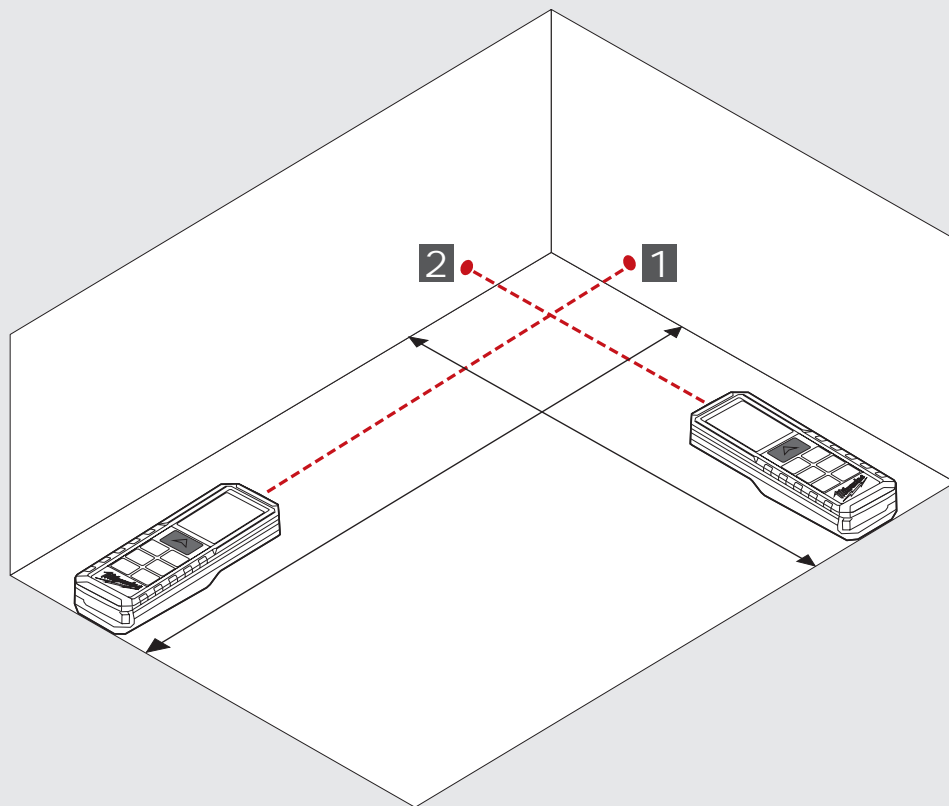
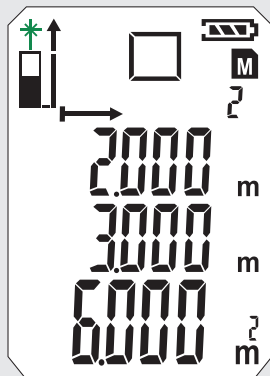
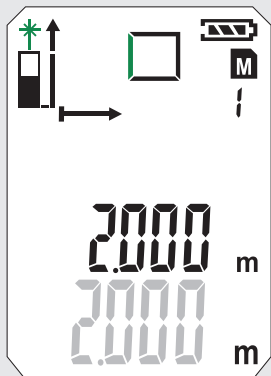
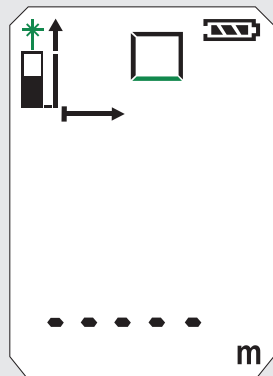

VOLUMEMETING

0



1



2



3

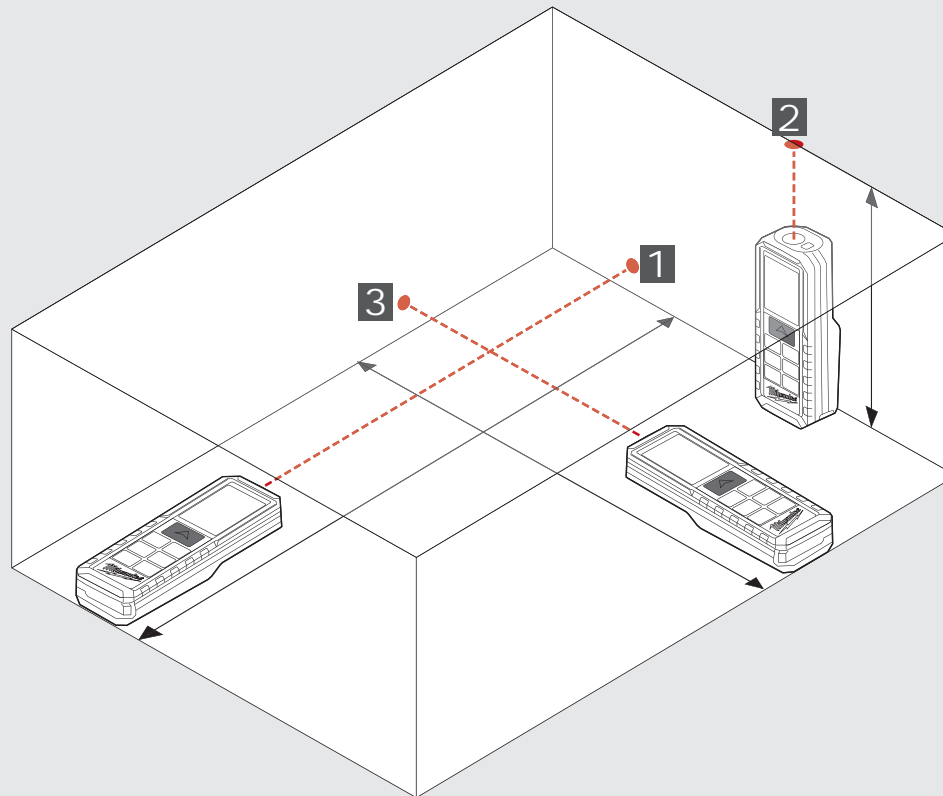
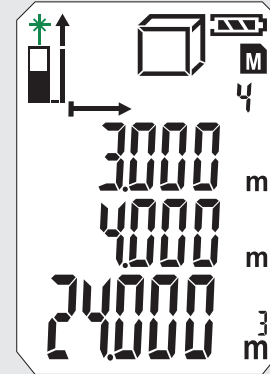
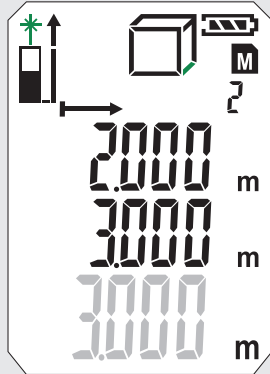
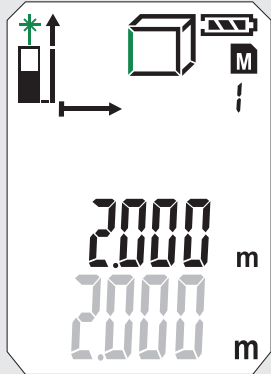
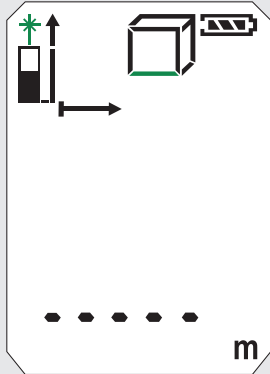

INDIRECTE METING (PYTHAGORAS 1)

0



1



2

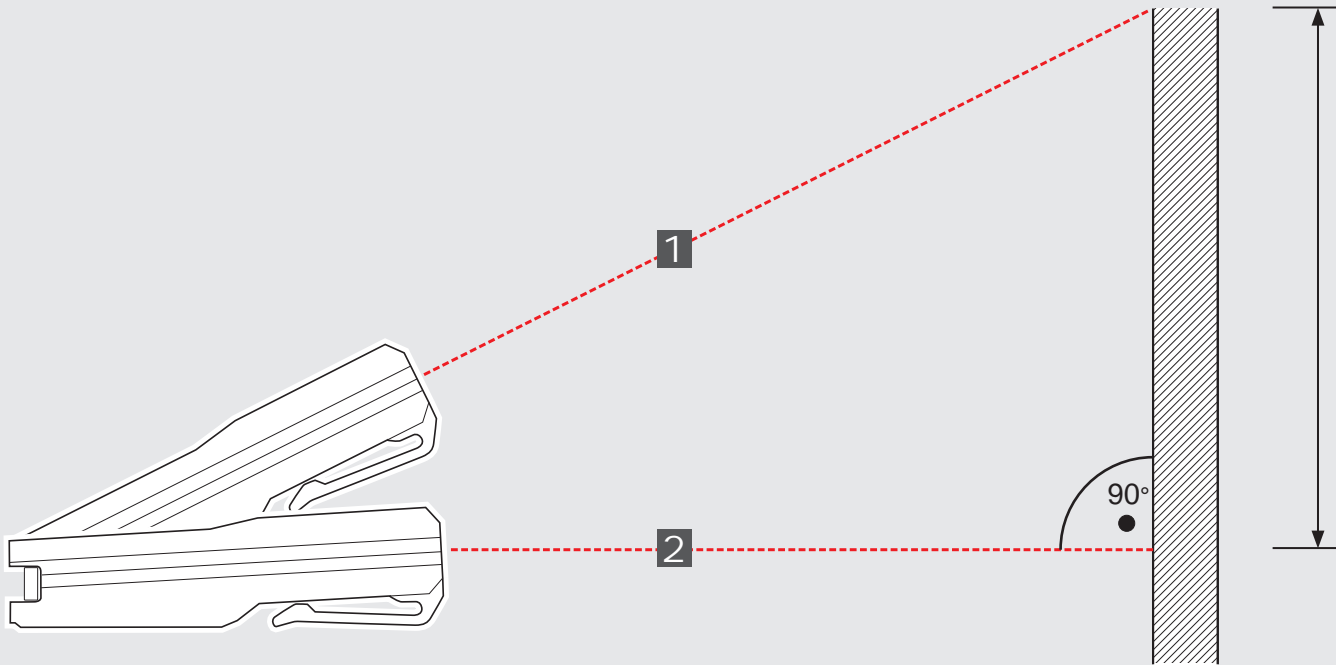
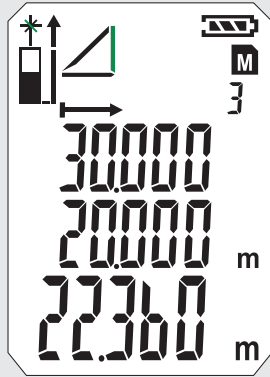
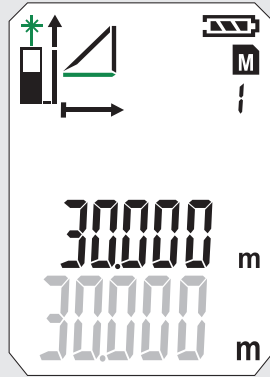
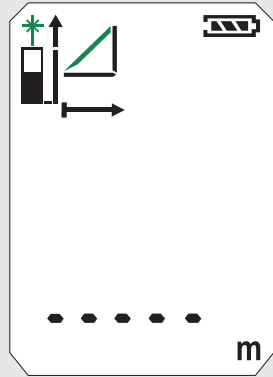

INDIRECTE METING (PYTHAGORAS 2)

0

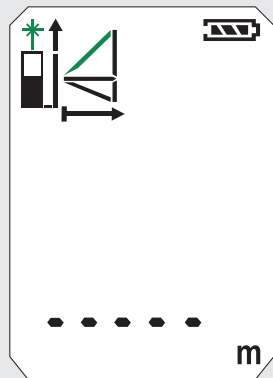

1

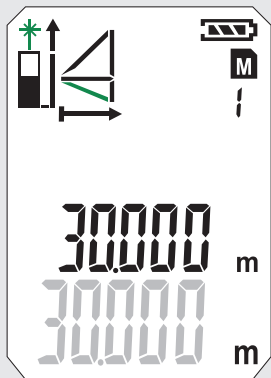



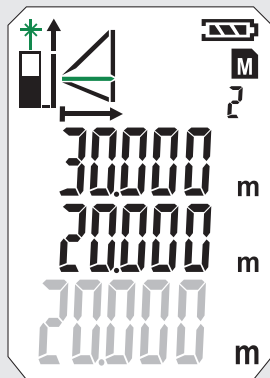

2

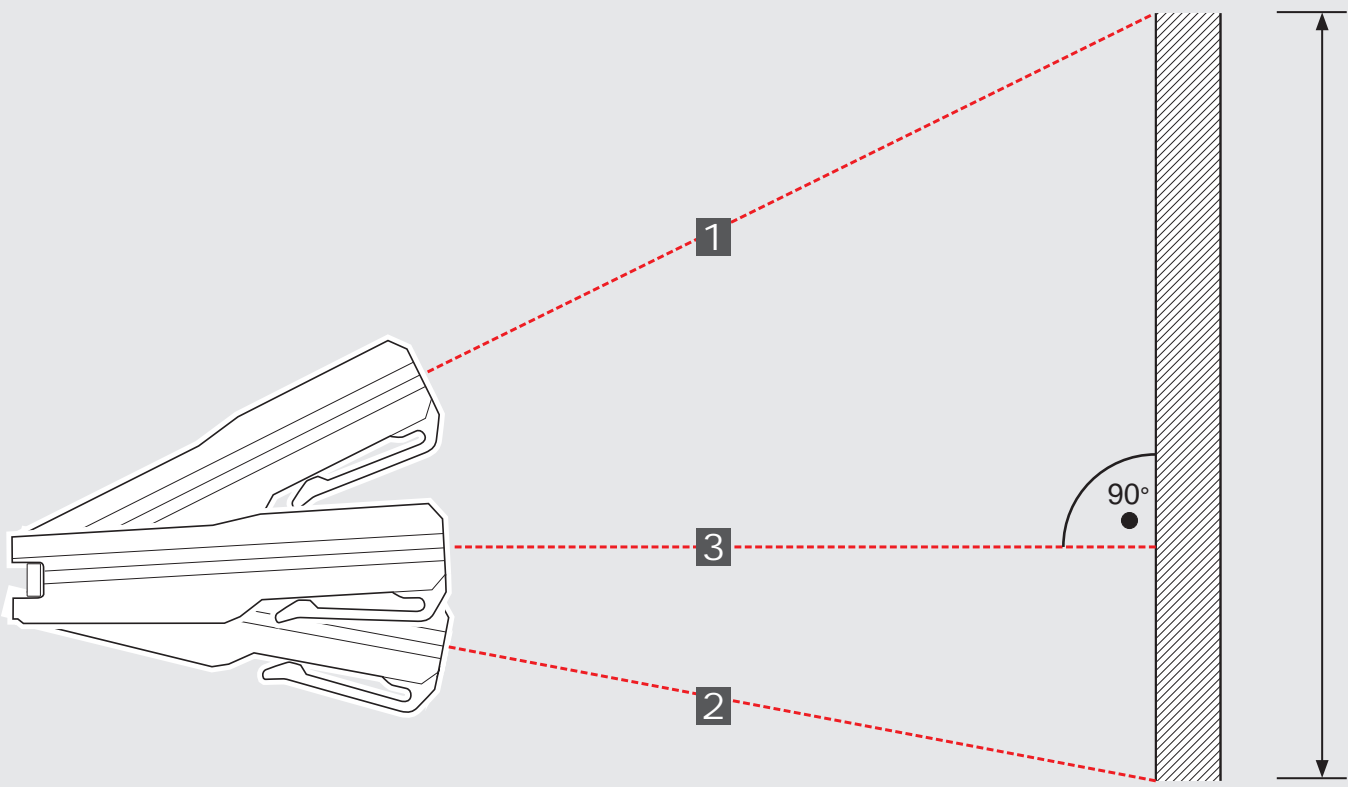
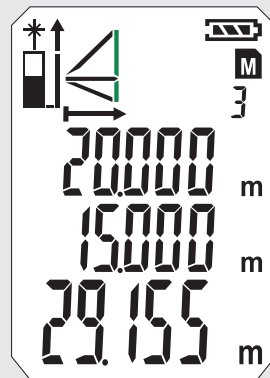

3





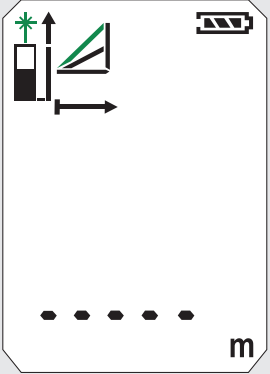
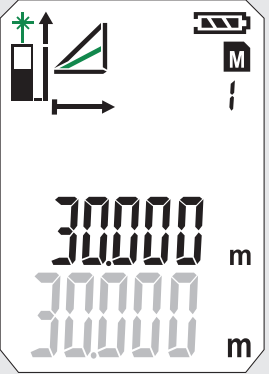
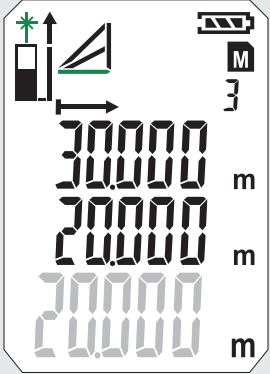
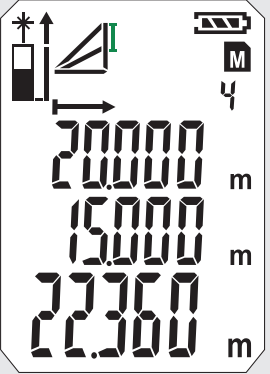

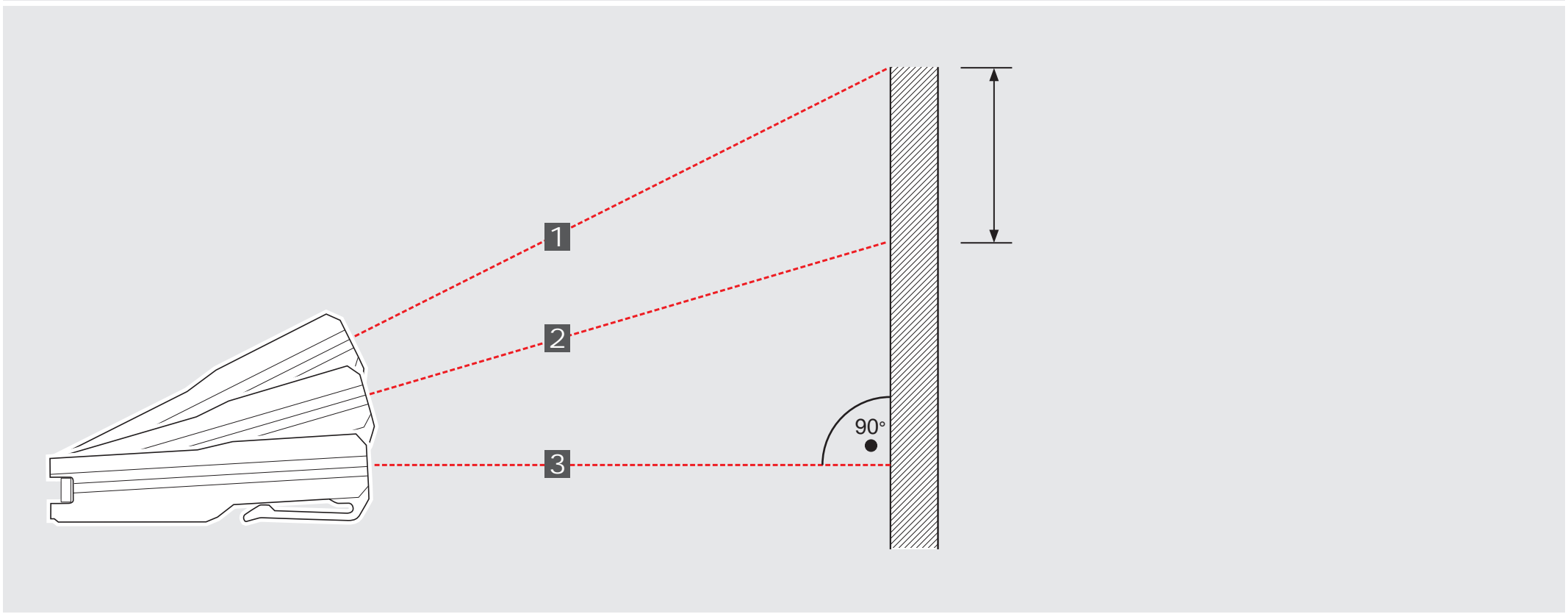

INDIRECTE METING (PYTHAGORAS 3)

<p>1</p> 	<p>2</p> 	<p>3</p> 	<p>4</p> 
			



WANDOPPERVLAKMETEMETING (SCENARIO 1)

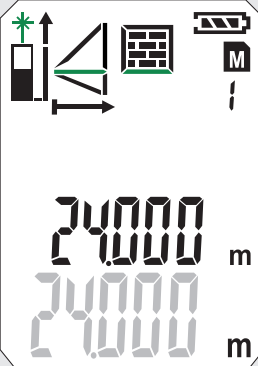
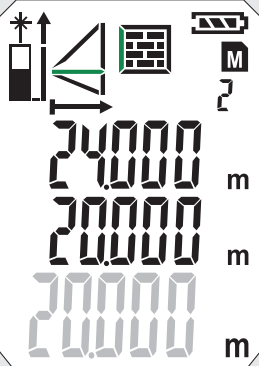
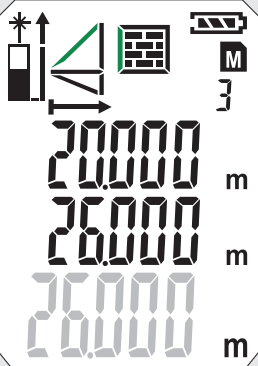
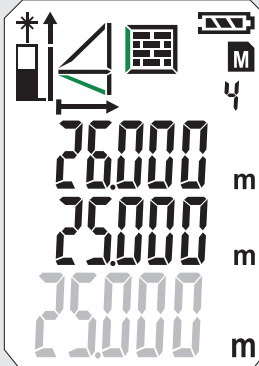

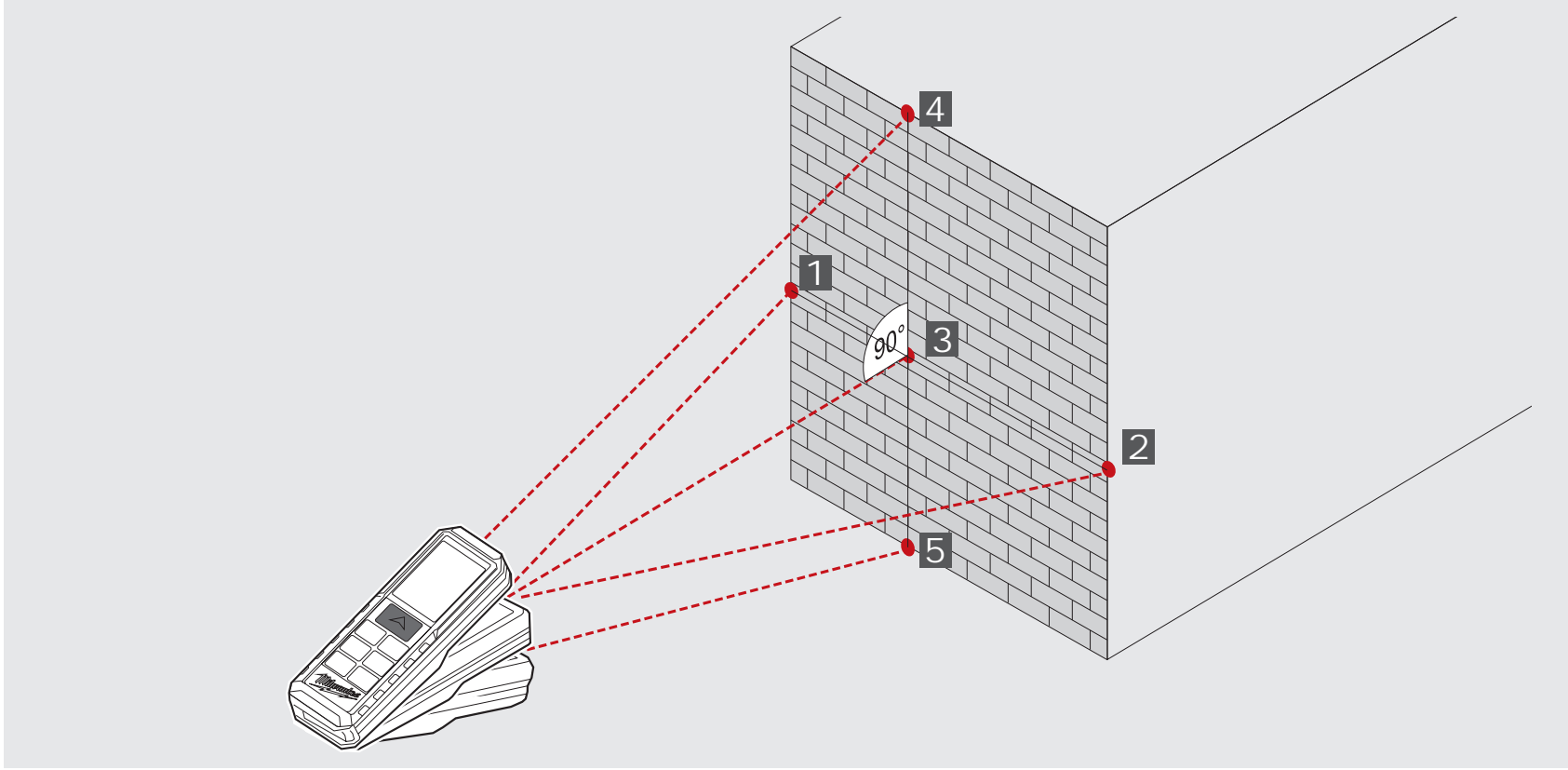

<p>0</p> 	<p>1</p> 	<p>2</p> 	<p>3</p> 	<p>4</p> 
				

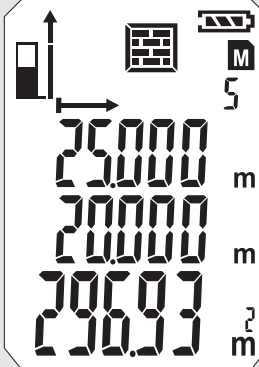

5



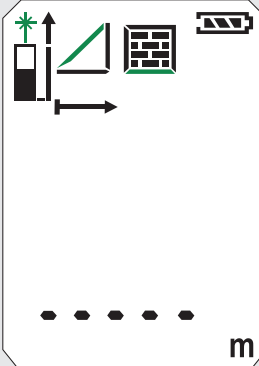
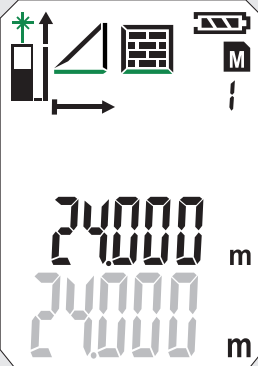
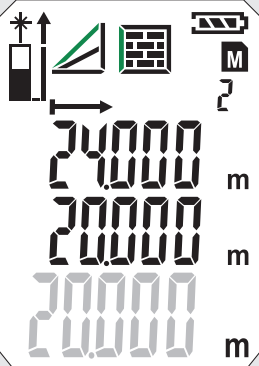
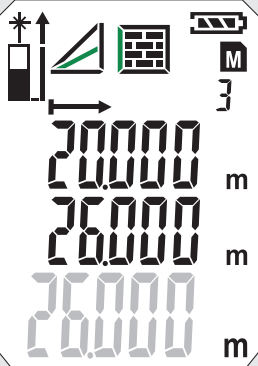
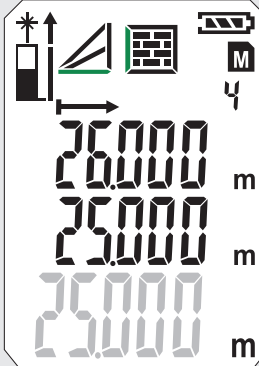

WANDOPPERVLAKMETING (SCENARIO 2)

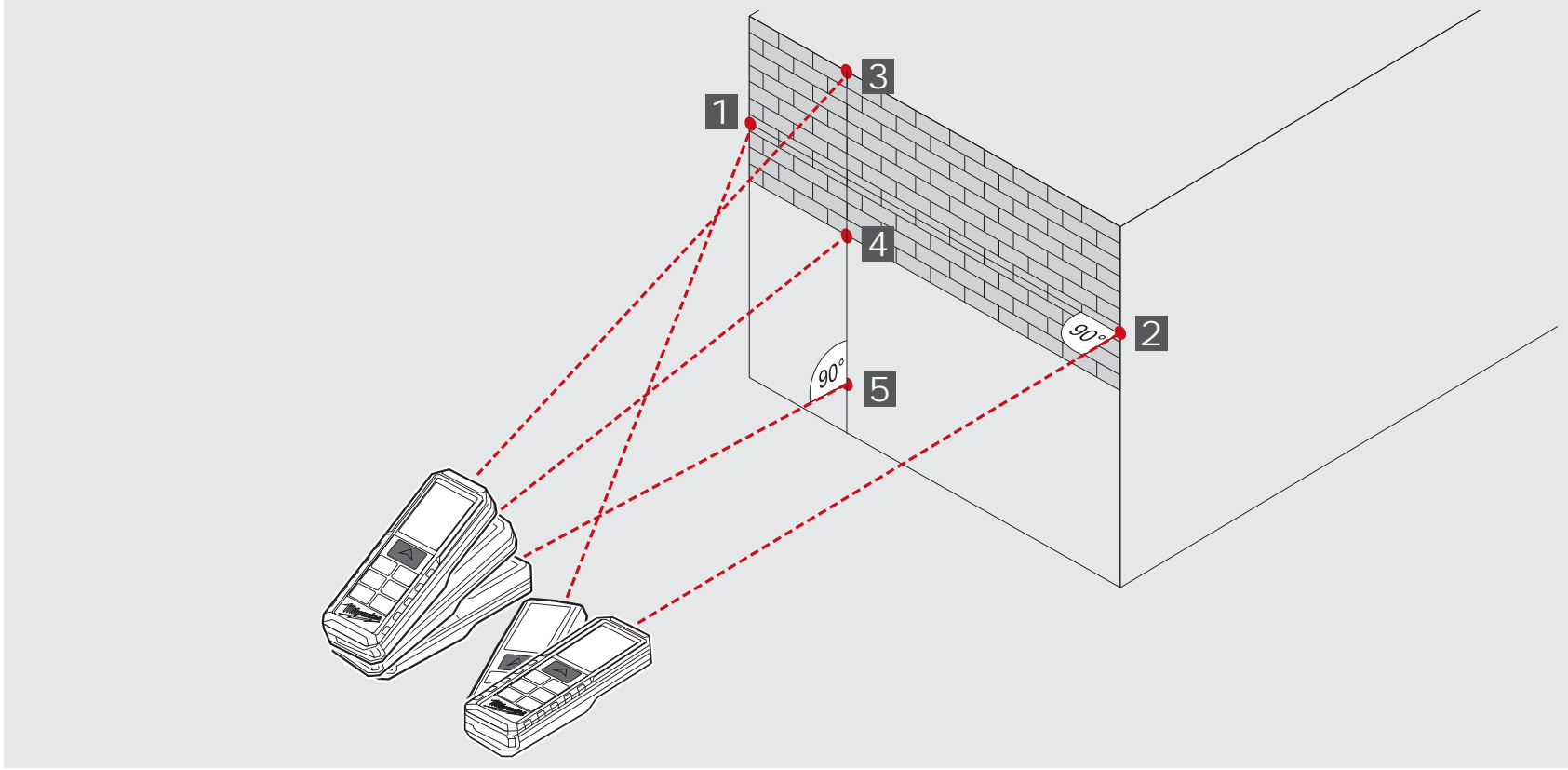
<p>0</p> 	<p>1</p> 	<p>2</p> 	<p>3</p> 	<p>4</p> 
				



5



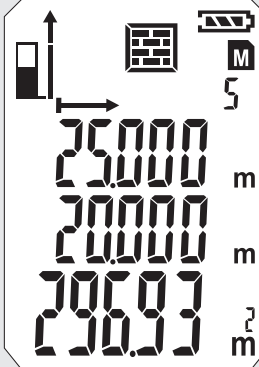

TIMER

Met de timer kan de meting vertraagd worden geactiveerd om bijv. een onderdeel in de meetstraal te kunnen plaatsen.

Toets  indrukken

- Symbool verschijnt
- Door het indrukken van de toets  kan de timer tussen 3 en 15 sec. worden ingesteld.

Toets  indrukken

- De seconden tot de meting worden teruggeteld.
- Bij 0 wordt de meting geactiveerd.

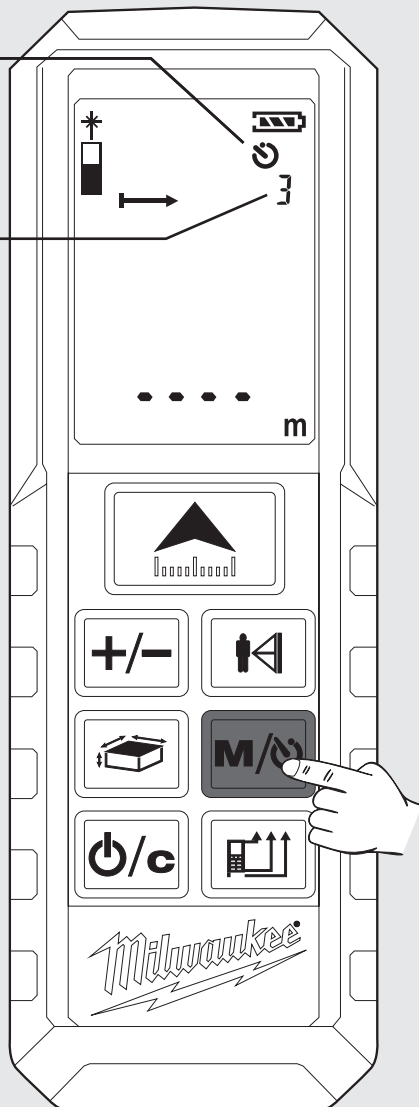

GEHEUGEN

De meetwaarden worden automatisch doorlopend in het geheugen opgeslagen.

De opgeslagen waarden kunnen worden opgeroepen met behulp van de toets .

Toets  2 sec. lang indrukken

- Het symbool en de geheugenplaats verschijnen.
- De bijbehorende meeteenheid wordt weergegeven.
- De opgeslagen waarde wordt in de hoofdregel weergegeven.
- Opgeslagen waarden oproepen door de toets  herhaaldelijk in te drukken.

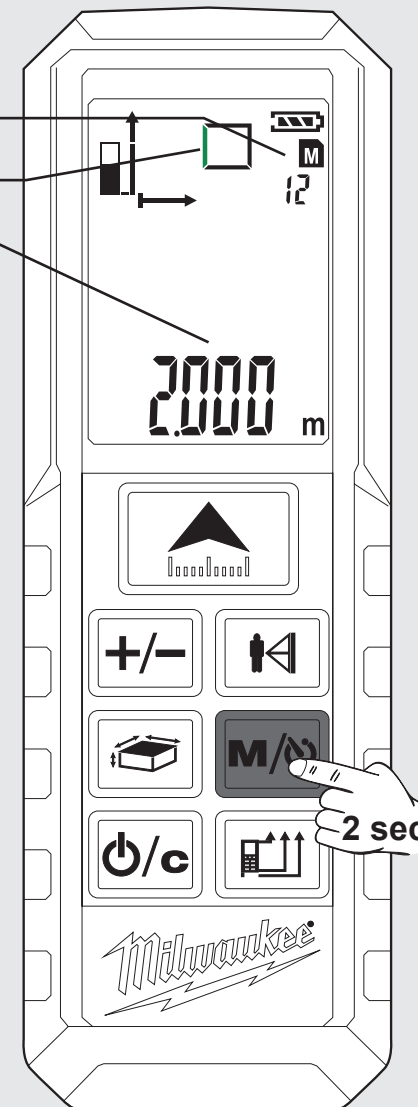

PRINCIPIËLE WERKING AAN DE HAND VAN EEN OPPERVLAKMETING (1)

1 Inschakelen

Toets  indrukken.
⚠ Opgelet! Laserstraal inschakelen!
 Niet op personen richten!

Het lasersymbool knippert (knipperen wordt groen weergegeven).

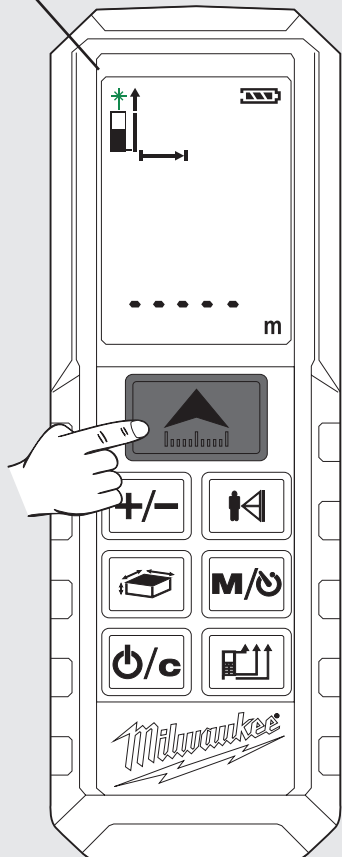

2 Meetniveau selecteren

Standaardinstelling na het inschakelen: achter
 1x indrukken -> hoekpen
 2x indrukken -> voor
 3x indrukken -> achter

Symbol wordt weergegeven

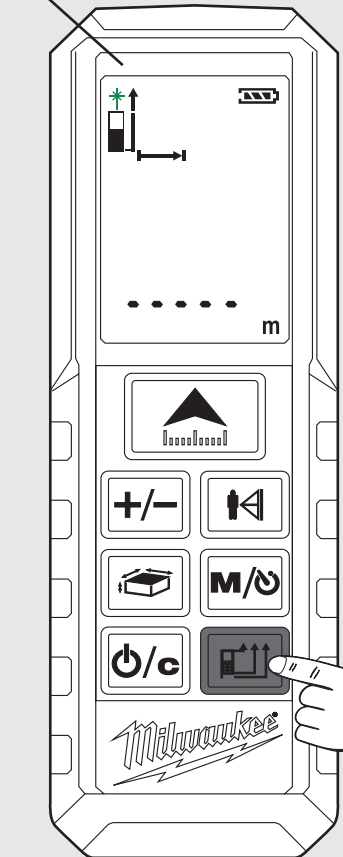

3 Functie kiezen

Na het inschakelen staat het apparaat altijd ingesteld op lengtemeting.
 1x indrukken - oppervlakmeting

- Het symbool verschijnt
 - De meeteenheid knippert (knipperen wordt groen weergegeven).

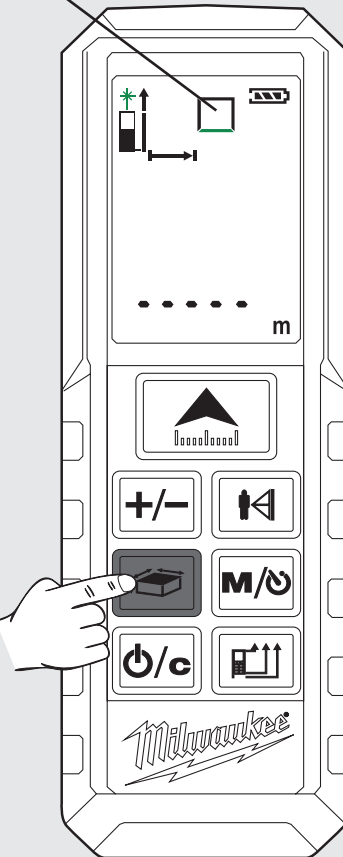

4 Lengte meten

Het toestel uitlijnen en toets  indrukken

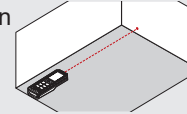

- De meetwaarde verschijnt kort in de hoofdregel.
 - De meetwaarde springt na 1 sec. naar de daarboven liggende regel.
 Meetwaarde wordt in het geheugen opgeslagen onder een volgnummer.
 Tweede meeteenheid knippert. Het toestel is gereed voor de meting van de tweede waarde.

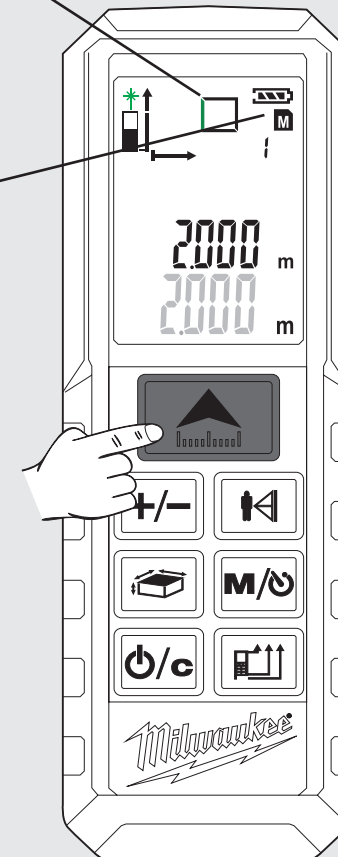

5 Breedte meten

Het toestel uitlijnen en toets  indrukken

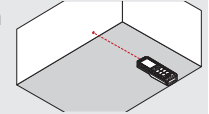

- De meetwaarde verschijnt kort in de hoofdregel.
 - De meetwaarde springt na 1 sec. naar de daarboven liggende regel.
 Meetwaarde wordt in het geheugen opgeslagen onder een volgnummer.
 - Het resultaat verschijnt in de hoofdregel en wordt in het geheugen opgeslagen onder het volgnummer.

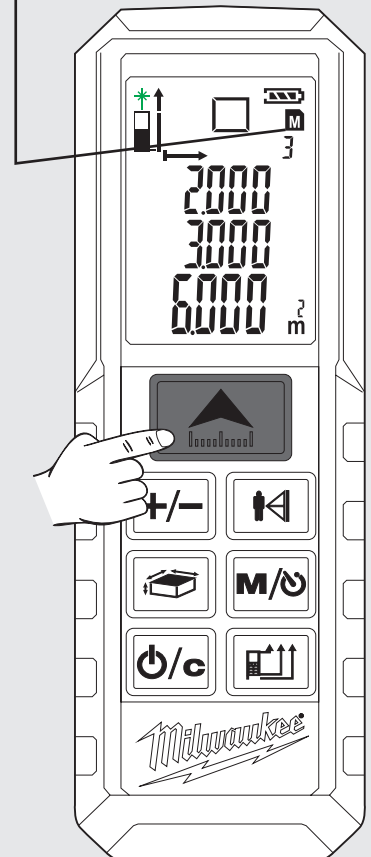

PRINCIPIËLE WERKING AAN DE HAND VAN EEN OPPERVLAKMETING (2)

6 Opgeslagen waarde oproepen

De toets **M/0** 2 sec. lang indrukken.
Toets **M/0** herhaaldelijk indrukken.

7 Geheugen verlaten

De toets **0/c** indrukken

8 Uitschakelen

De toets **0/c** 2 sec. lang indrukken
(het geheugen moet eerst worden verlaten).

- De opgeslagen waarden worden in de hoofdregel weergegeven.
- Het bijbehorende symbool wordt weergegeven en de meeteenheid knippert (knipperen wordt groen weergegeven).

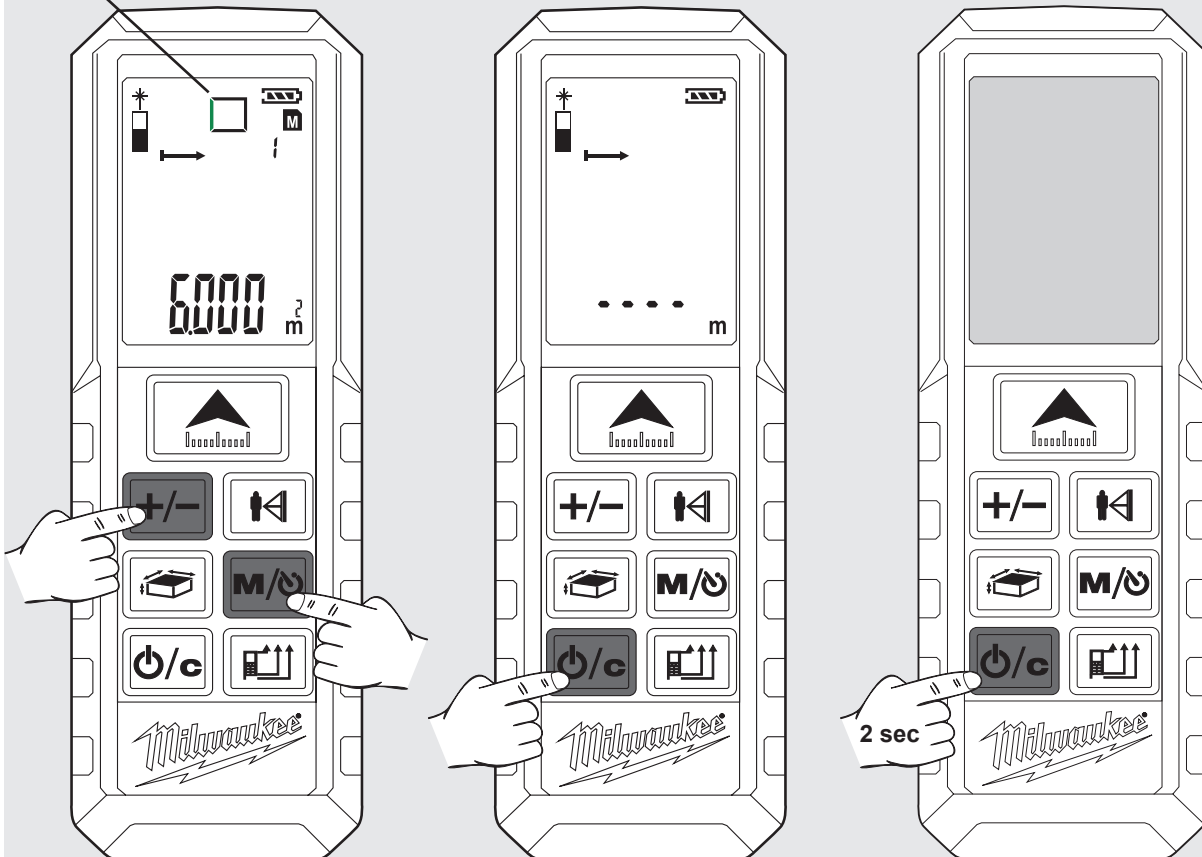

- Het toestel schakelt uit.
- Als gedurende 3 minuten geen toets wordt ingedrukt, schakelt het toestel automatisch uit.



INDHOLD

Vigtige sikkerheds- instruktioner.....	1
Tekniske data.....	2
Tiltænkt Formål.....	2
Fejlkode Tabel	2
Oversigt.....	3
Skift batteri.....	4
Hjørnestift	4
Bælteclips	4
Funktionstast, pythagoras, målreference	5
Enkelt afstandsmåling	6
Konstant måling / minimum-maksimum måling.....	7
Additions- / subtraktionsmåling.....	8
Arealmåling.....	9
Volumenmåling.....	10
Indirekte måling (pythagoras 1).....	11
Indirekte måling (pythagoras 2).....	12
Indirekte måling (pythagoras 3).....	13
Måling af vægareal (scenario 1).....	14
Måling af vægareal (scenario 2).....	15
Timer	16
Hukommelse.....	16
Grundlæggende funktionsmåde vist med et eksempel på en arealmåling (1).....	17
Grundlæggende funktionsmåde vist med et eksempel på en arealmåling (2).....	18

VIGTIGE SIKKERHEDS- INSTRUKTIONER

  Brug ikke produktet før du har læst sikkerhedsinstruktionerne og brugervejledningen på vedlagte CD.

Laserklassificering

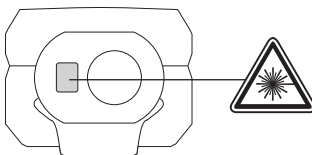

ADVARSEL:

Det er et Klasse 2 laserprodukt i overensstemmelse med EN60825-1:2014.



λ 650 nm P<1 mW

Advarsel:

Undgå en direkte synskontakt. Laserstrålen kan forårsage "blitz blindhed" og føre til en kortvarig blænding.

Se aldrig ind i laserstrålen og ret den ikke unødigt mod andre personer.

Blænd ikke andre personer.

Advarsel:

Betjen ikke laserapparatet i nærheden af børn eller tillad ikke børn at benytte laserapparatet.

OBS!! En reflekterende overflade kunne reflektere laserstrålen tilbage til brugeren eller andre personer.

Hold arme og ben i sikker afstand fra bevægelige dele.

Udfør regelmæssige testmålinger. Især før, under og efter vigtige målinger.

Vær opmærksom på fejl-målinger, hvis produktet er defekt, eller hvis det er blevet tabt eller er blevet misbrug eller modificeret.

Advarsel: Anvendelse af andre styreelementer, indstillinger eller procedurer end angivet her i manualen kan føre til farlig strålebelastning.

Laserafstandsmåleren har grænser for sit anvendelsesområde. (Se afsnittet "Tekniske data"). Det vil forårsage unøjagtigheder at forsøge at måle uden for det maksimale og minimale område. Bruges instrumentet ved ugunstige betingelser som hvis det er for varmt eller for koldt, meget kraftigt sollys, regn, sne, tåge eller andre sigtbegrænsende betingelser kan det føre til unøjagtige målinger.

Hvis laserafstandsmåleren kommer fra varme omgivelser til kolde (eller omvendt), så vent, indtil den har tilpasset sig til den nye omgivelsestemperatur.

Opbevar altid laserafstandsmåleren indendørs, beskyt den mod stød, vibrationer eller ekstreme temperaturer.

Beskyt laserafstandsmåleren mod støv, fugtighed og høj luftfugtighed. Dette kan ødelægge indvendige komponenter eller påvirke nøjagtigheden.

Brug ikke aggressive rengøringsmidler eller opløsningsmidler. Rengør kun instrumentet med en ren, blød klud.

Undgå at laserafstandsmåleren udsættes for kraftige stød eller at tabe den. Instrumentets nøjagtighed skal kontrolleres, hvis det er faldet ned eller har været udsat for andre mekaniske belastninger.

Nødvendige reparationer på dette laserapparat skal udføres af autoriserede fagfolk.

Brug ikke produktet i områder med eksplosions-fare eller under barske forhold.

Brug kun opladere anbefalet af producenten til opladning af batterierne.

 Udtjente batterier, affald af elektrisk og elektronisk udstyr må ikke bortskaffes sammen med husaffald. Udtjente batterier, affald af elektrisk og elektronisk udstyr skal indsamles og bortskaffes særskilt.

Fjern udtjente batterier, udtjente akkumulatorer og lysmidler fra udstyret, inden det bortskaffes.

Spørg efter genbrugsstationer og indsamlingssteder hos de lokale myndigheder eller din fagforhandler.

Alt efter de lokale bestemmelser kan detailhandlende være forpligtede til gratis at tage brugte batterier, affald af elektrisk og elektronisk udstyr tilbage.

Bidrag til at nedbringe behovet for råmaterialer ved at genbruge og genanvende dine udtjente batterier, affald af elektrisk og elektronisk udstyr.

Udtjente batterier (især lithium-ion-batterier), affald af elektrisk og elektronisk udstyr indeholder værdifulde, genanvendelige materialer, som kan have en negativ effekt på miljøet og dit helbred ved ikke miljørigtig bortskaffelse.

Slet inden bortskaffelsen personrelaterede data, som måtte befinde sig på dit affald af udstyret.

 Europæisk overensstemmelsesmærke

 Britisk overensstemmelsesmærkning

 Ukrainisk konformitetsmærke

 Eurasisk konformitetsmærke

TEKNISKE DATA

Kapslingsklasse	IP54 (støv- og stænkvandsbeskyttet)
Modtagelinse	14 mm
Fokus	35 mm
Maks. måleområde	50 meter (tolerance: 55m)
Min. måleområde	0,05 meter
Absolut nøjagtighed @ < 10m	± 1,5 mm (maks.)
Gentagelsesnøjagtighed @ < 10m	± 1,5 mm (typisk maks. 2σ)
Gentagelsesnøjagtighed @ > 10m	stigning ± 0,25 mm / meter (typisk maks. 2σ)
Måletid	0,5 s
Display type	LCD (22,7 mm x 31 mm)
Strømforsyning	AAA 2x (alkaline batteri)
Batteriets levetid	10000 (enkelt måling)
Laser udgangseffekt	0,6 mW ~ 0,95 mW (klasse 2, 650nm)
Laserpunktstørrelse	25 x 30 mm @ 16 m (maks.)
Laserklasse	2
Lasertype	650 nm, < 1 mW
Laserstråle vertikalvinkel	+1 grad
Laserstråle horisontalvinkel	±1 grad
Automatisk slukning af instrumentet	180 sekunder
Automatisk slukning af laser	30 sekunder
Arbejdstemperatur område	-10°C op til +50°C
Opbevaringstemperatur område	-25°C op til +70°C
Vægt uden batteri	80 g

TILTÆNKT FORMÅL

Laserafstandsmåleren er egnet til måling af afstande og hældninger.

Produktet må ikke anvendes på anden måde og til andre formål end foreskrevet.

FEJLKODE TABEL

Kode	Beskrivelse	Løsning
Err01	Uden for måleområdet	Foretag målingen i det korrekte område.
Err02	Reflekterende signal er for svagt	Vælg en bedre overflade.
Err03	Uden for visningsområdet (maks. værdi: 99.999) f.eks. er resultatet af areal eller volumen uden for visningsområdet	Kontrollér, at værdier og trin er korrekte.
Err04	Fejl i pythagoras beregningen	Kontrollér, at værdier og trin er korrekte.
Err05	Batteri er svagt	Sæt nye batterier i.
Err06	Uden for arbejdstemperaturens område	Foretag målingen inden for det fastlagte område for arbejdstemperaturen.
Err07	Omgivelseslyset er for stærkt	Sørg for at målområdet er mørkere.

Pythagoras
Højdeforskel

Areal / volumen
Indirekte arealmåling

Målereference

Batteristatus

Afstandsmåling

Hukommelse

Minimum / maksimum for konstant måling

Timer

Addition / subtraktion

Konstant måling

Foreløbige værdier

Totalværdi

TÆND / MÅL

- ▶ Tænd
- ▶ Mål
- ▶ Konstant måling (tryk i 2 sek.)
Min. / maks. funktion

ADDITION / SUBTRAKTION

- ▶ Læg værdi til
- ▶ Navigér i hukommelsen

AREAL / VOLUMEN

- ▶ Areal (tryk 1x)
- ▶ Volumen (tryk 2x)
- ▶ Indirekte arealmåling (tryk 3x / 4x)

TÆND FOR INSTRUMENTET

- ▶ Tænd
- ▶ Sluk (tryk 2 sek.)
- ▶ Slet

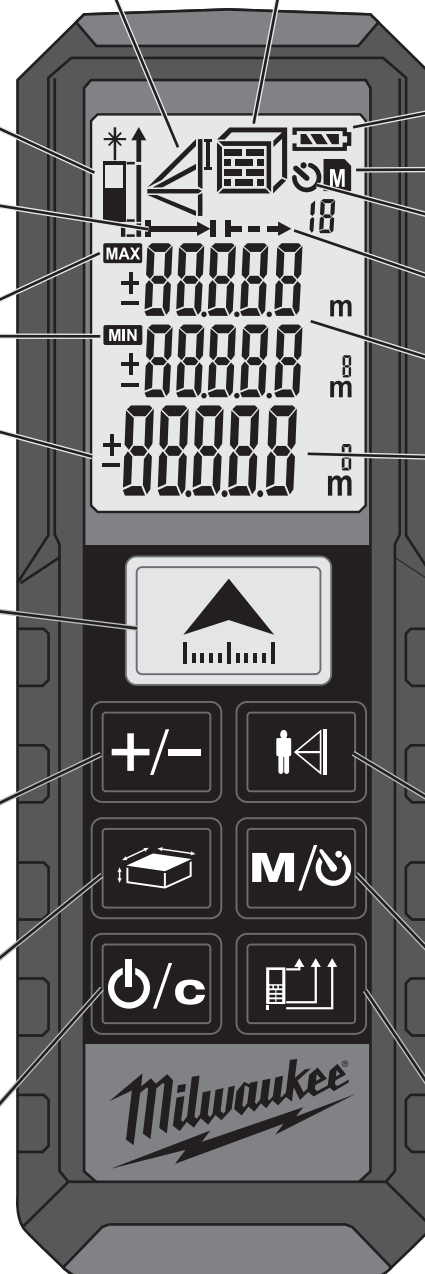

PYTHAGORAS

- ▶ Pythagoras 1 (tryk 1x)
- ▶ Pythagoras 2 (tryk 2x)
- ▶ Pythagoras 3 (tryk 3x)

HUKOMMELSE

- ▶ Timer 3-15 sek. (tryk 1x)
- ▶ Hukommelse 1-20 (tryk 1x i 2 sek.)
- ▶ Hent gemte værdier (tryk gentagne gange)

SKIFT MÅLEREFERENCE

- ▶ Forkant
- ▶ Bagkant
- ▶ Hjørnestift

SKIFT BATTERI

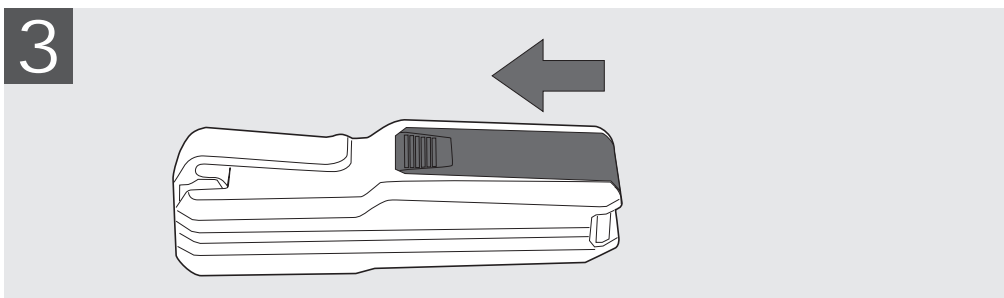
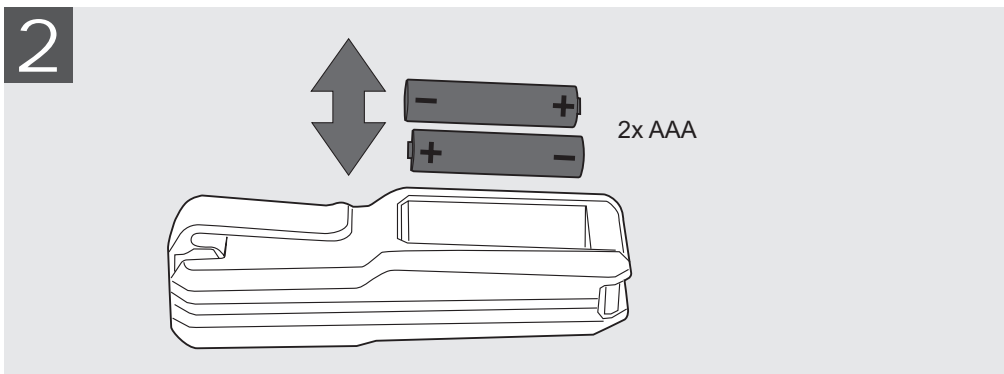
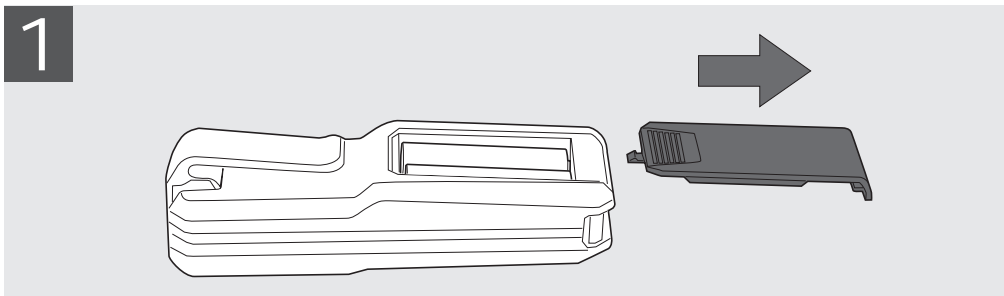
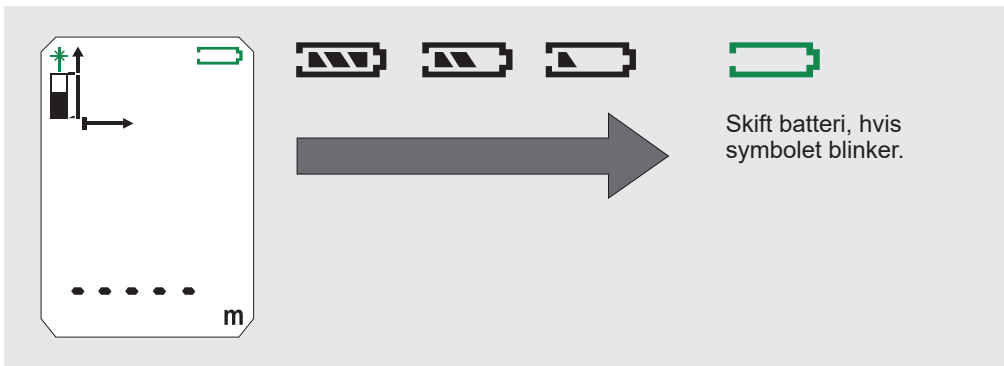

HJØRNESTIFT

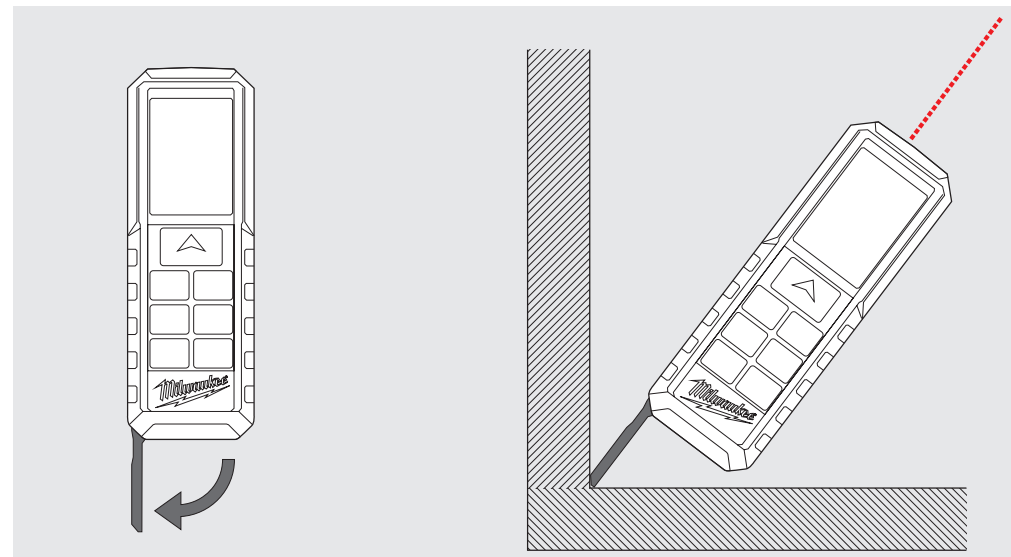

BÆLTECLIPS

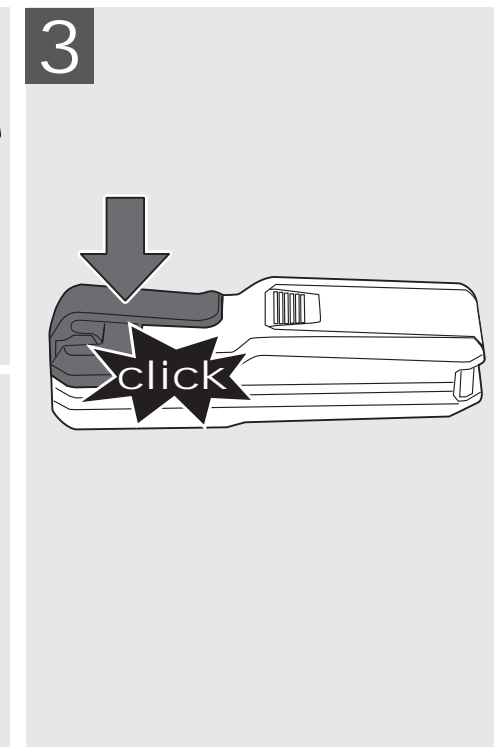
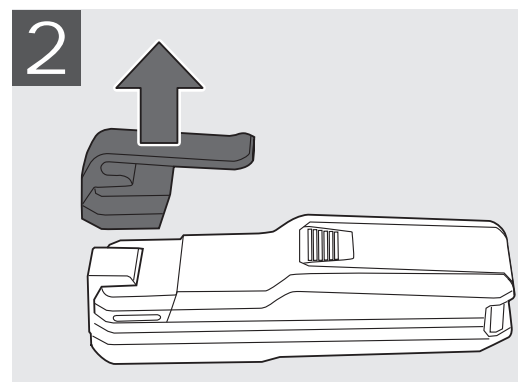
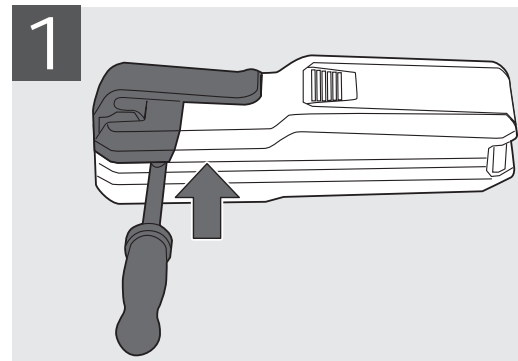

FUNKTIONSTAST, PYTHAGORAS, MÅLEREFERENCE

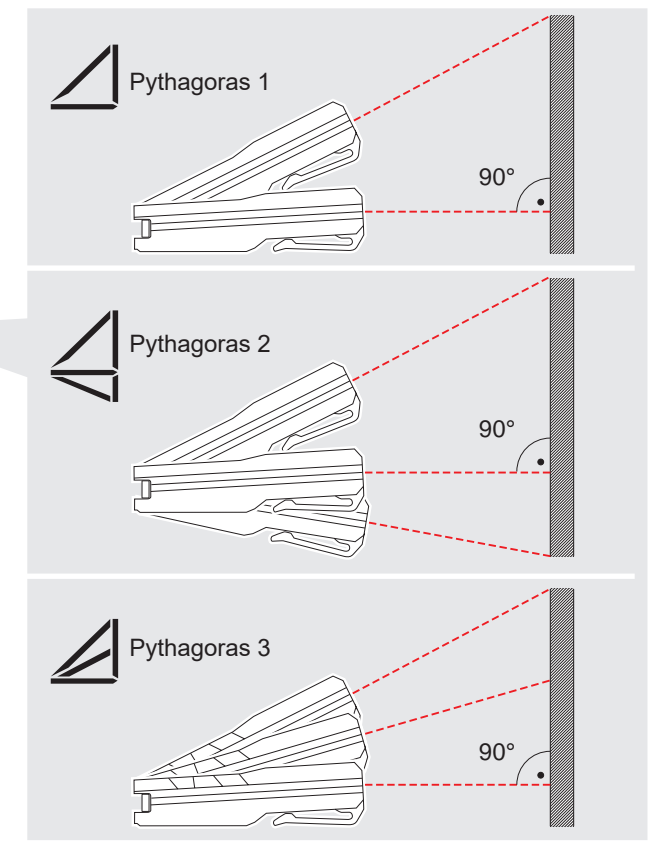
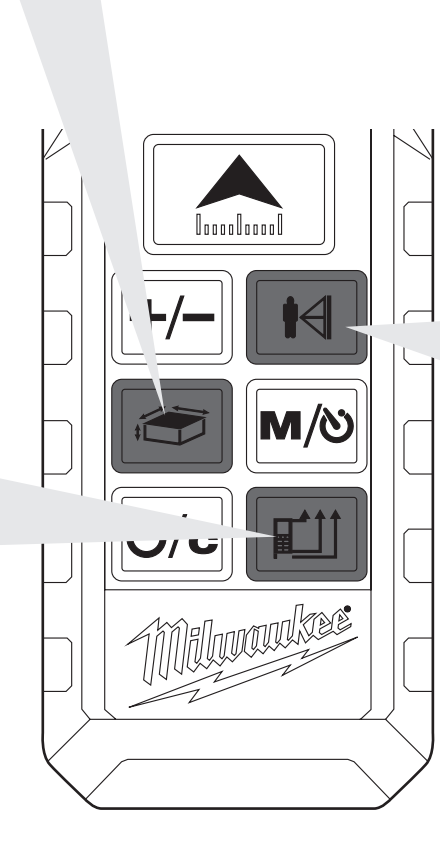
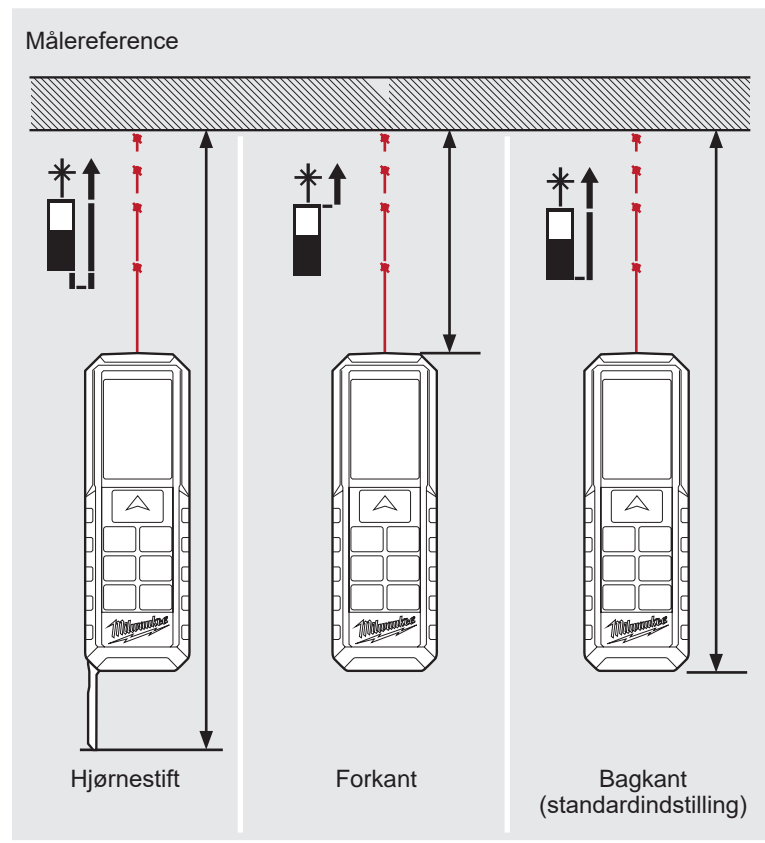
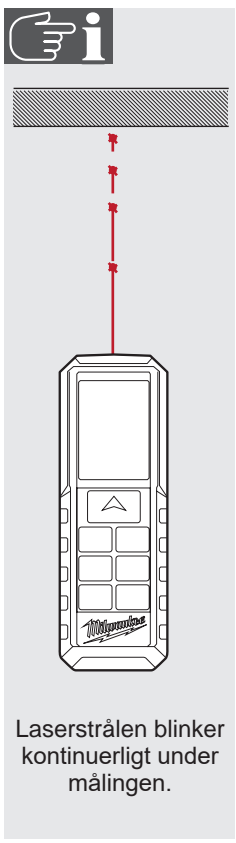
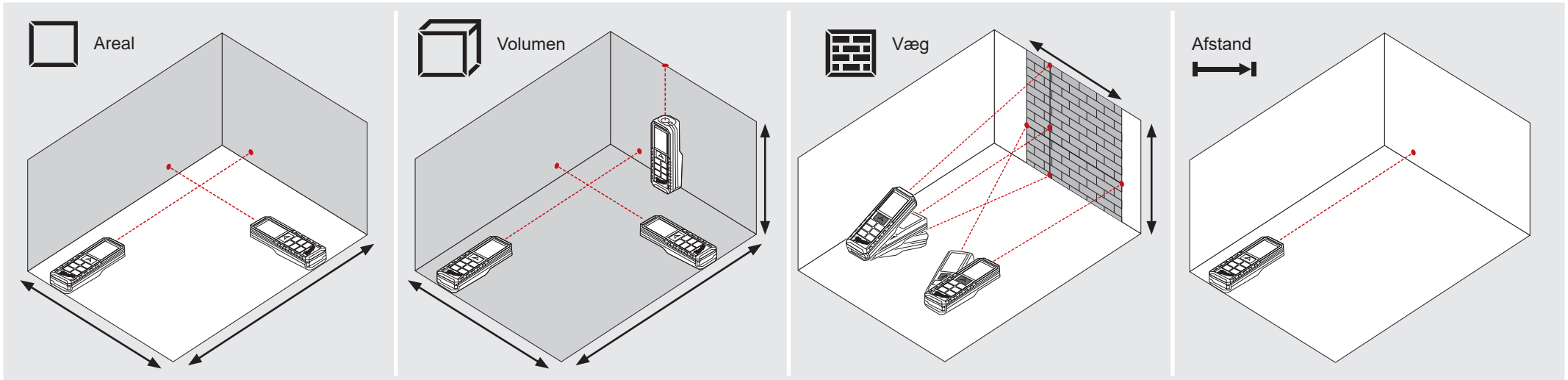

ENKELT AFSTANDSMÅLING

0

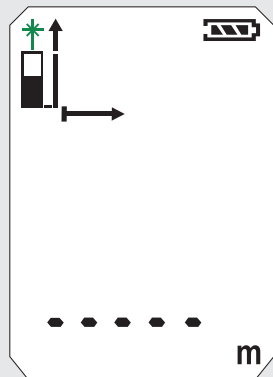

1

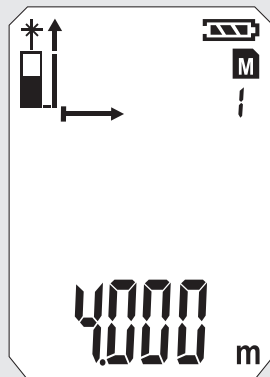

2

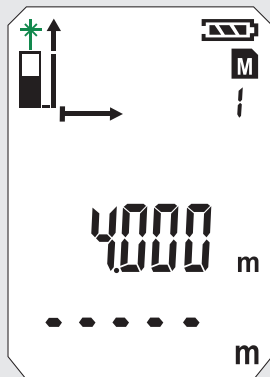

3

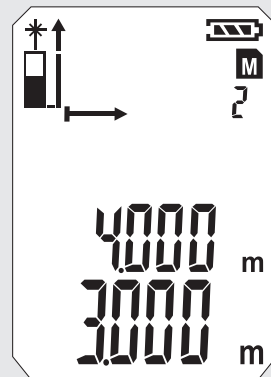

4

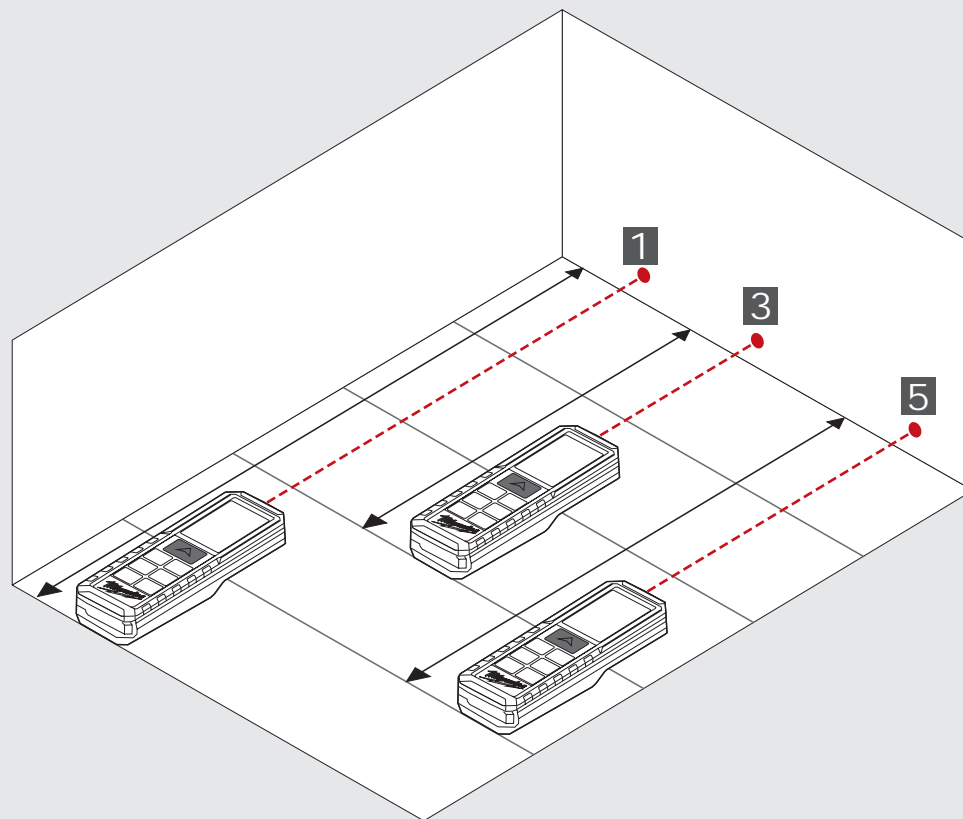
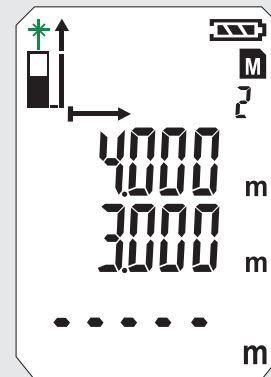

5

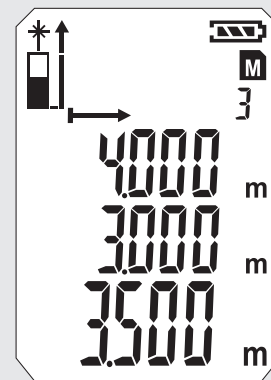

KONSTANT MÅLING / MINIMUM-MAKSIMUM MÅLING

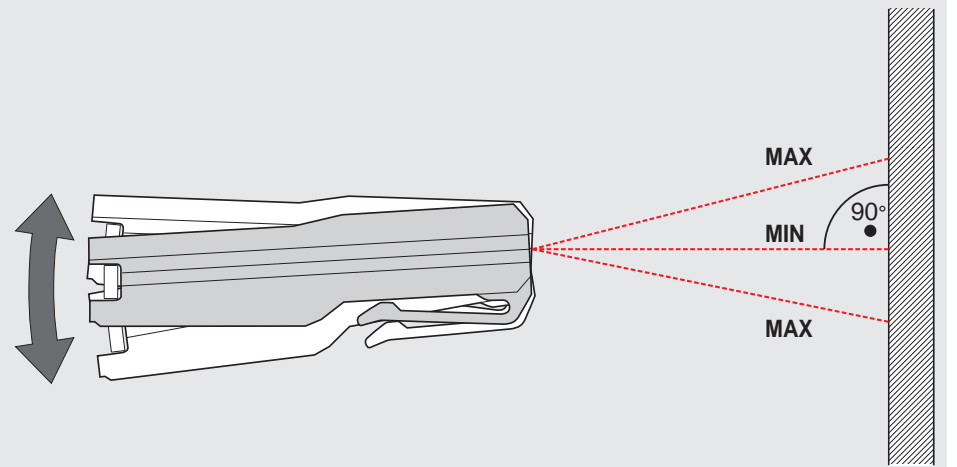
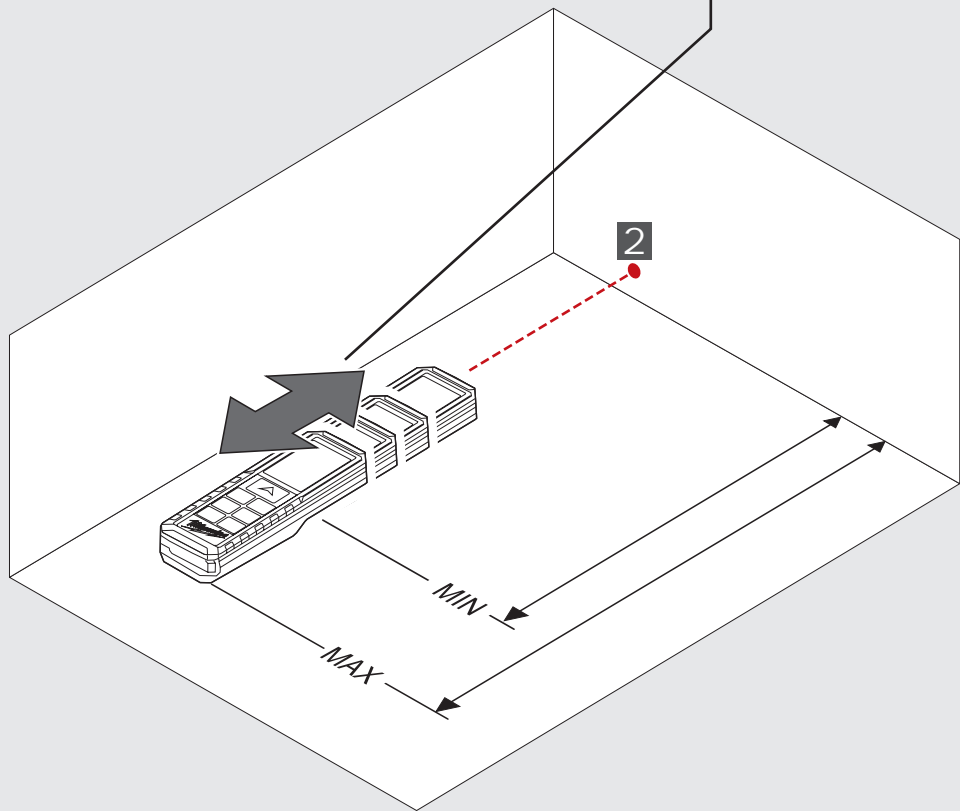
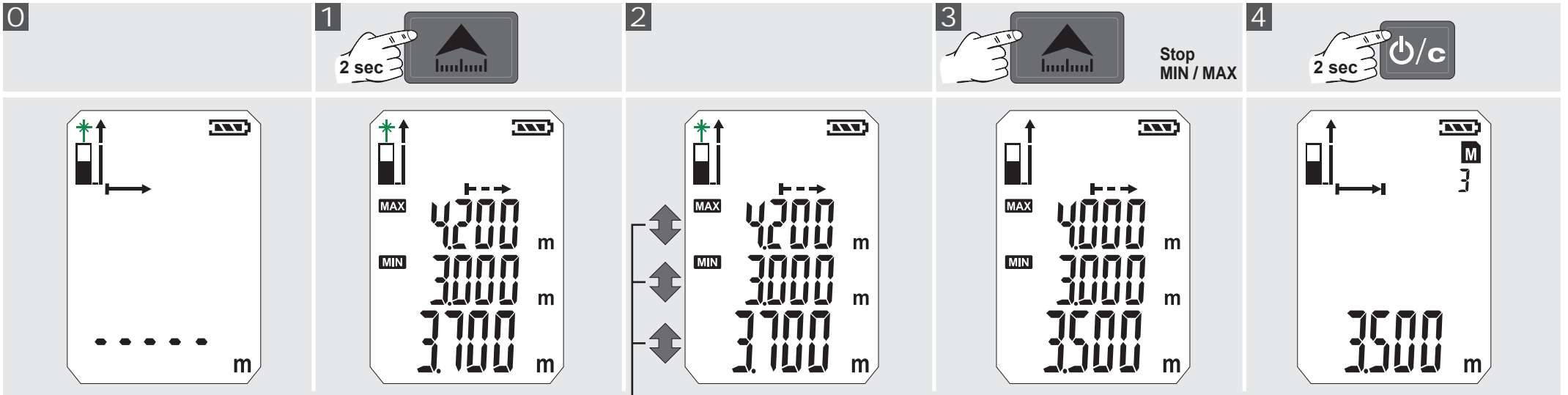

0

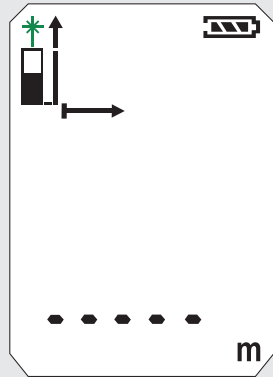

1

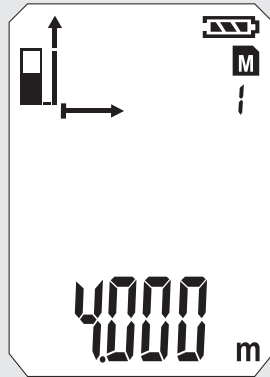

2

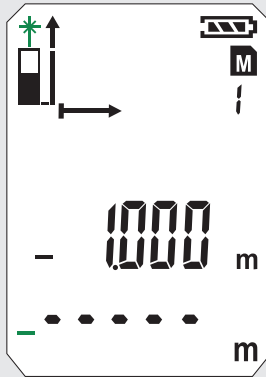

3

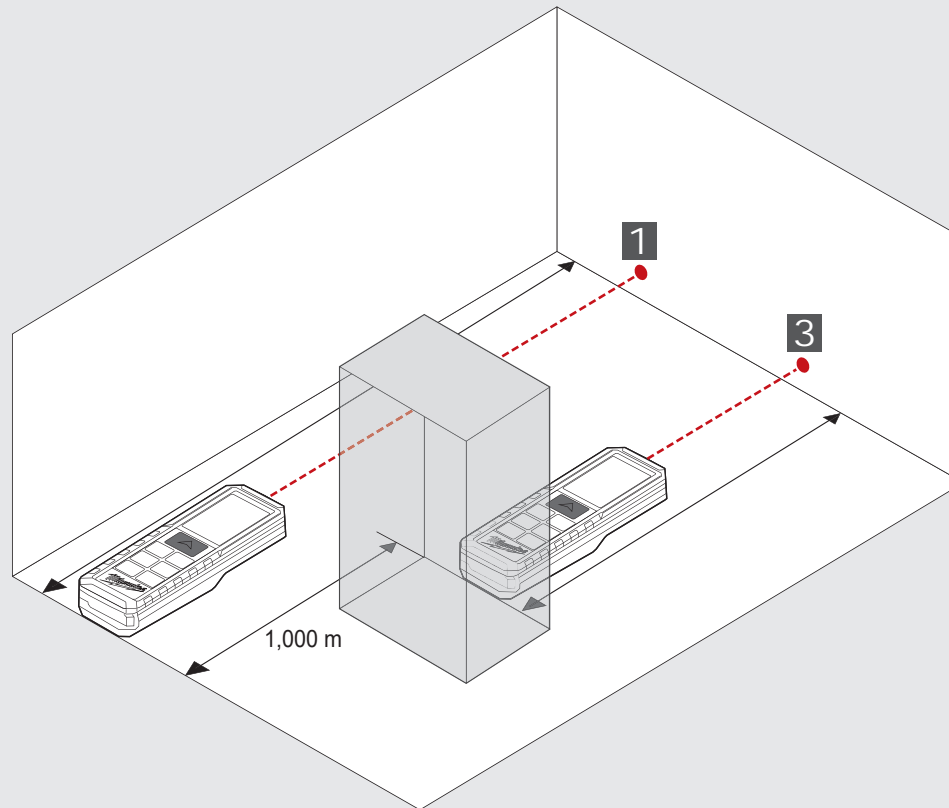
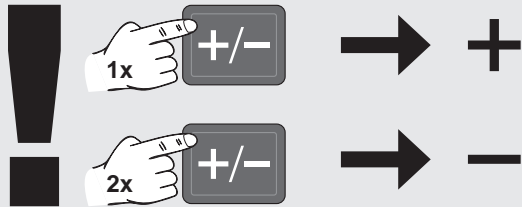
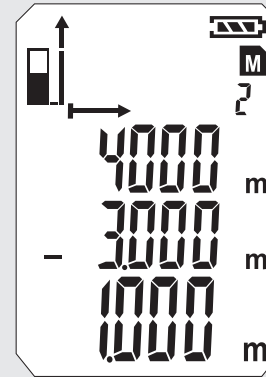

0



1



2

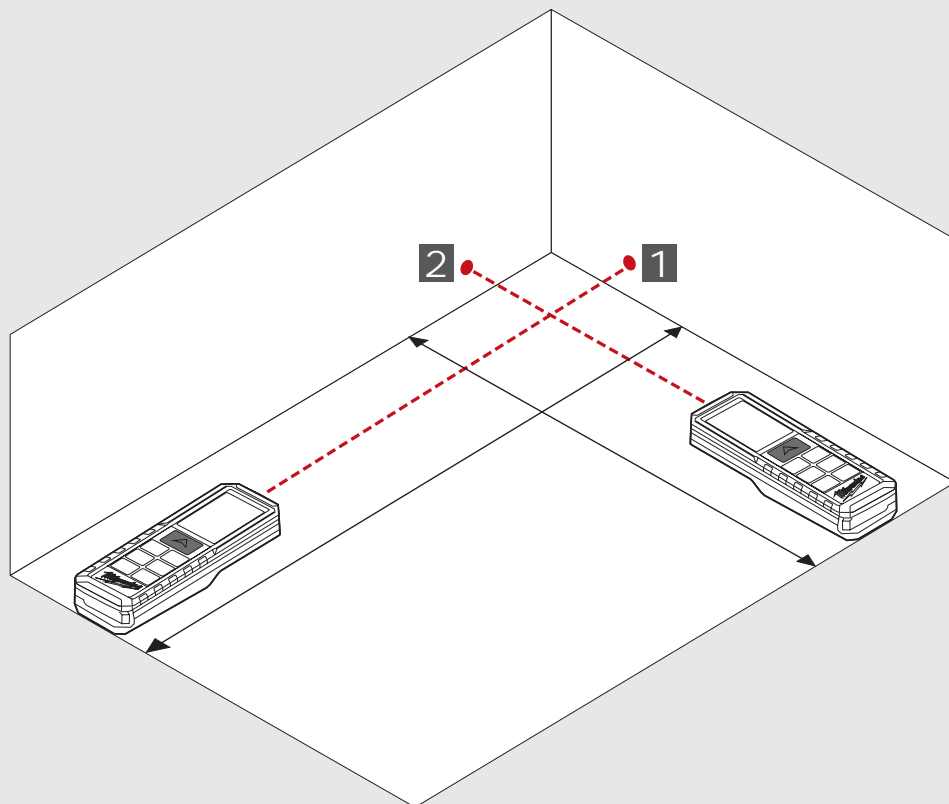
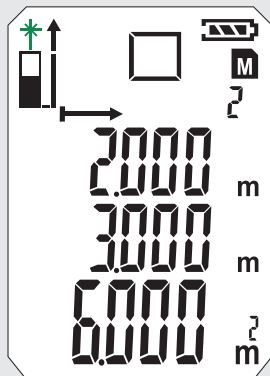
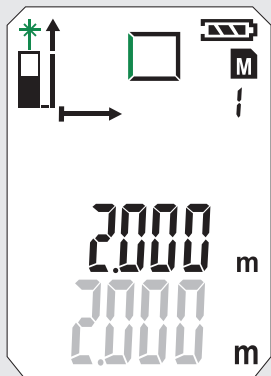
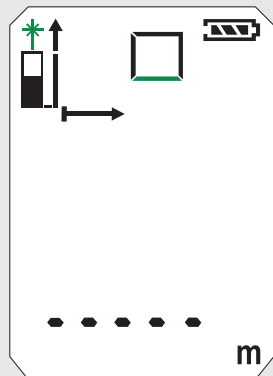

VOLUMENMÅLING

0



1



2



3

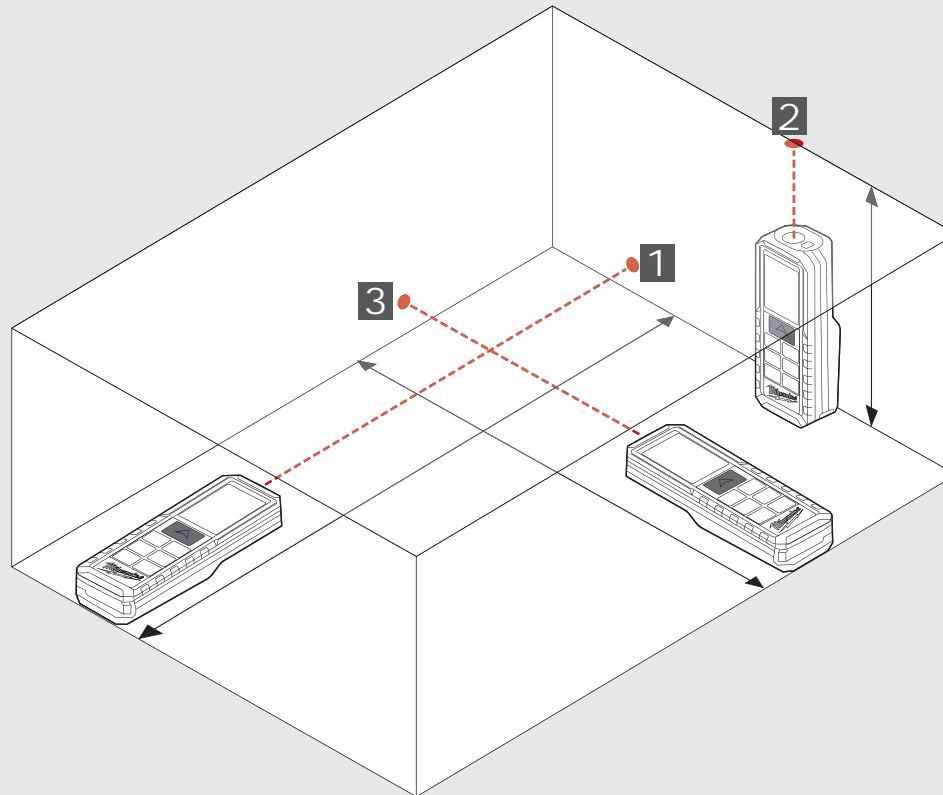
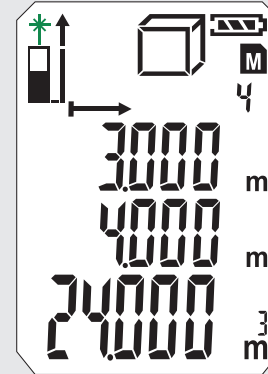
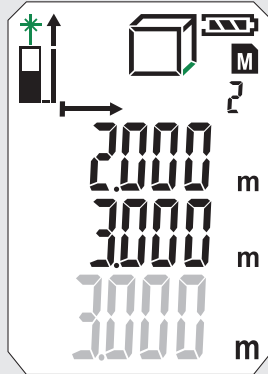
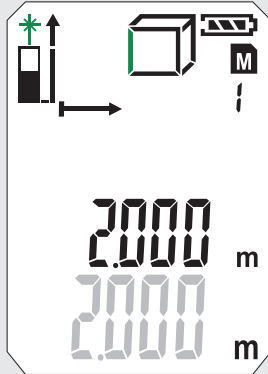
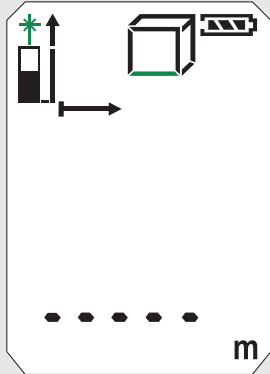

INDIREKTE MÅLING (PYTHAGORAS 1)

0



1



2

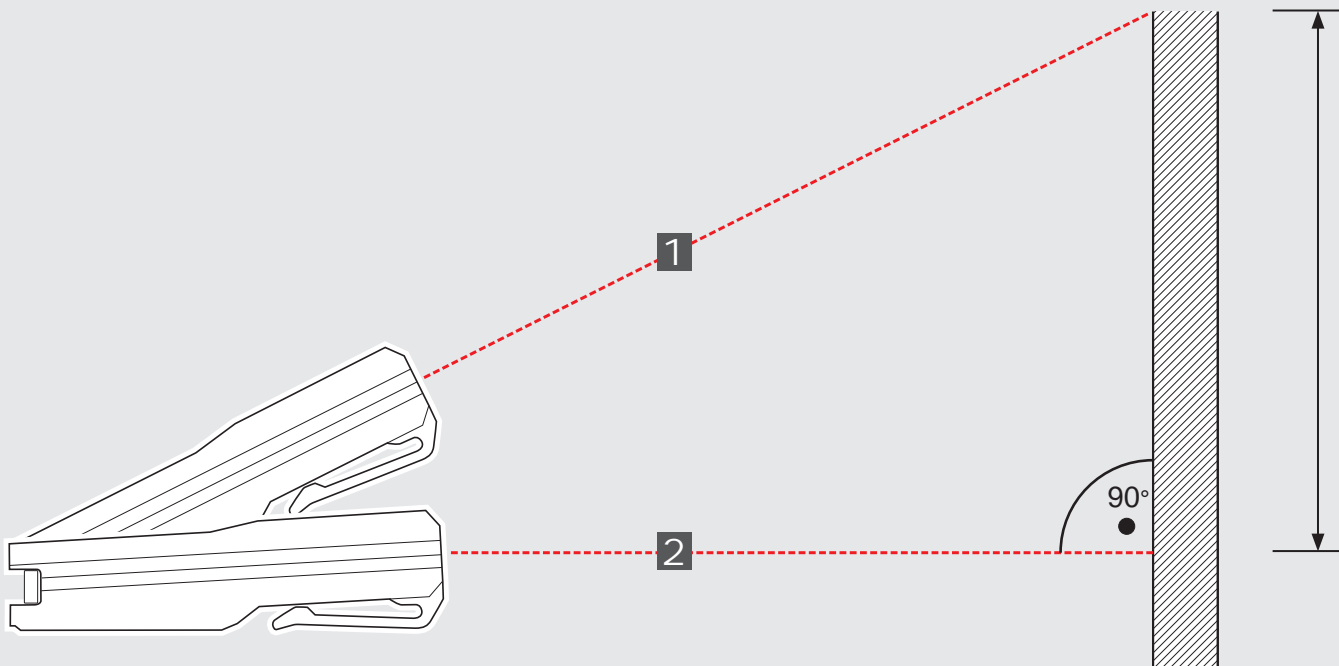
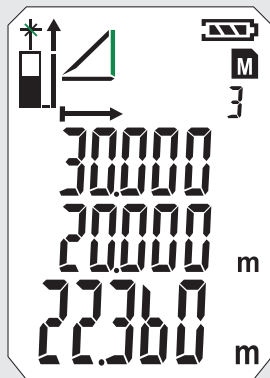
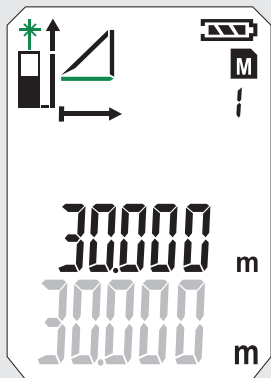
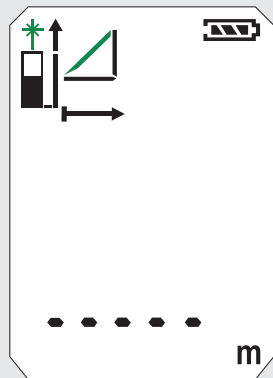

INDIREKTE MÅLING (PYTHAGORAS 2)

0



1







2

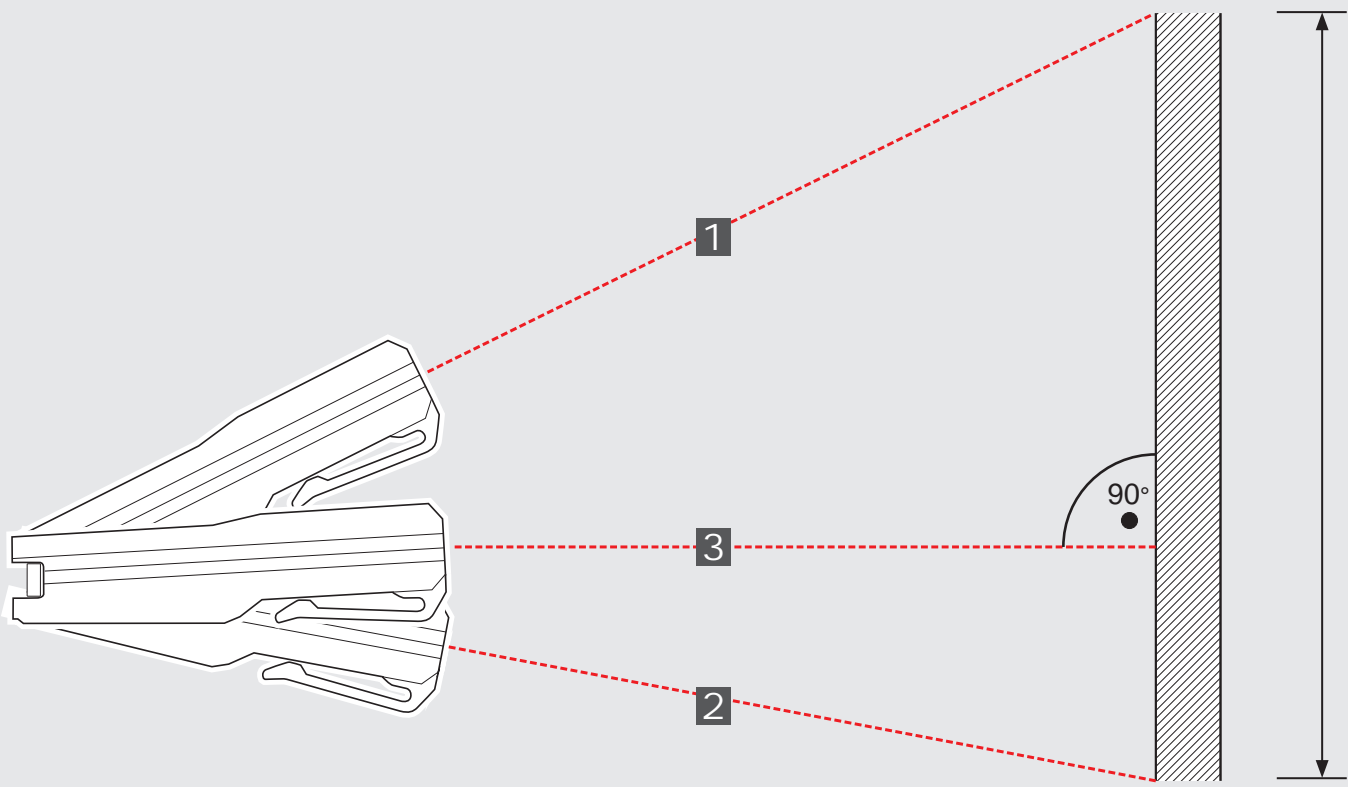
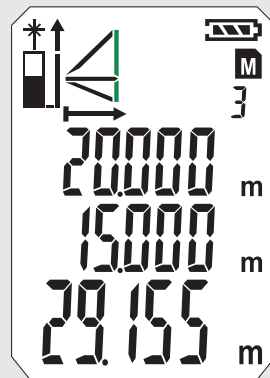
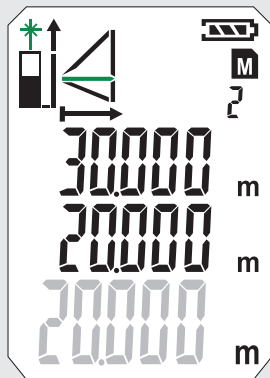
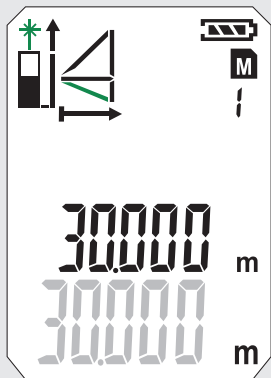
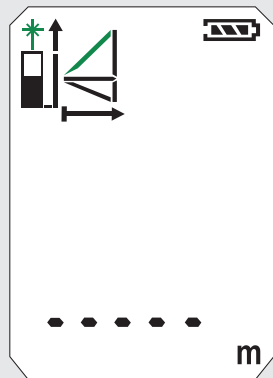

3





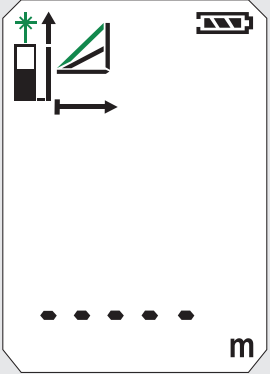
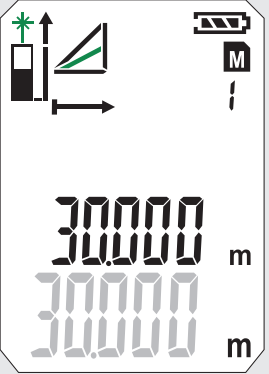
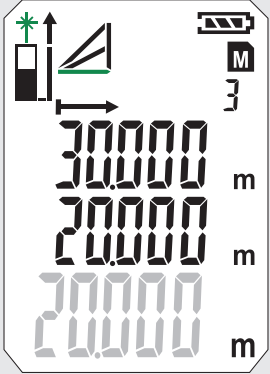
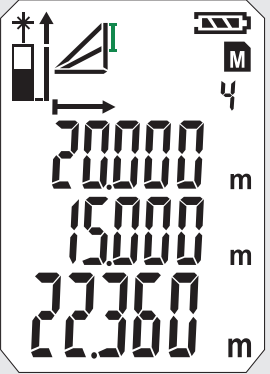

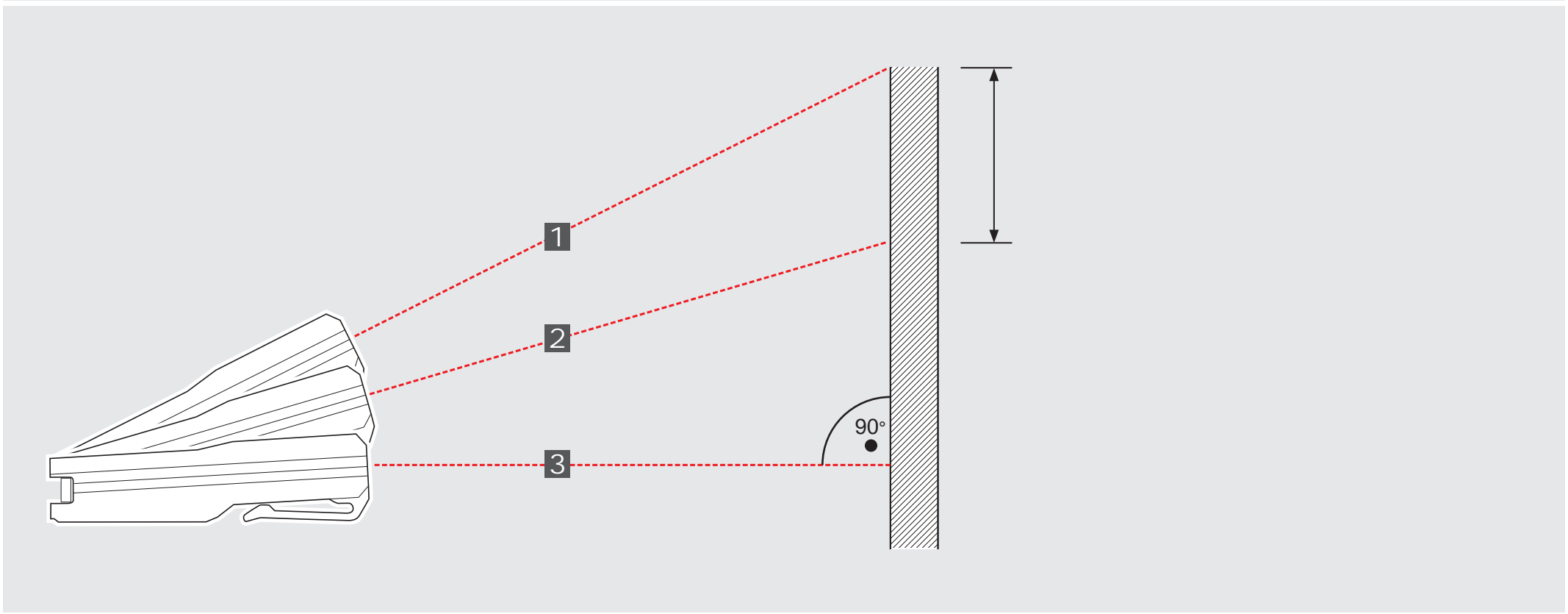
INDIREKTE MÅLING (PYTHAGORAS 3)

<p>1</p> 	<p>2</p> 	<p>3</p> 	<p>4</p> 
			

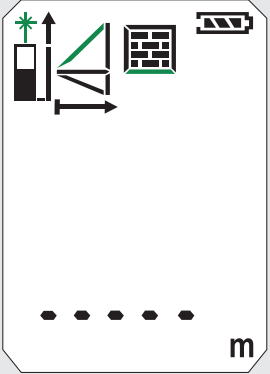
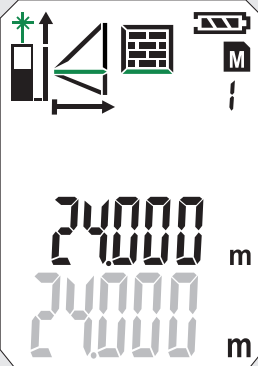
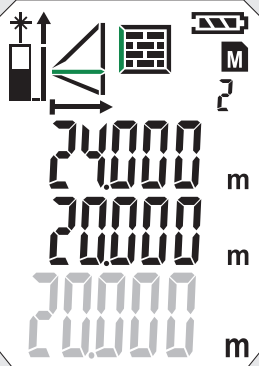
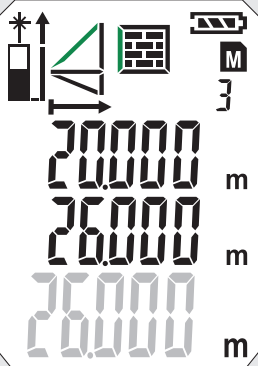
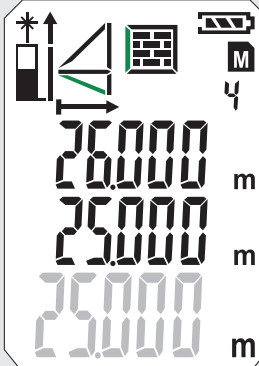

MÅLING AF VÆGAREAL (SCENARIO 1)

<p>0</p> 	<p>1</p> 	<p>2</p> 	<p>3</p> 	<p>4</p> 
				

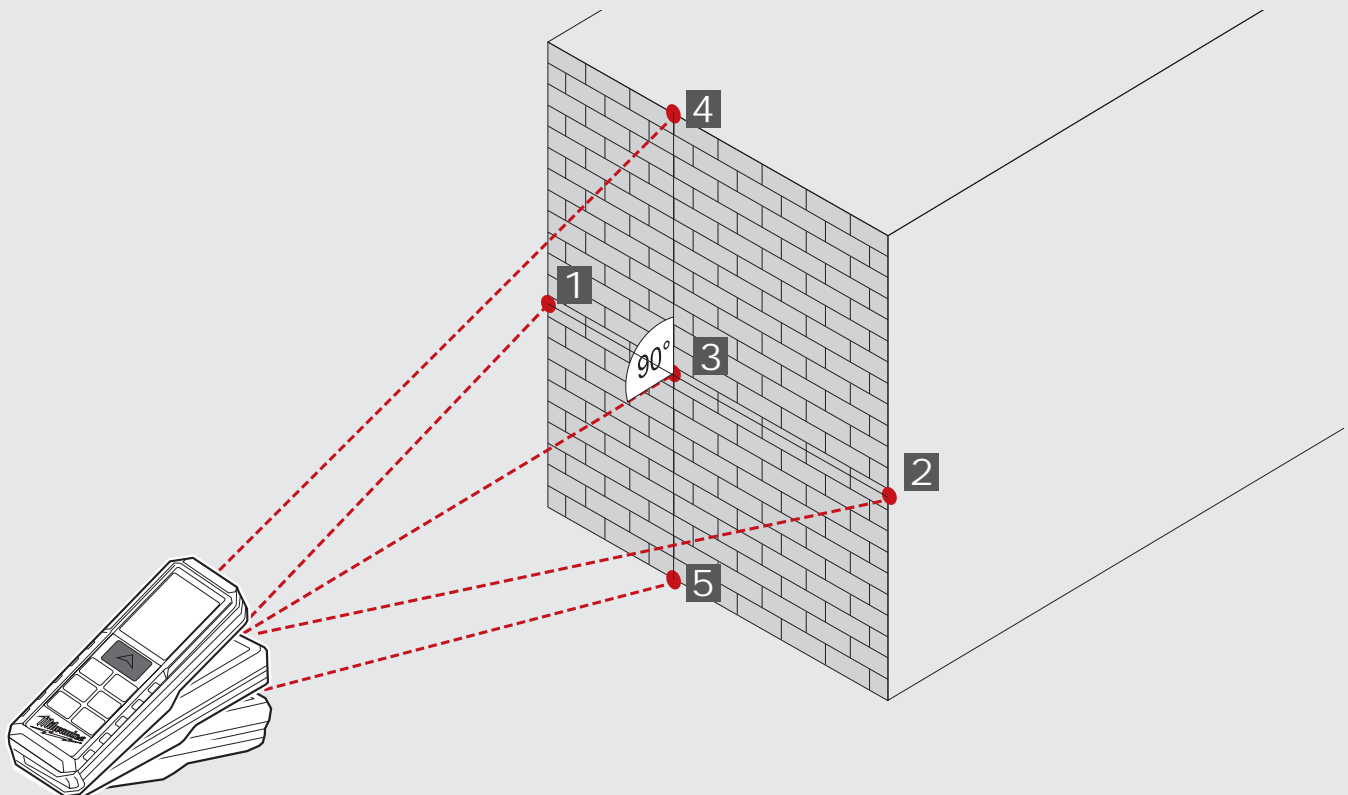

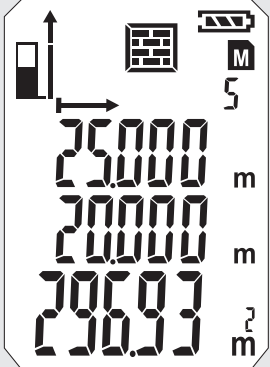







Diagram illustrating the measurement process on a wall. The calculator is positioned at the bottom left. Red dashed lines indicate the measurement path from the calculator to points 1, 2, 3, 4, and 5 on the wall. A 90-degree angle is marked between points 1 and 3.

5



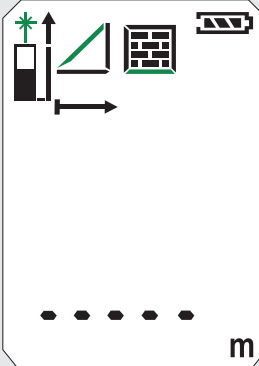
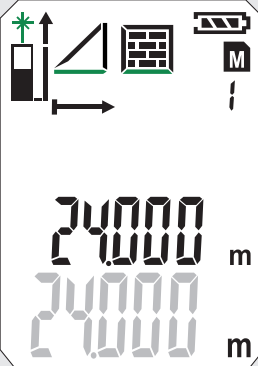
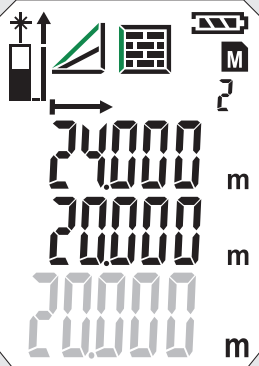
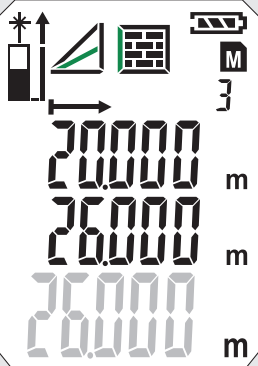
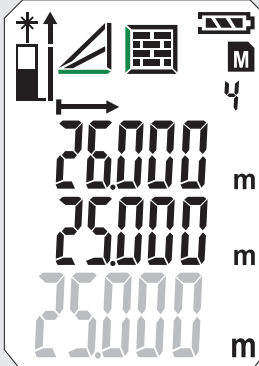

MÅLING AF VÆGAREAL (SCENARIO 2)

<p>0</p> 	<p>1</p> 	<p>2</p> 	<p>3</p> 	<p>4</p> 
				

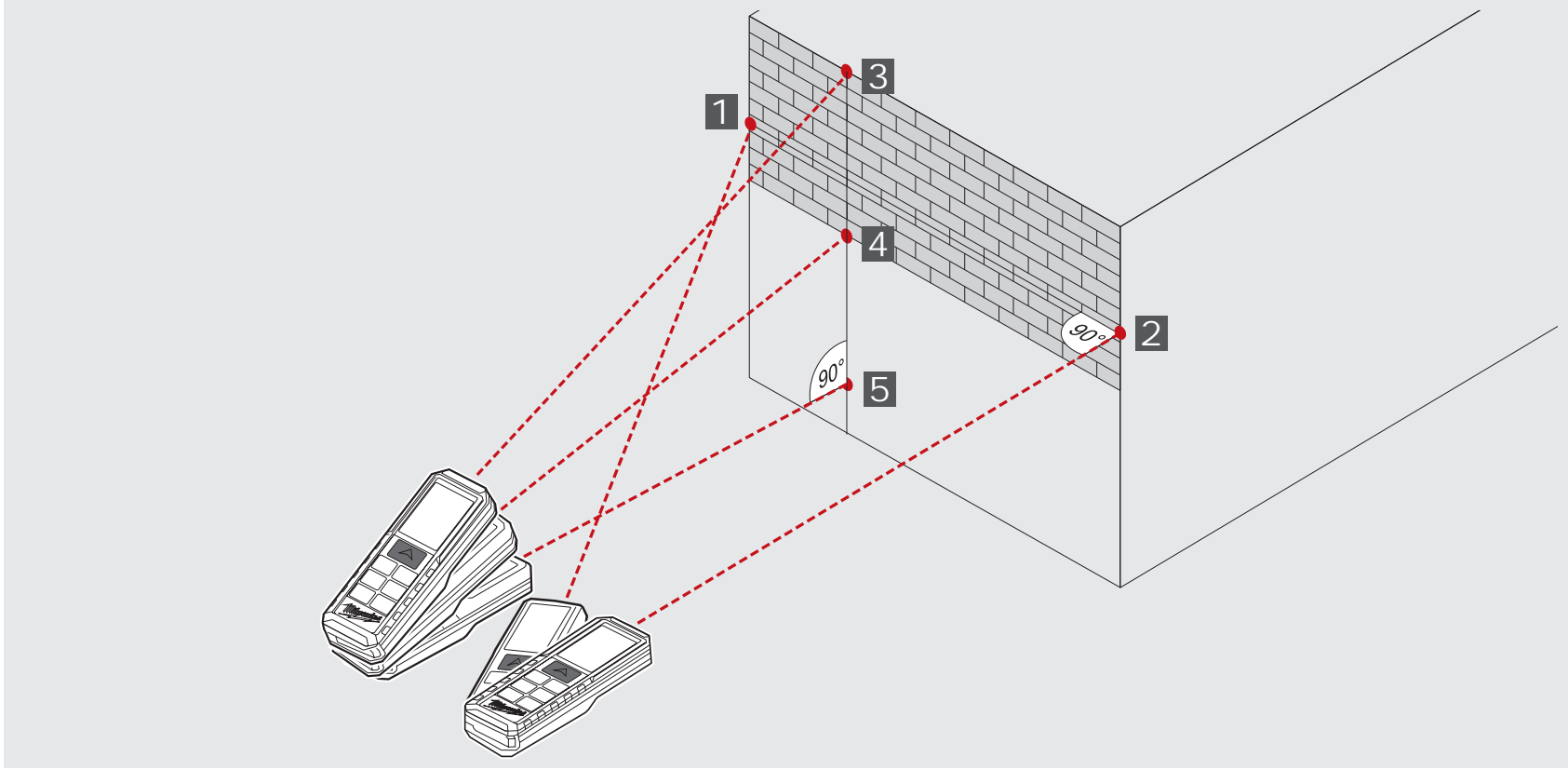

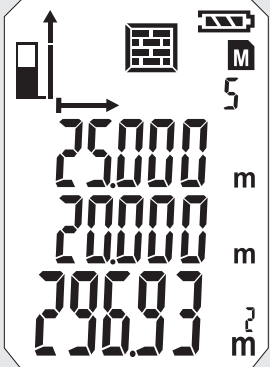

5





TIMER

Med timeren kan målingen startes forsinket, sådan at der f.eks. kan placeres en komponent i målestrålen.

Tryk på tasten .

- Symbolet vises
- Timeren kan indstilles på mellem 3 og 15 sek., når der trykkes på tasten .

Tryk på tasten .

- Sekunderne tælles ned, indtil målingen starter.
- Ved 0 starter målingen.

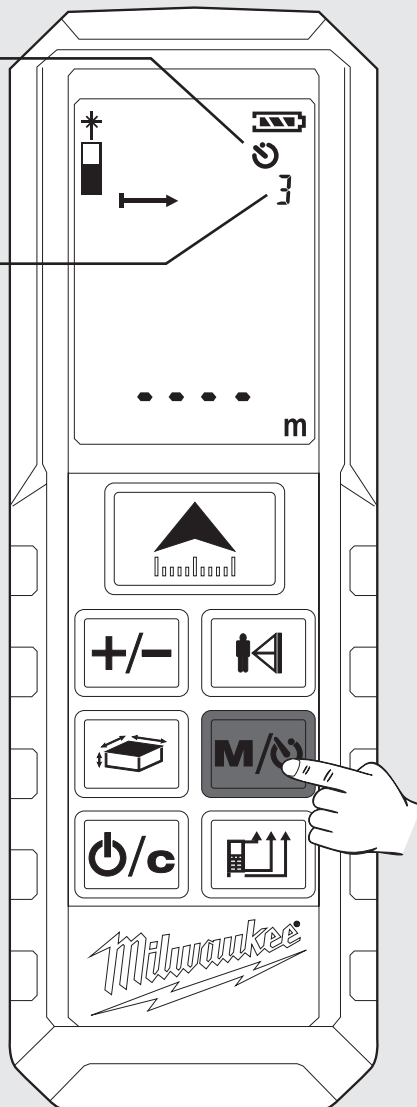

HUKOMMELSE

Måleværdierne gemmes konstant og automatisk i hukommelsen.

De gemte værdier kan hentes med tasten .

Tryk på tasten  i 2 sek.

- Symbol og hukommelsesnummer vises.
- Tilhørende målestørrelse vises.
- Den gemte værdi vises i hovedlinjen.
- Hent gemte værdier ved at trykke gentagne gange på tasten .

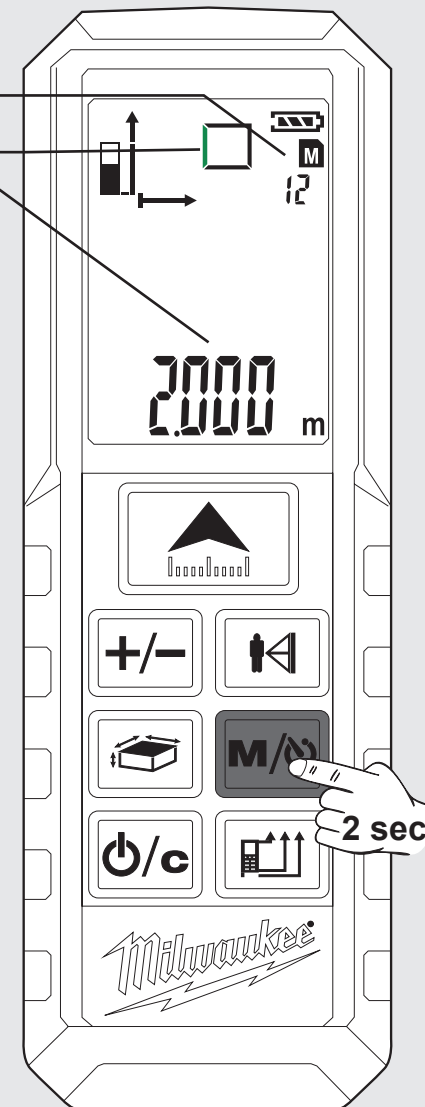

GRUNDLÆGGENDE FUNKTIONSMÅDE VIST MED ET EKSEMPEL PÅ EN AREALMÅLING (1)

1 Tænd

Tryk på tasten .
⚠ OBS! Laserstrålen er tændt!
 Peg ikke på personer!

2 Vælg målereferenc

Standardindstilling når instrumentet er tændt: bagkant

 Tryk 1x -> Hjørnestift
 Tryk 2x -> Forkant
 Tryk 3x -> Bagkant

3 Vælg funktion

Når instrumentet er tændt, står det altid på afstandsmåling.

 Tryk 1x - arealmåling

4 Mål længde

Justér instrumentet og tryk på tasten 

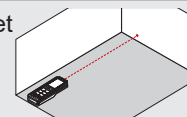

5 Mål bredde

Justér instrumentet og tryk på tasten 

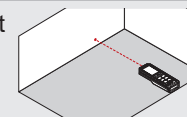

Lasersymbolet blinker (grøn blinken er vist).

Symbolet vises

- Symbolet vises
 - Målestørrelse blinker (grøn blinken er vist)

- Måleværdien vises kort i hovedlinjen.
 - Måleværdien hopper efter 1 sek. op i linjen oven over.
 - Måleværdien gemmes i hukommelsen under et fortløbende nummer.
 Den anden målestørrelse blinker. Instrumentet er parat til at måle den anden værdi.

- Måleværdien vises kort i hovedlinjen.
 - Måleværdien hopper efter 1 sek. op i linjen oven over.
 Måleværdien gemmes i hukommelse under et fortløbende nummer.
 - Resultatet vises i hovedlinjen og gemmes i hukommelsen under et fortløbende nummer.

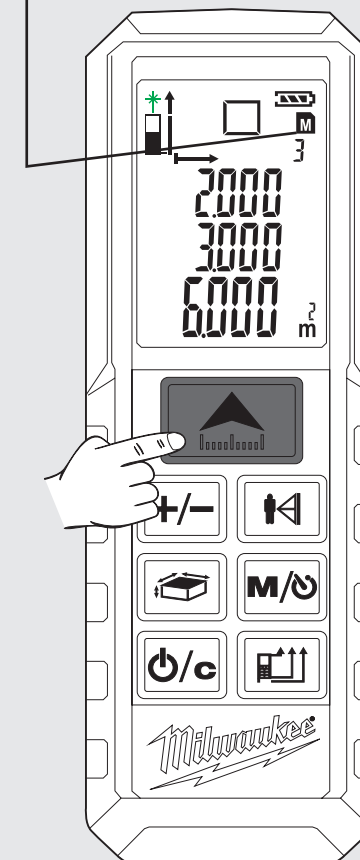
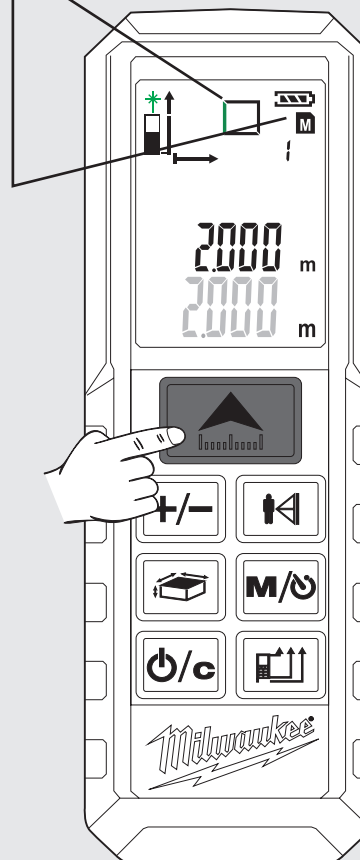
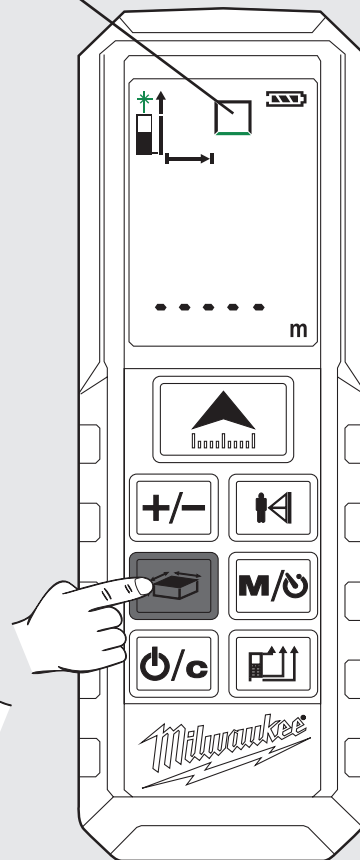
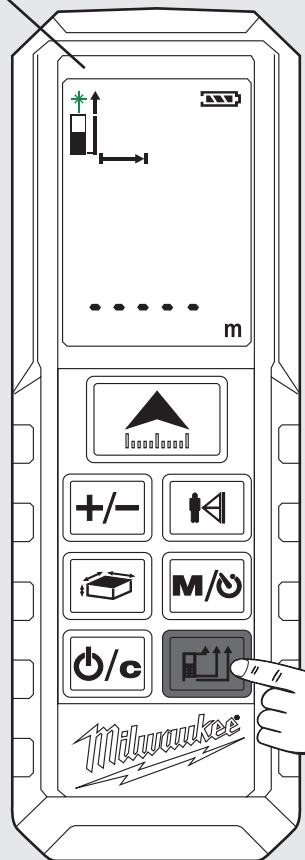
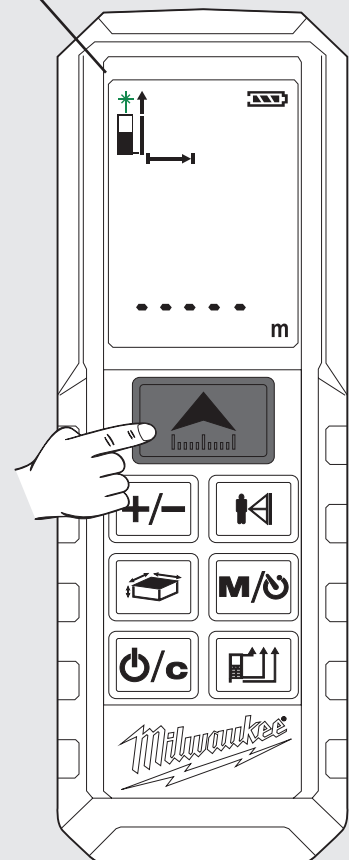

GRUNDLÆGGENDE FUNKTIONSMÅDE VIST MED ET EKSEMPEL PÅ EN AREALMÅLING (2)

6 Hent gemte værdier

Tryk på tasten **M/□** i 2 sek.

Tryk gentagne gange på tasten **M/□**.

7 Forlad hukommelsen

Tryk på tasten **□/c**

8 Sluk

Tryk på tasten **□/c** i 2 sek.
(Hukommelsen skal forlades forinden).

- De gemte værdier vises i hovedlinjen.

- Det tilhørende symbol vises og målestørrelsen blinker (grøn blinken er vist).

- Instrumentet slukker.

- Trykkes der ikke på en tast i 3 minutter, slukker instrumentet automatisk.

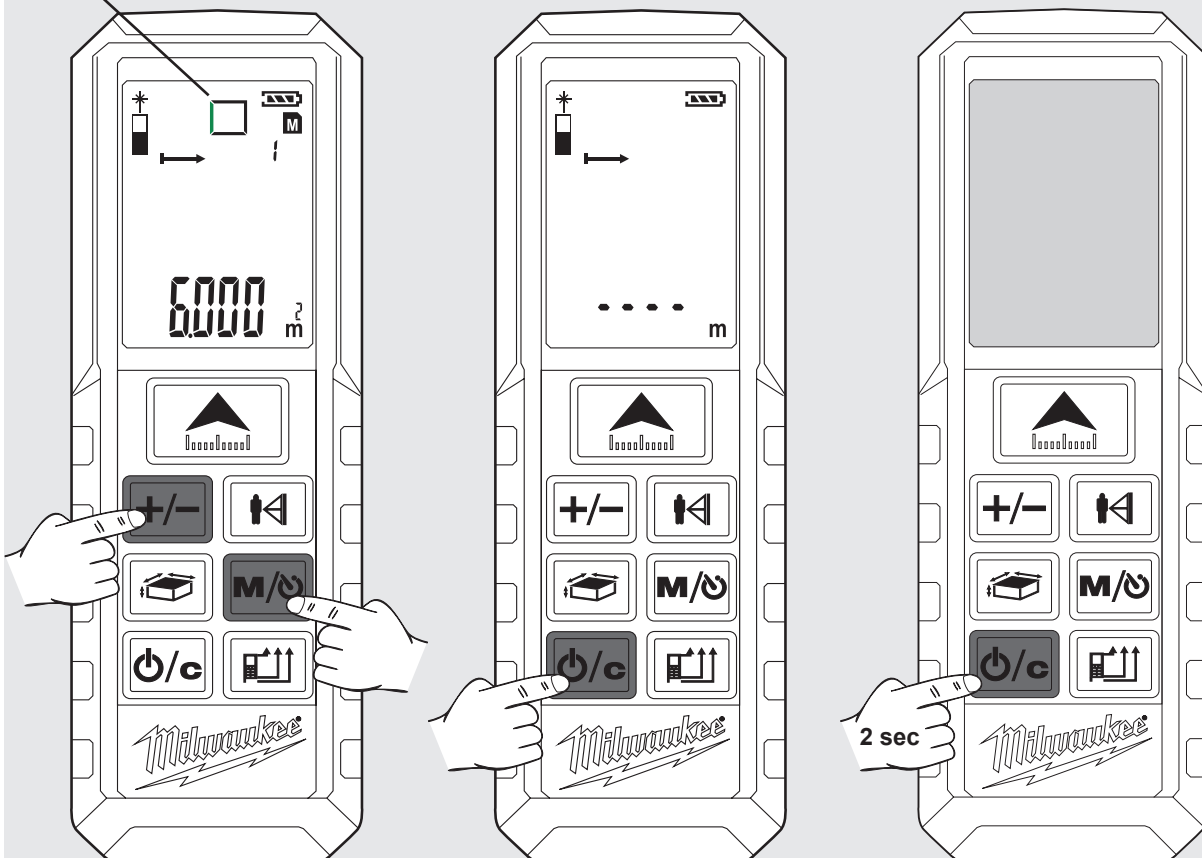

INNHOOLD

Viktige sikkerhetsinstruksjoner	1
Tekniske data.....	2
Formålsmessig bruk	2
Feilkode tabell	2
Oversikt	3
Skifte batteri.....	4
Hjørnestift	4
Belteholder	4
Funksjonstast, Pythagoras, Måle nivå.....	5
Enkel lengdemåling	6
Kontinuerlig måling / Minimum-Maksimum Måling	7
Addisjons- / Subtraksjonsmåling	8
Overflatemåling	9
Volummåling	10
Indirekte måling (Pythagoras 1).....	11
Indirekte måling (Pythagoras 2).....	12
Indirekte måling (Pythagoras 3).....	13
Veggflate måling (Scenario 1)	14
Veggflate måling (Scenario 2)	15
Tidsinnstiller.....	16
Minne.....	16
Grunnleggende bruksbeskrivelse av eksempel til en overflatemåling (1).....	17
Grunnleggende bruksbeskrivelse av eksempel til en overflatemåling (2).....	18

VIKTIGE SIKKERHETSINSTRUKSER



Ikke bruk produktet før du har studert sikkerhetsinstruksene og brukerhåndboken på vedlagte CD.

Laserklassifisering

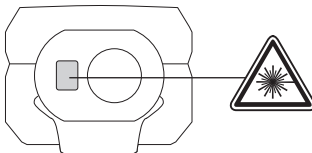

ADVARSEL:

Dette er et Class 2 laserprodukt i henhold til EN60825-1:2014.



λ 650 nm P<1 mW

OBS:

Unngå direkte øye kontakt. Laserstrålen kan gi blitzer i øynene, noe som kan føre til en midlertidig blinding.

Unngå å inn i laserstrålen og å rette den unødig mot andre personer.

Ikke pek mot andre personer.

Advarsel:

Ikke bruk laser apparatet i nærheten av barn. Ikke tillat at barn benytter laser-apparatet.

OBS! En reflekterende overflate kan sende laserstrålen tilbake til bruker eller reflektere andre personen.

Hold kroppsdeler i sikker avstand til deler som beveger seg.

Gjennomfør regelmessig kontrollmålinger. Spesielt før, under og etter viktige målinger.

Se opp for feilmålinger hvis det er feil ved instrumentet, hvis det har falt i bakken, hvis det har vært utsatt for ikke tillatte belastninger, eller hvis det har blitt ombygd.

Advarsel: Bruk av styreelement, innstillinger eller gjennomføring av andre fremgangsmåter enn de som er fastlagt i håndboken kan føre til farlig strålebelastning.

Lasermåleapparatet har et begrenset bruksområde. (Se avsnitt "Tekniske data"). Forsøk på måling utenfor det minimale og maksimale område forårsaker unøyaktigheter. Bruk ved vanskelige betingelser som for varmt, for kaldt, svært sterkt sollys, regn, snø, tåke eller andre betingelser som innskrenker sikten, kan føre til unøyaktige målinger.

Dersom lasermåleapparatet blir brakt fra en varm omgivelse til en kald omgivelse (eller omvendt), må det ventes til apparatet har tilpasset seg den nye omgivelsestemperaturen.

Lasermåleapparatet skal alltid oppbevares i rom som beskytter apparatet mot rystelse, vibrasjoner og ekstreme temperaturer.

Lasermåleapparatet skal beskyttes mot støv, væte og høy luftfuktighet. Dette kan skade de indre delene og ha innflytelse på nøyaktigheten.

Ikke bruk aggressive rensmiddel eller løsemiddel. Skal rengjøres bare med en ren myk klut.

Unngå harde slag på og fall av lasermåleapparatet. Nøyaktigheten av apparatet burde kontrolleres dersom det har falt ned eller har vært utsatt for andre mekaniske belastninger.

Nødvendige reparasjoner på dette laser-apparatet skal kun gjøres av autorisert fagpersonale.

Ikke bruk instrumentet i eksplosjonsfarlige områder eller i aggressive miljøer.

Batteriene må bare lades opp med et ladeapparat som er levert av produsenten.

 Elektrisk og elektronisk avfall skal ikke avfallshåndteres sammen med husholdningsavfallet. Brukte batterier, elektrisk og elektronisk avfall skal samles kildesortert og avfallshåndteres.

Fjern brukte batterier, akkumulatører og lysmidler fra apparatene før de kasseres.

Be om informasjon hos de lokale myndighetene eller hos din fagforhandler om miljøstasjoner og samlesteder.

Avhengig av de lokale bestemmelsene kan detaljhandlere være forpliktet til å ta tilbake brukte batterier, elektrisk og elektronisk avfall uten kostnader.

Bidra til å redusere behovet for råmaterialer ved å sørge for gjenbruk og resirkulering av dine brukte batterier og ditt elektriske og elektroniske avfall.

Brukte batterier (særlig litium-ion-batterier), elektrisk og elektronisk avfall inneholder verdifulle, gjenbrukbare materialer som ved ikke-miljøriktig avfallshåndtering kan ha negative konsekvenser for miljøet og din helse.

Slett først eventuelle personrelaterede data fra det brukte apparatet før det avfallshåndteres.

 Europeisk samsvarsmerke

 Britisk samsvarsmerke

 Ukrainsk samsvarsmerke

 Euroasiatisk samsvarsmerke

TEKNISKE DATA

Verneklasse	IP54 (støv- og sprutevann beskyttet)
Optik	14 mm
Fokus	35 mm
Måleområde maks	50 meter (toleranse: 55m)
Måleområde minimum.	0,05 meter
Absolutt nøyaktighet @ < 10m	± 1,5 mm (maks)
Gjentakelse nøyaktighet @ < 10m	± 1,5 mm (typisk maks 2σ)
Gjentakelse nøyaktighet @ > 10m	Stigning ± 0,25 mm / meter (typisk maks 2σ)
Måletid	0,5 s
Display type	LCD (22,7 mm x 31 mm)
Strømforsyning	AAA 2x (Alkaline-batteri)
Batteriets levetid	10000 (Enkeltmåling)
Laser utgangsyttelse	0,6 mW ~ 0,95 mW (Class 2, 650nm)
Laserpunktstørrelse	25 x 30 mm @ 16 m (Maks)
Laser klasse	2
Laser type	650 nm, < 1 mW
Laserstråle vertikalvinkel	+1 grad
Laserstråle horisontalvinkel	±1 grad
Automatisk avslåing av apparatet	180 sekund
Automatisk avslåing av laser	30 sekund
Arbeidstemperaturområde	-10°C til +50°C
Lagertemperaturområdes	-25°C til +70°C
Vekt uten batteri	80 g

FORMÅLSMESSIG BRUK

Lasermåleapparatet er egnet for måling av avstander og hellinger.
Dette apparatet må kun brukes til de oppgitte formål.

FEILKODE TABELL

Kode	Beskrivelse	Løsning
Err01	Utenfor måleområdet	Gjennomfør målinger i planlagt område.
Err02	Reflektert signal er for svakt	Velg en bedre overflate.
Err03	Utenfor visningsområde (maks verdi: 99.999) f.eks. Er resultat av flate eller volum utenfor visningsområde	Kontroller om verdiene og trinnene er korrekt.
Err04	Feil i Pythagorasberegningen	Kontroller om verdiene og trinnene er korrekt.
Err05	Batteri er svakt	Sett inn nye batterier
Err06	Utenfor arbeidstemperaturområde	Foreta målinger i fastsatt arbeidstemperaturområde.
Err07	Lyset i omgivelsen er for sterkt	Skyggelegg måleområdet

Pythagoras
Høydeforskjell

Måle nivå

Lengdemåling

Minimum / Maksimum for kontinuerlig måling

Addisjon / Subtraksjon

PÅ / MÅLING

- ▶ På
- ▶ Måling
- ▶ Kontinuerlig måling (trykk i 2 sekund)
Minimum / Maks funksjon

ADDISJON / SUBTRAKSJON

- ▶ Addere verdi
- ▶ Navigere i minne

OVERFLATE / VOLUM

- ▶ Overflate (trykk 1x)
- ▶ Volum (trykk 2x)
- ▶ Indirekte overflatemåling (trykk 3x / 4x)

SLÅ PÅ

- ▶ På
- ▶ Av (trykk i 2 sekund)
- ▶ Tilbakesette

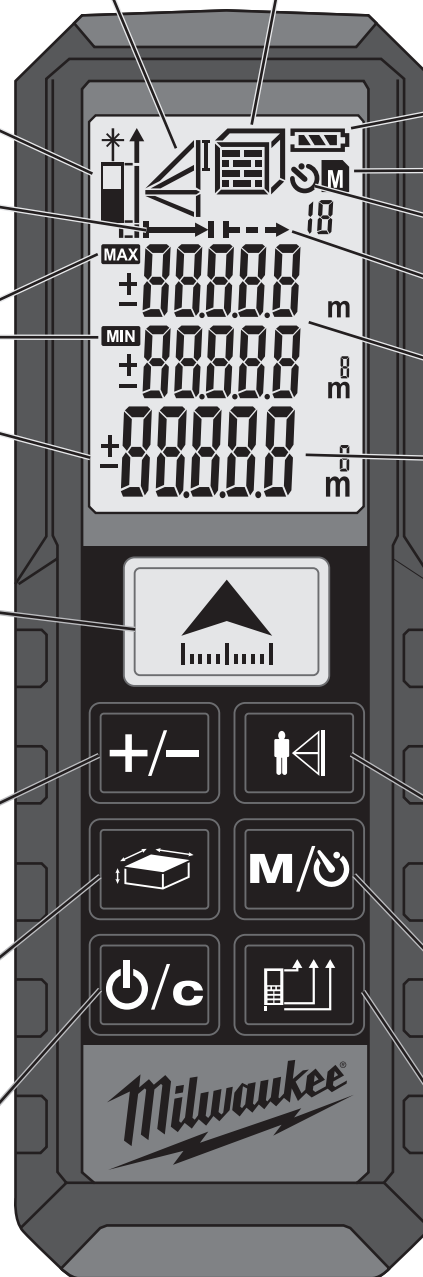

Flate / volum
Indirekt overflatemåling

Batteristatus

Minne

Tidsinnstiller

Kontinuerlig måling

Mellomverdier

Total verdi

PYTHAGORAS

- ▶ Pythagoras 1 (trykk 1x)
- ▶ Pythagoras 2 (trykk 2x)
- ▶ Pythagoras 3 (trykk 3x)

MINNE

- ▶ Tidsinnstiller 3-15 sek (trykk 1x)
- ▶ Minne 1-20 (trykk 1x 2 sekund)
- ▶ Åpne lagrede verdier (gjenta trykking)

SKIFT MÅLE NIVÅ

- ▶ Foran
- ▶ Bak
- ▶ Hjørnestift

SKIFTE BATTERI

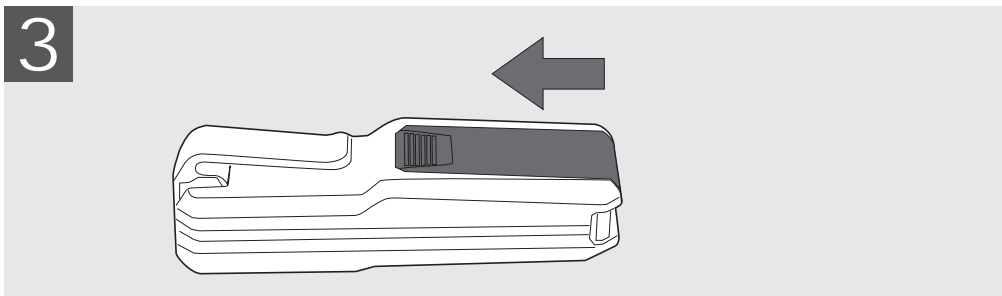
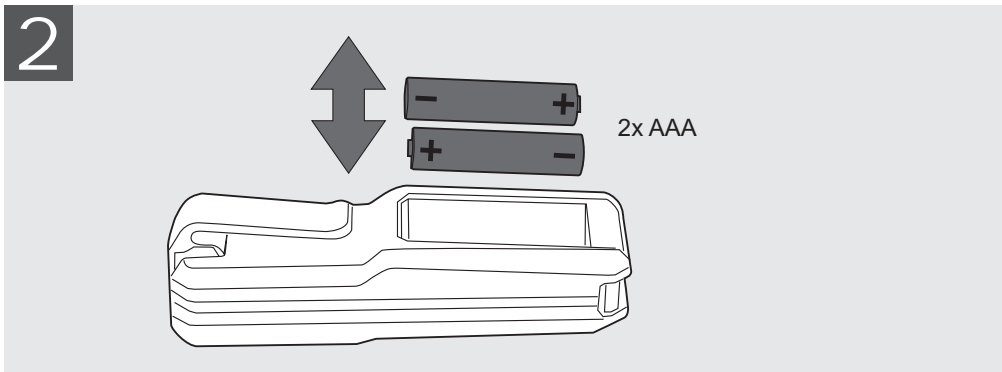
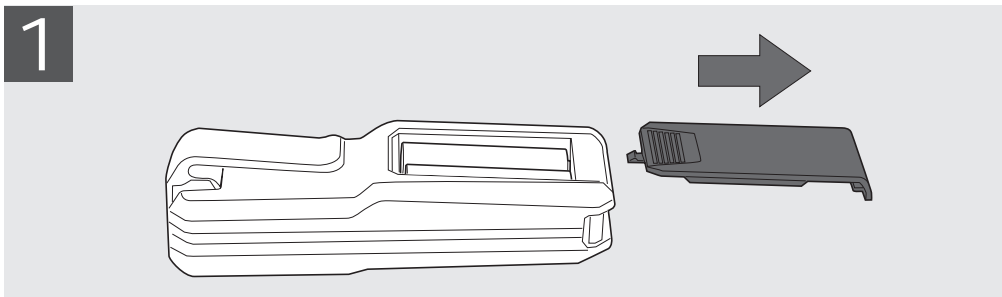
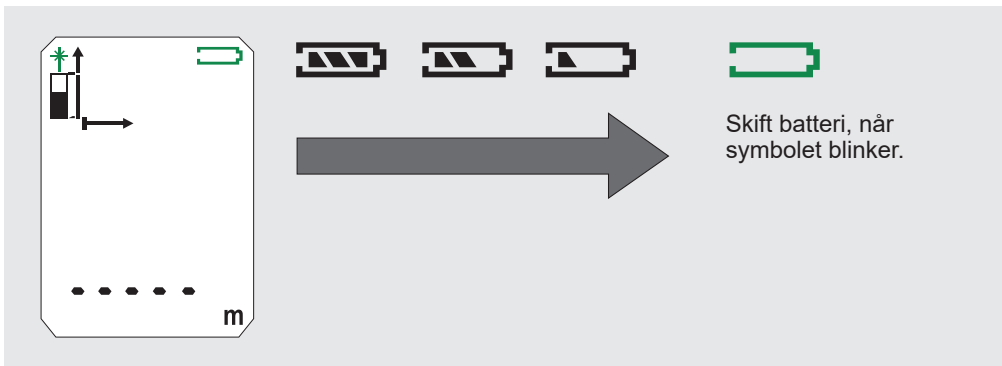

HJØRNESTIFT

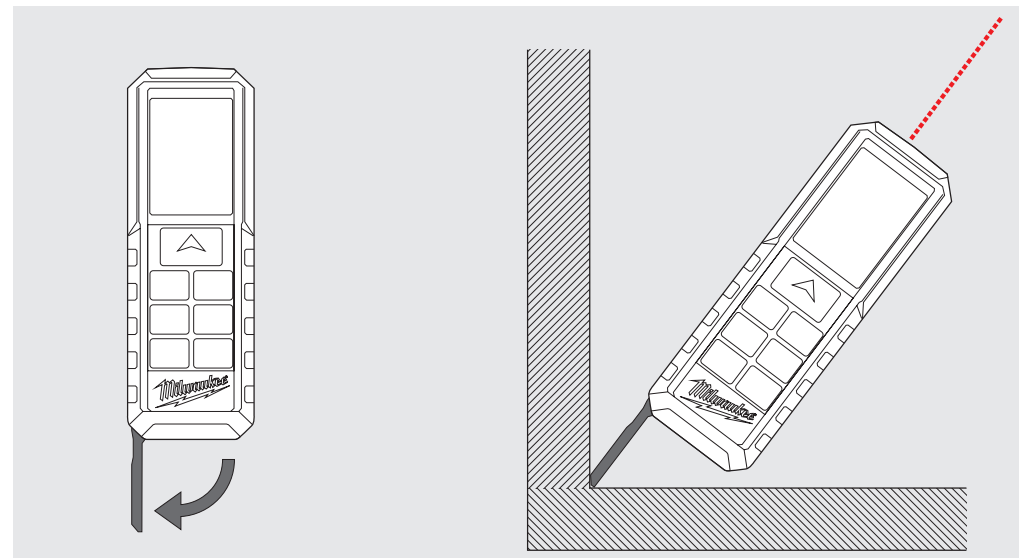

BELTEHOLDER

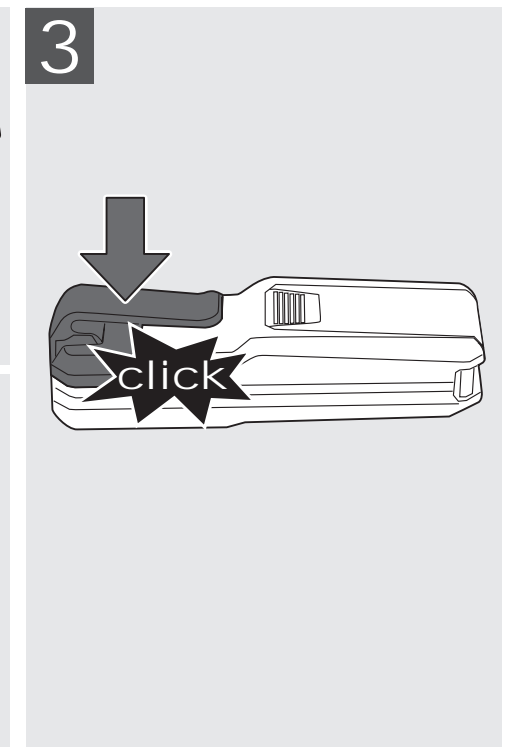
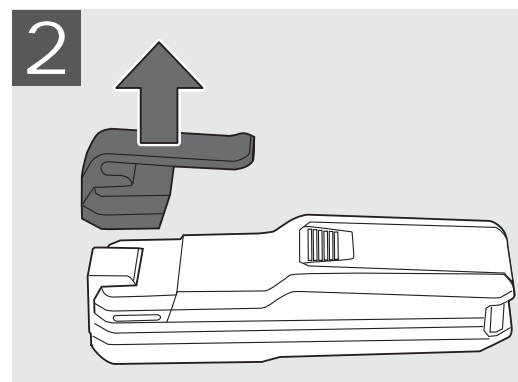
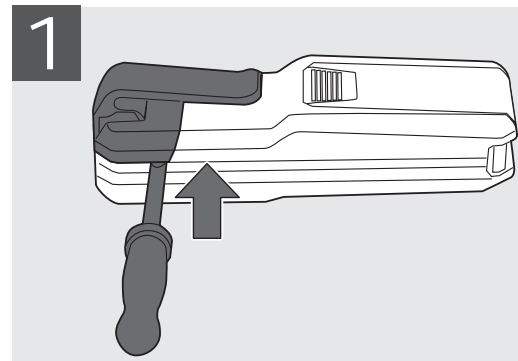

FUNKSJONSTAST, PYTHAGORAS, MÅLE NIVÅ

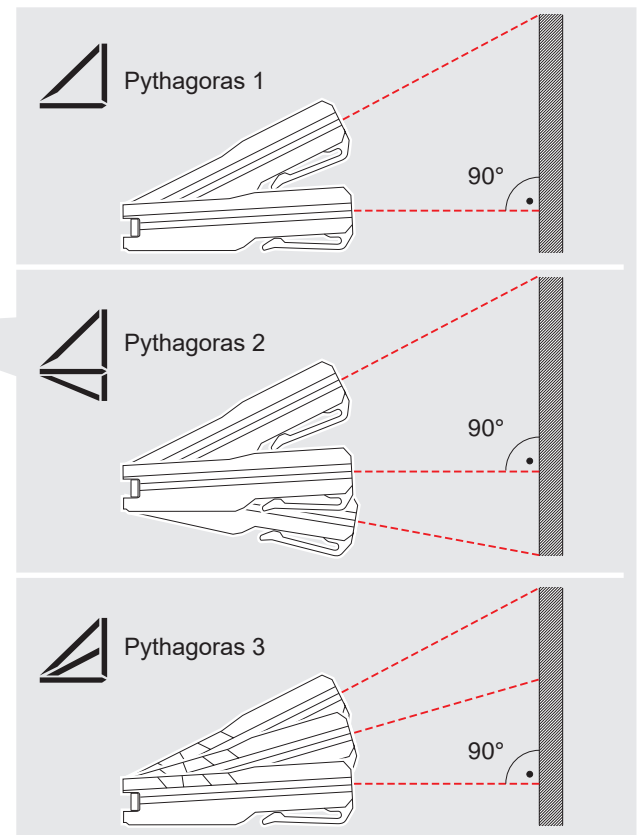
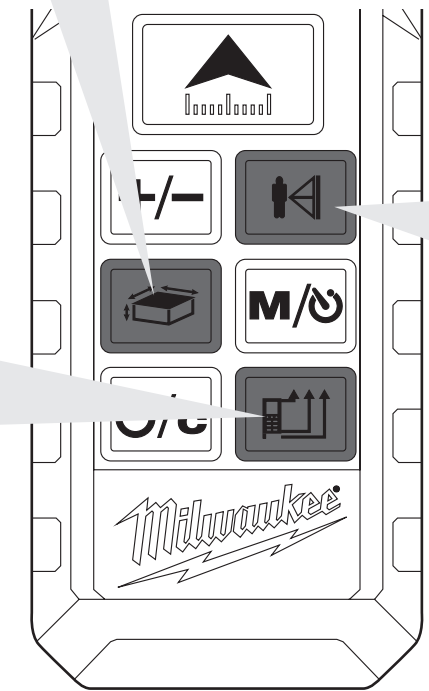
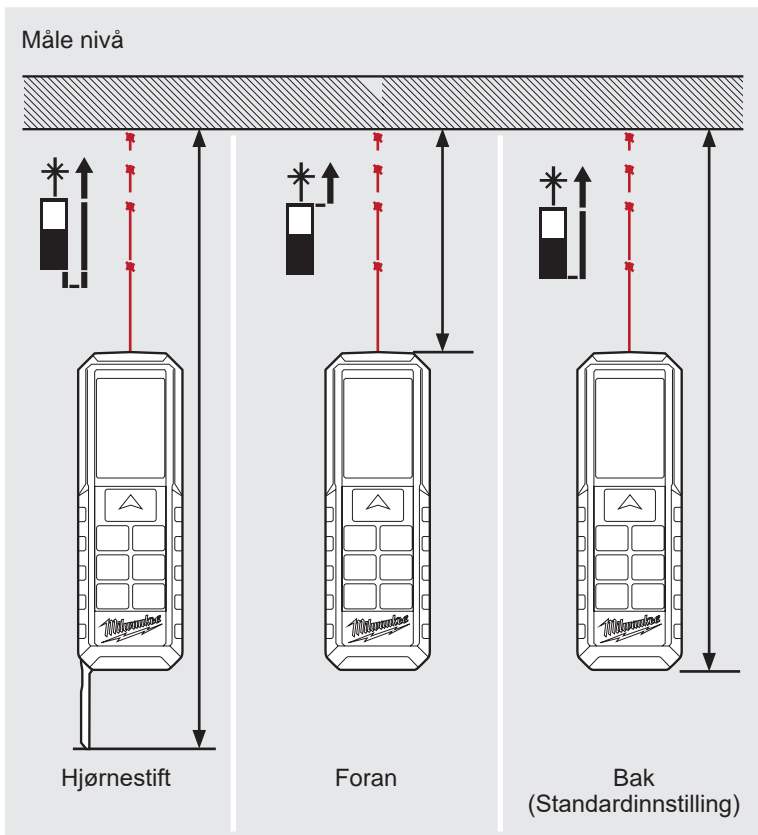
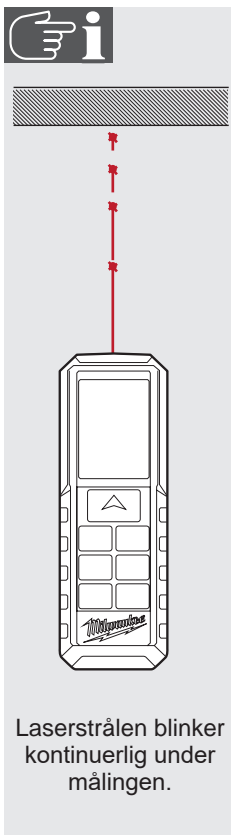
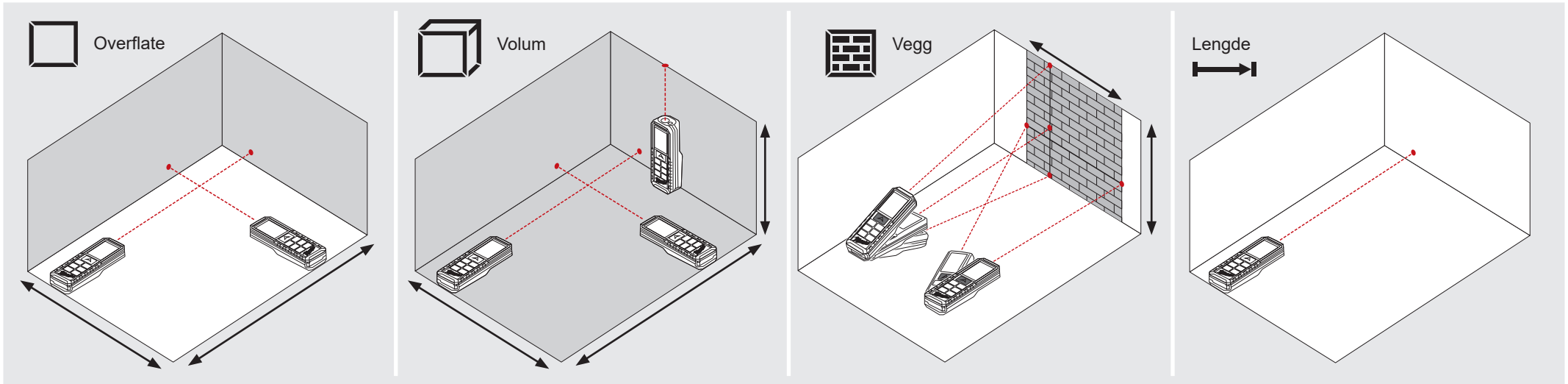

ENKEL LENGDEMÅLING

0

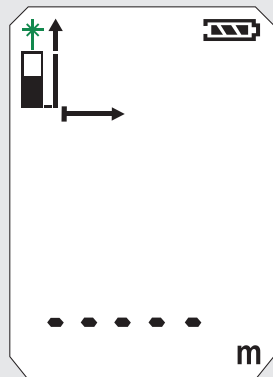

1

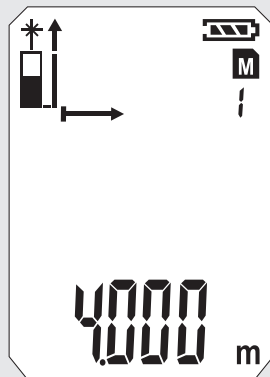

2

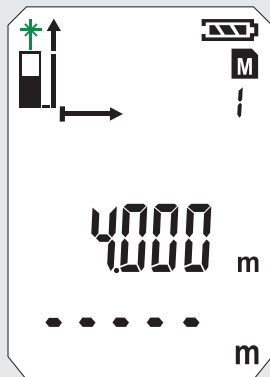

3

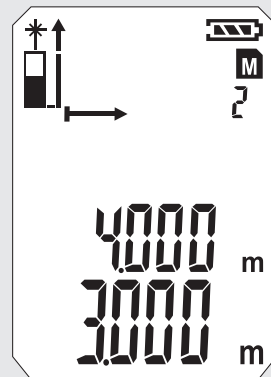

4

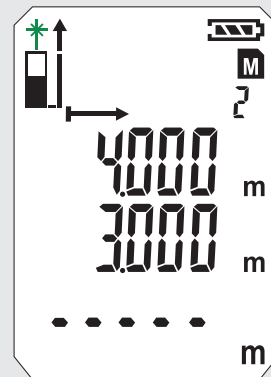

5

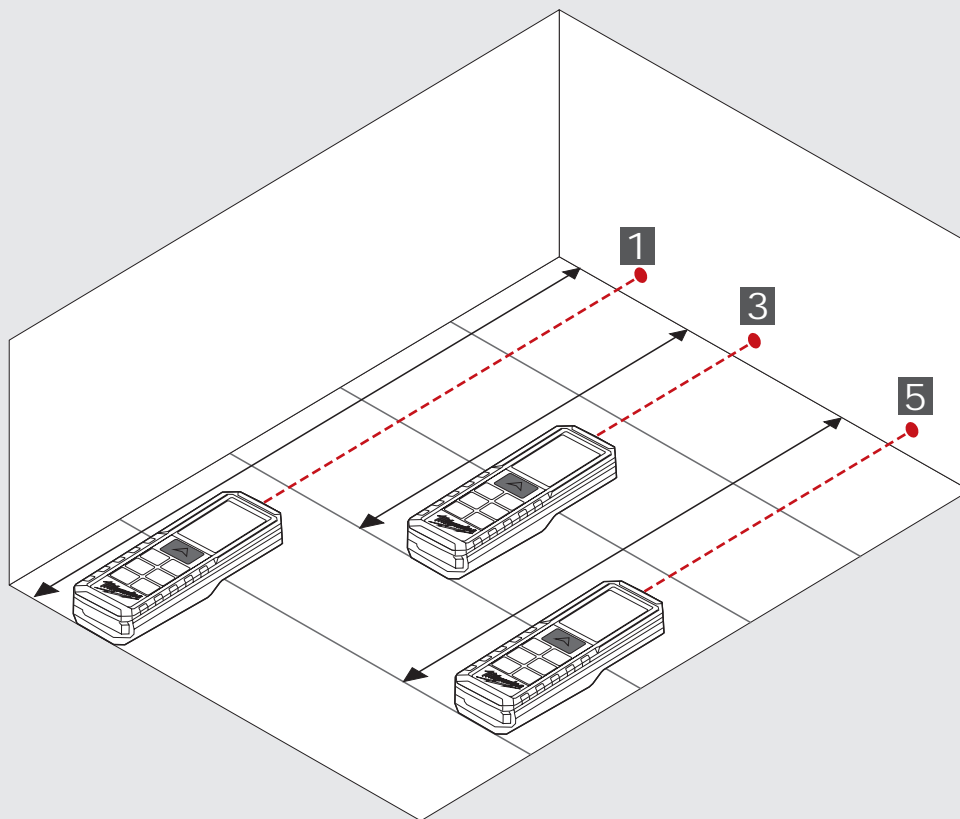
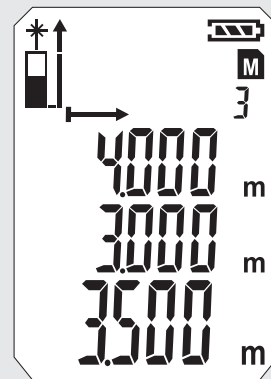

KONTINUERLIG MÅLING / MINIMUM-MAKSIMUM MÅLING

0

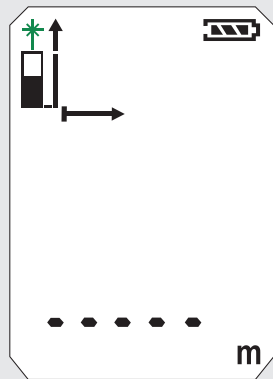

1

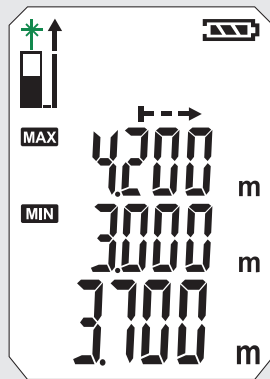

2

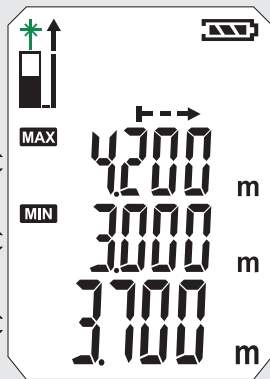

3



Stop
MIN / MAX

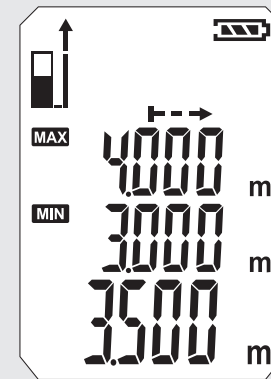

4

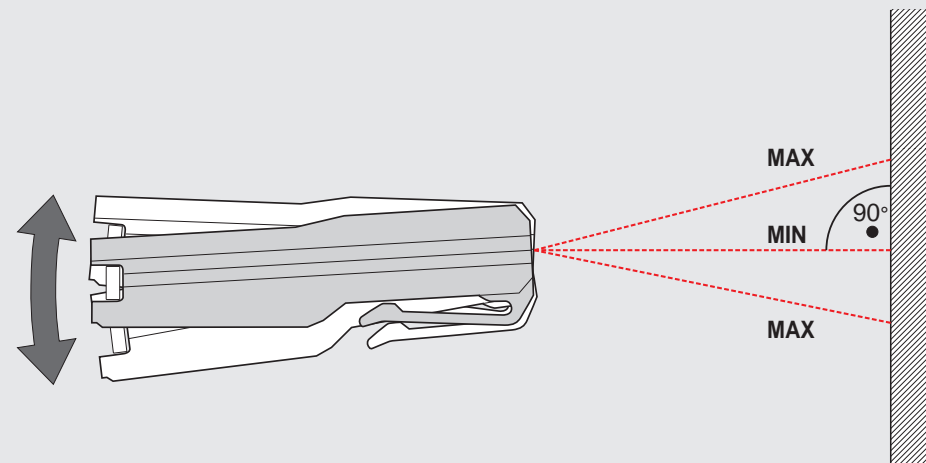
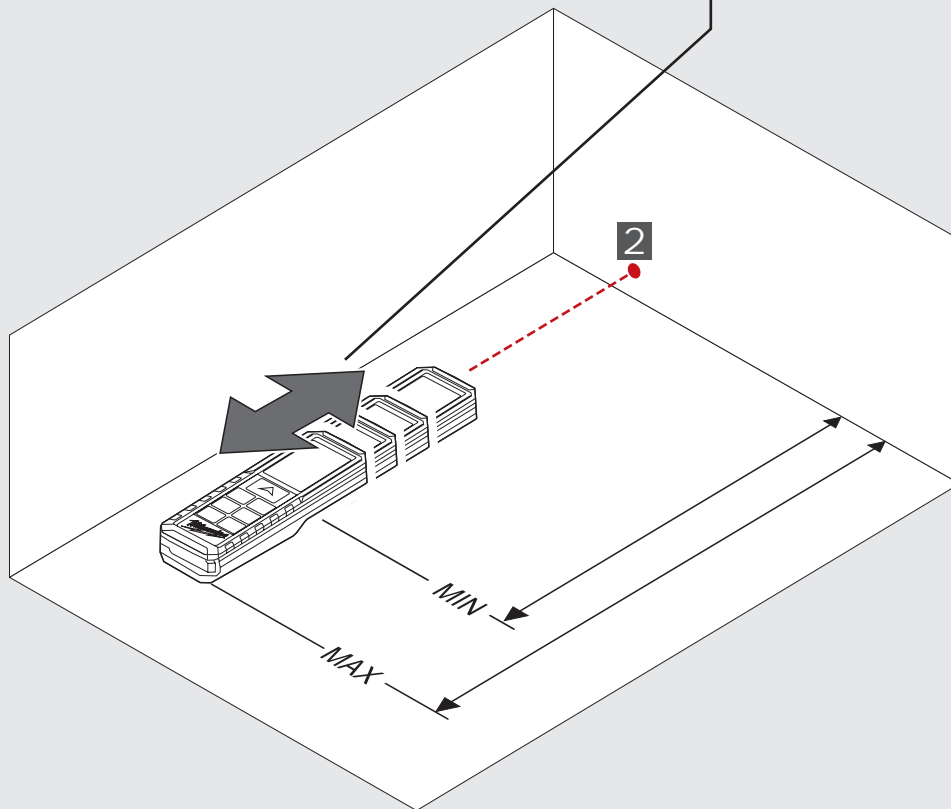
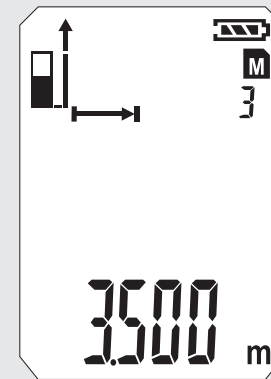

0

1

2

3

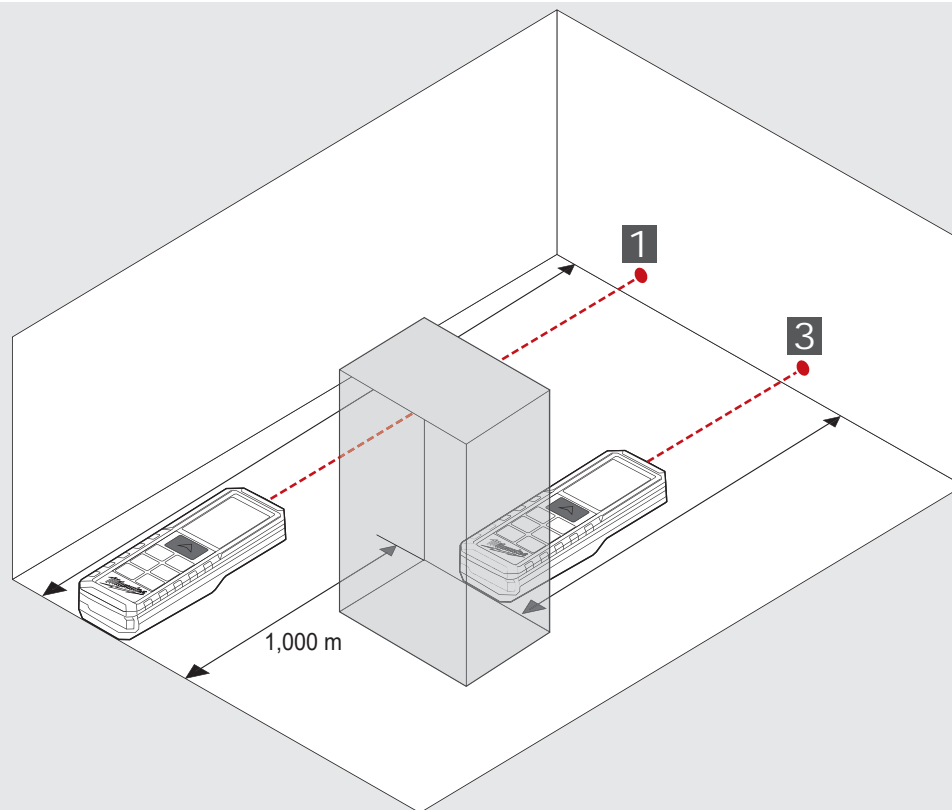
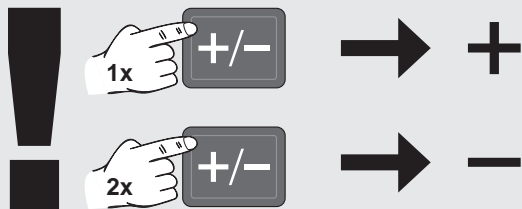
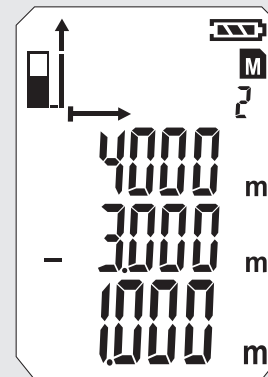
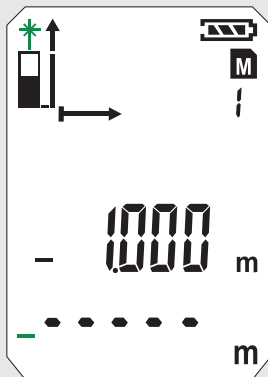
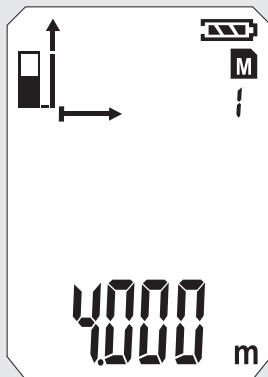
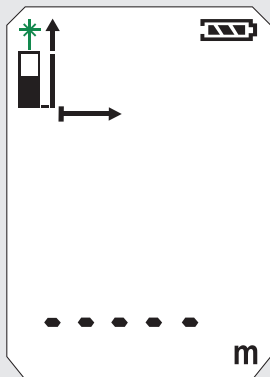

OVERFLATEMÅLING

0



1



2

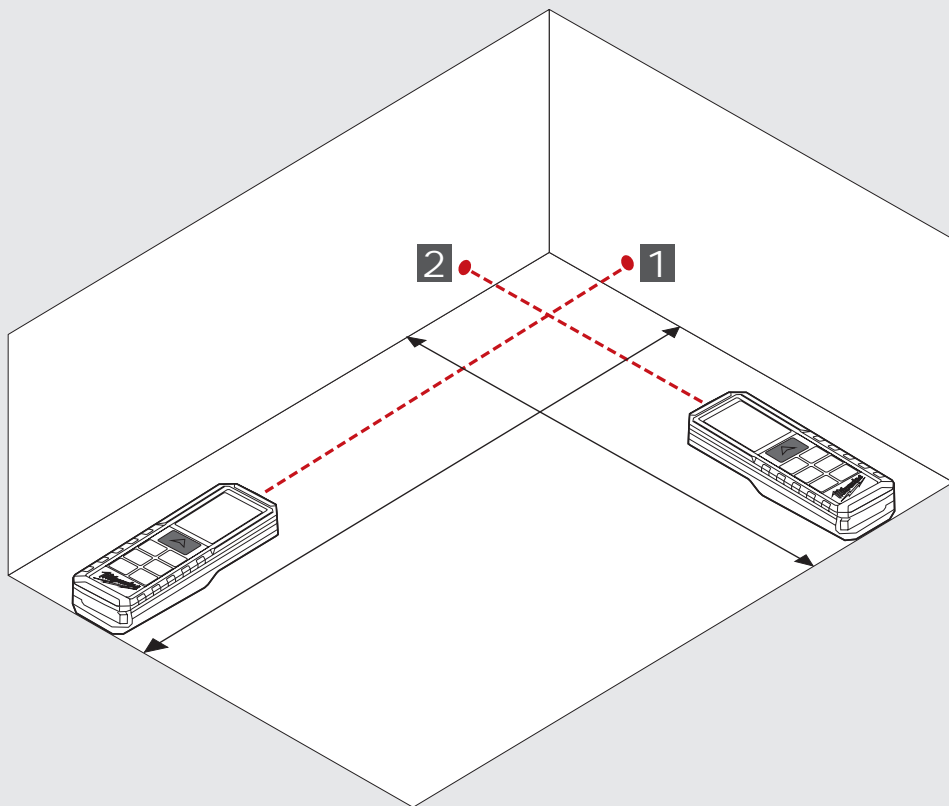
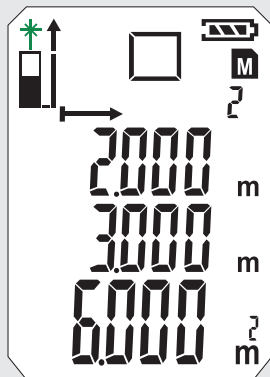
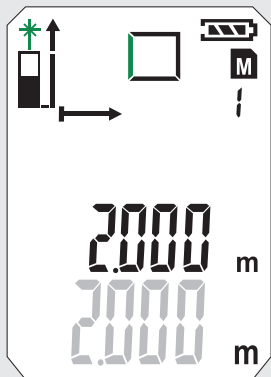
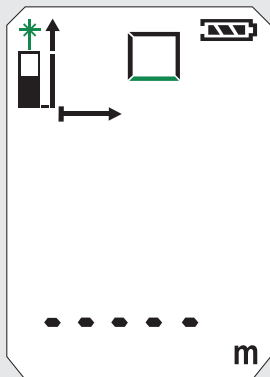

VOLUMMÅLING

0

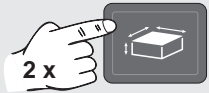

1



2



3

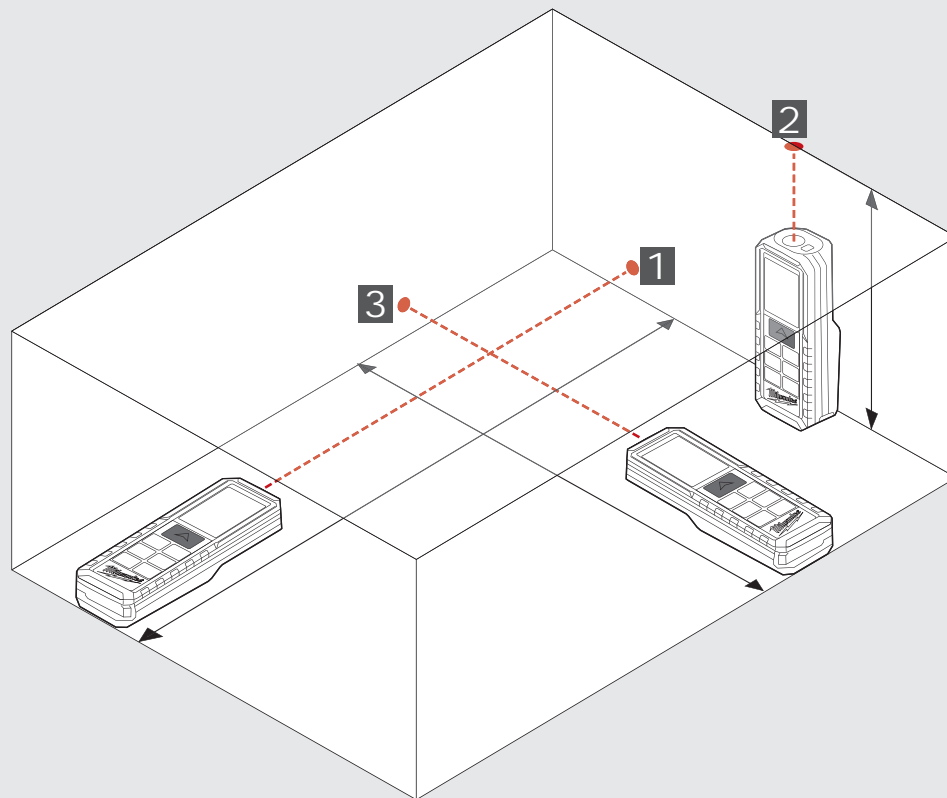
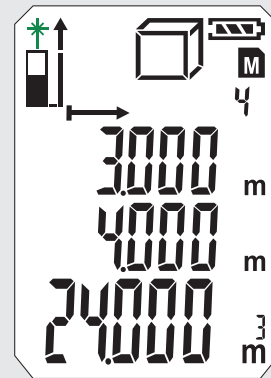
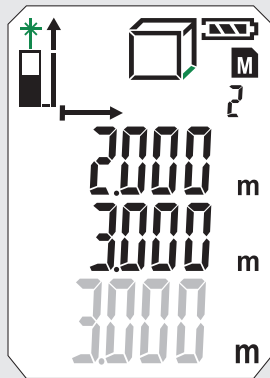
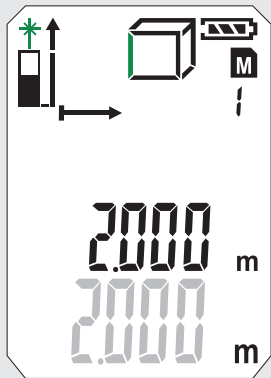
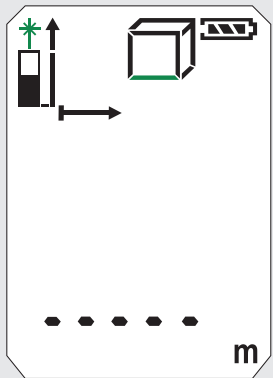
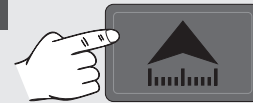

INDIREKTE MÅLING (PYTHAGORAS 1)

0



1



2

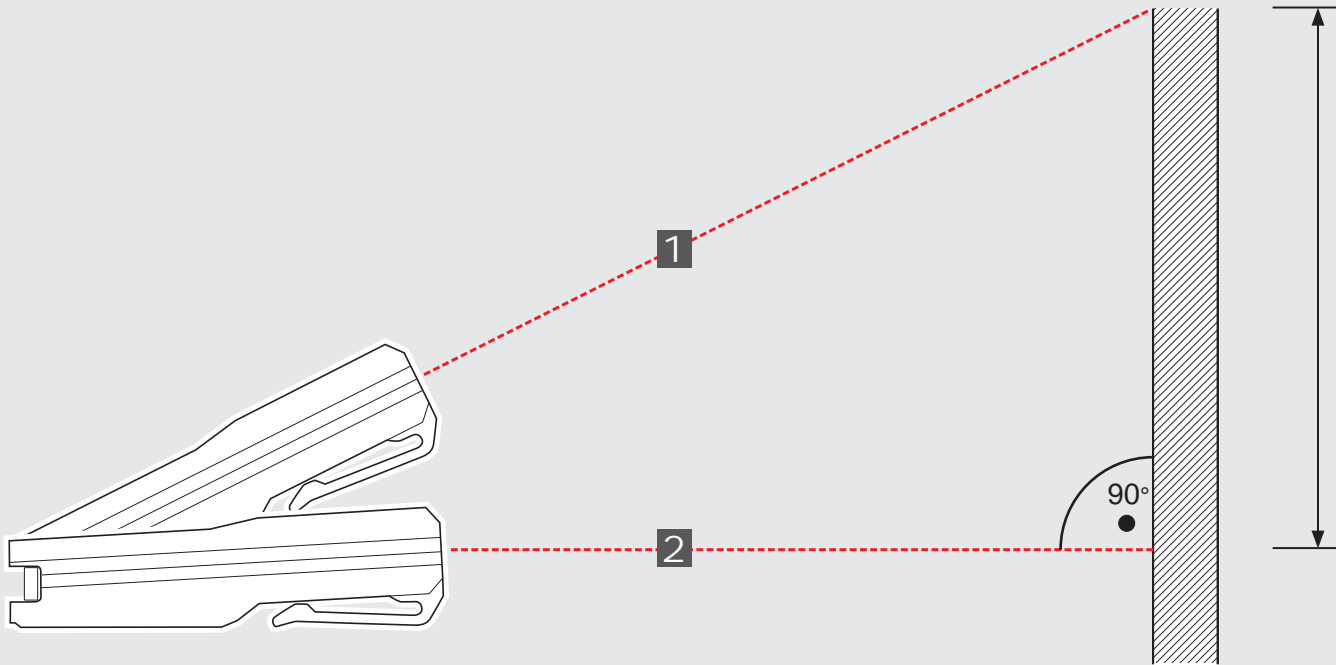
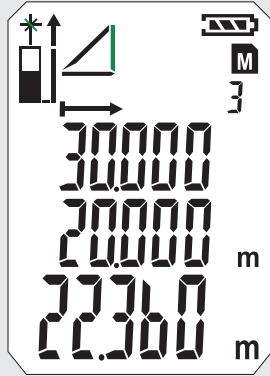
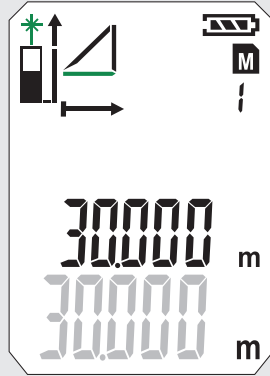
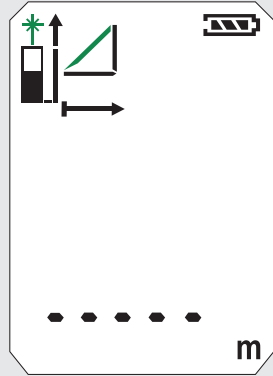

INDIREKTE MÅLING (PYTHAGORAS 2)

0



2 x

1







2

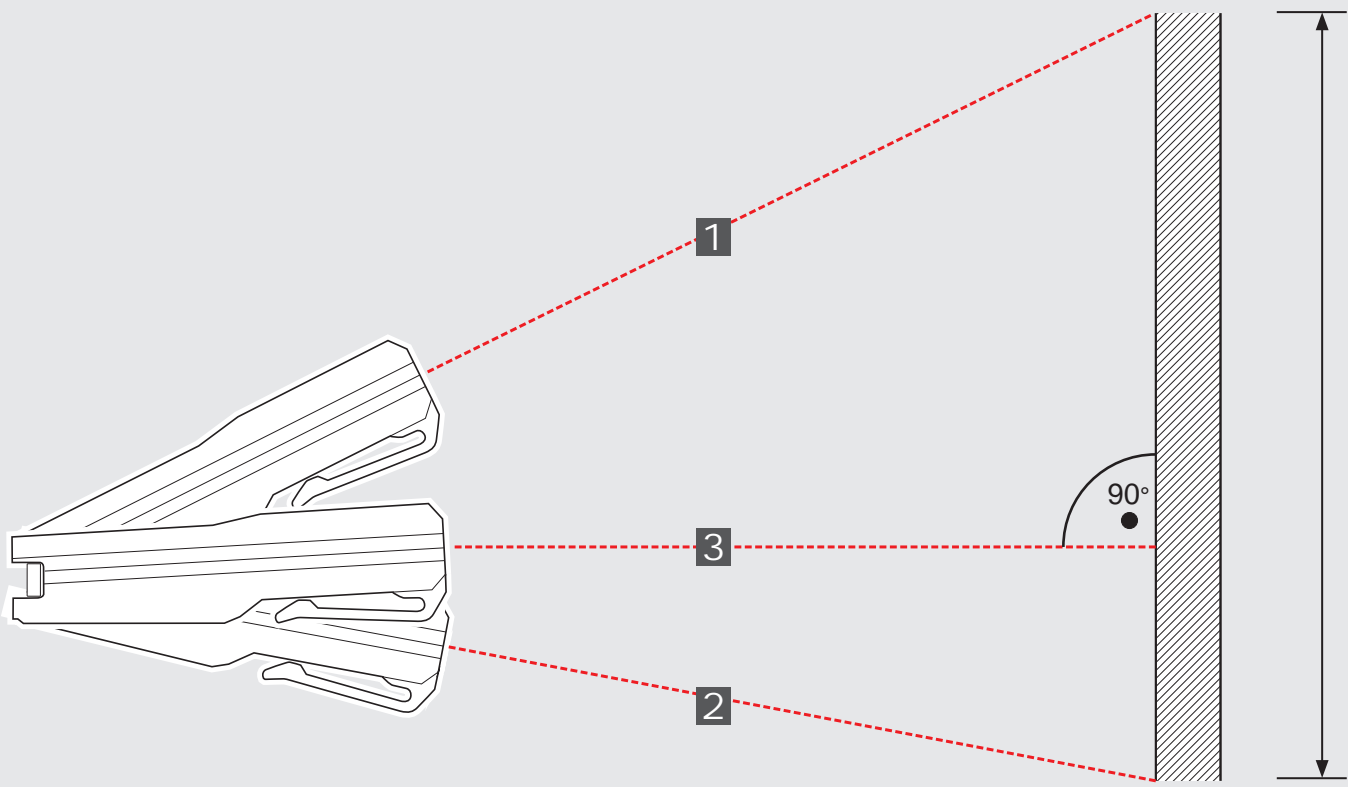
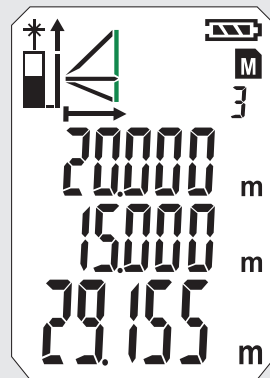
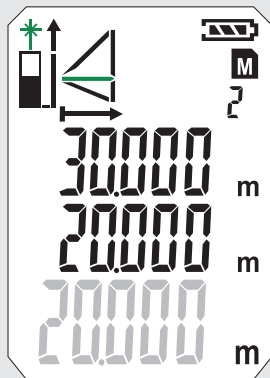
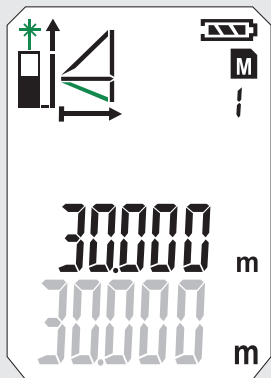
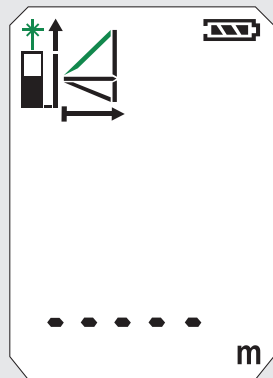

3

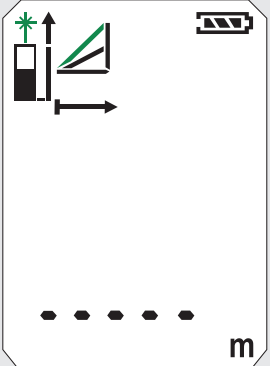
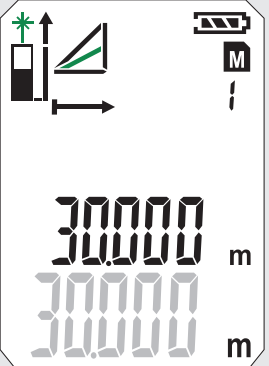
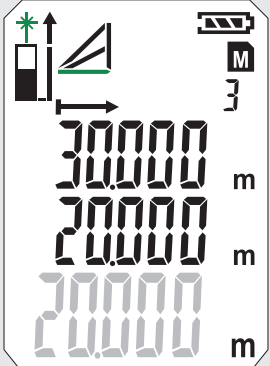
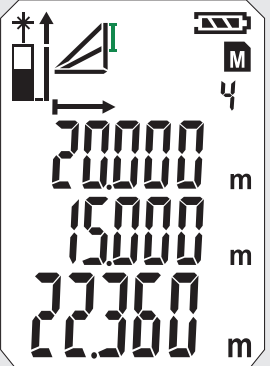

INDIREKTE MÅLING (PYTHAGORAS 3)

<p>1</p> 	<p>2</p> 	<p>3</p> 	<p>4</p> 
			

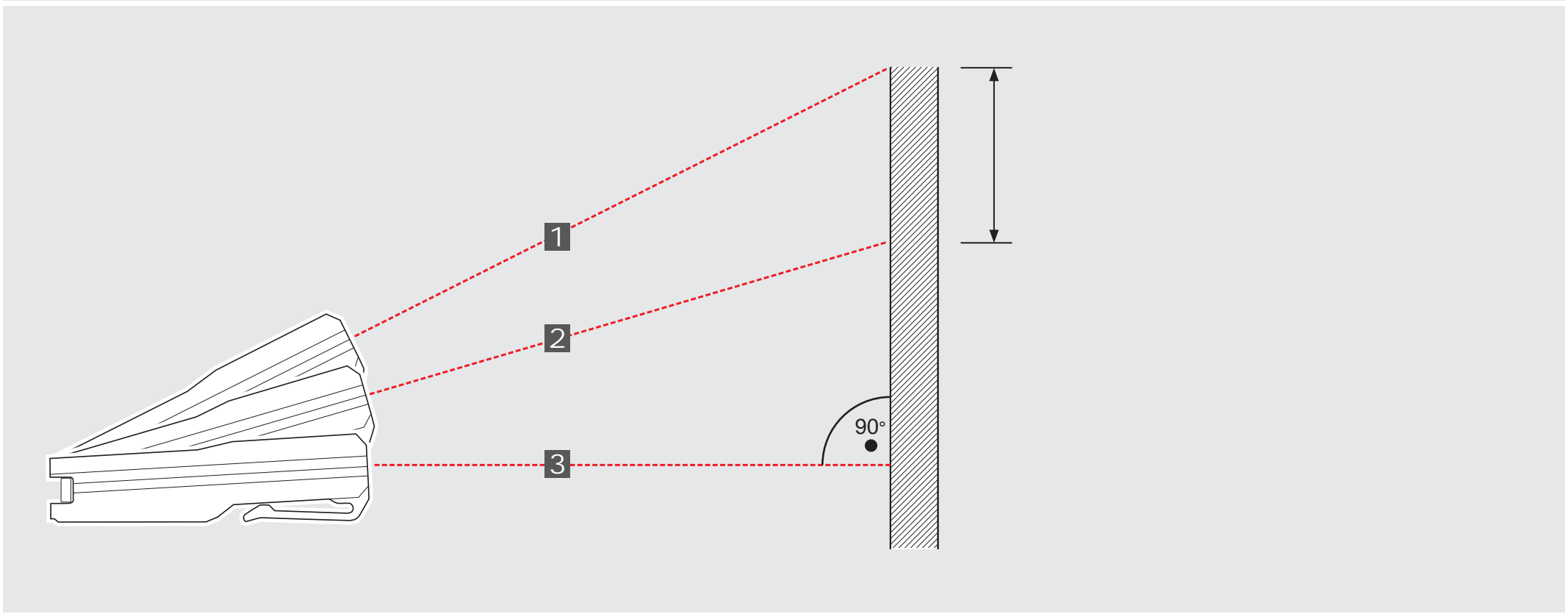





VEGGFLATE MÅLING (SCENARIO 1)

<p>0</p>	<p>1</p>	<p>2</p>	<p>3</p>	<p>4</p>

5

VEGGFLATE MÅLING (SCENARIO 2)

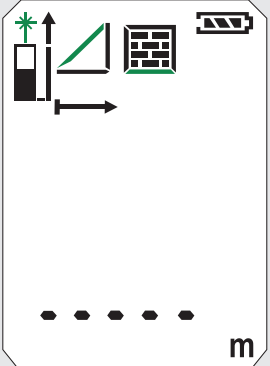
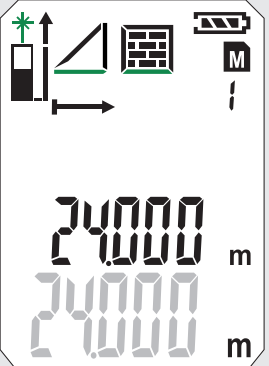
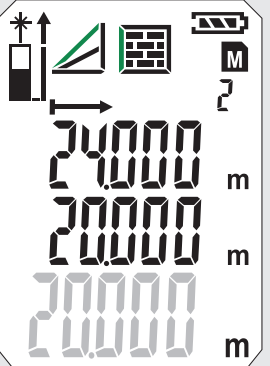
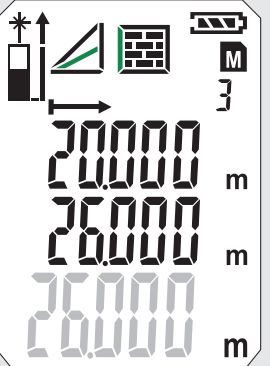
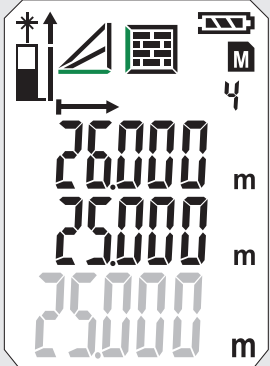
<p>0</p> 	<p>1</p> 	<p>2</p> 	<p>3</p> 	<p>4</p> 
				

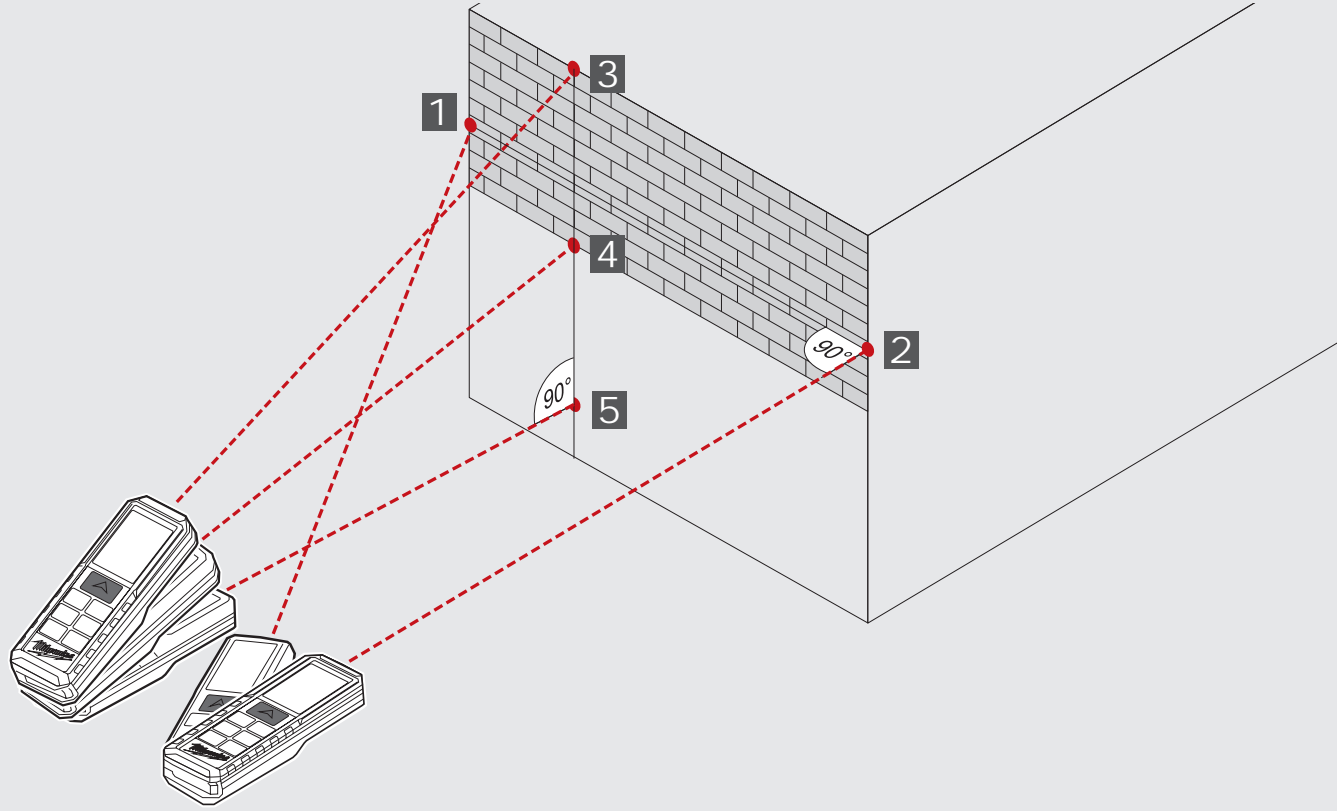

5



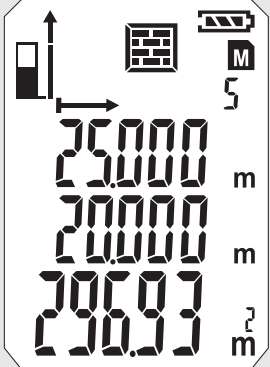



TIDSINNSTILLER

Med tidsinnstilleren kan målingen utløses forsinket, for f.eks. å posisjonere et byggeelement i målestrålen.

Trykk tast 

- Symbolet vises i displayet
- Ved å trykke tast  kan tidsinnstilleren innstilles mellom 3 og 15 sekund.

Trykk tast 

- Sekundene telles ned til målingen starter.
- Ved 0 starter målingen.

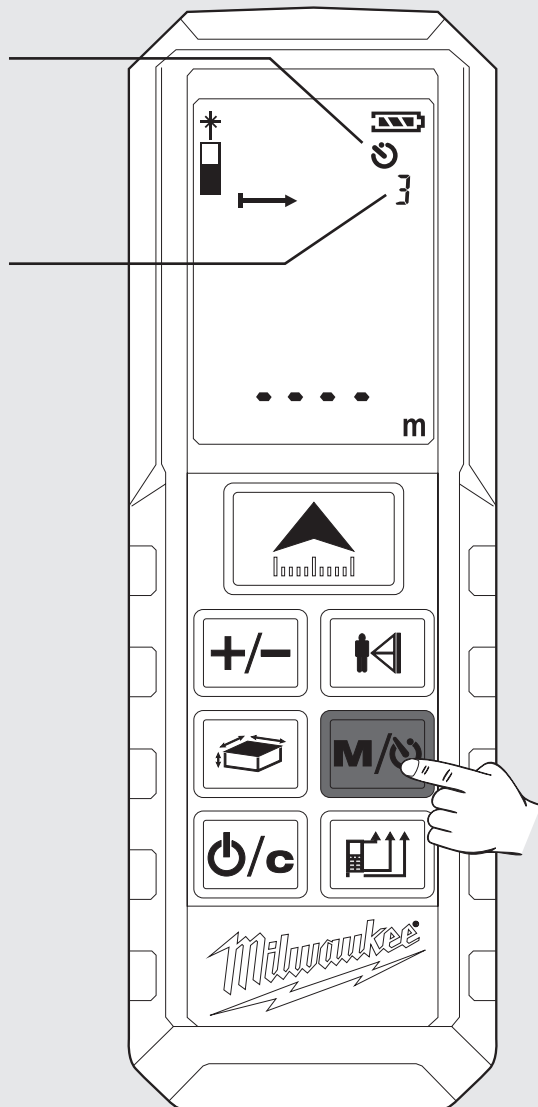

MINNE

Måleverdiene blir automatisk lagret fortløpende i minne.

De lagrede verdiene kan hentes fram ved å trykke tast .

Trykk tast  i 2 sekund

- Symbol og minneplass vises.
- Tilhørig målestørrelse blir vist.
- Lagret verdi blir vist i hovedlinjen.
- Lagrede verdier kan åpnes ved gjentatt trykking av tast .

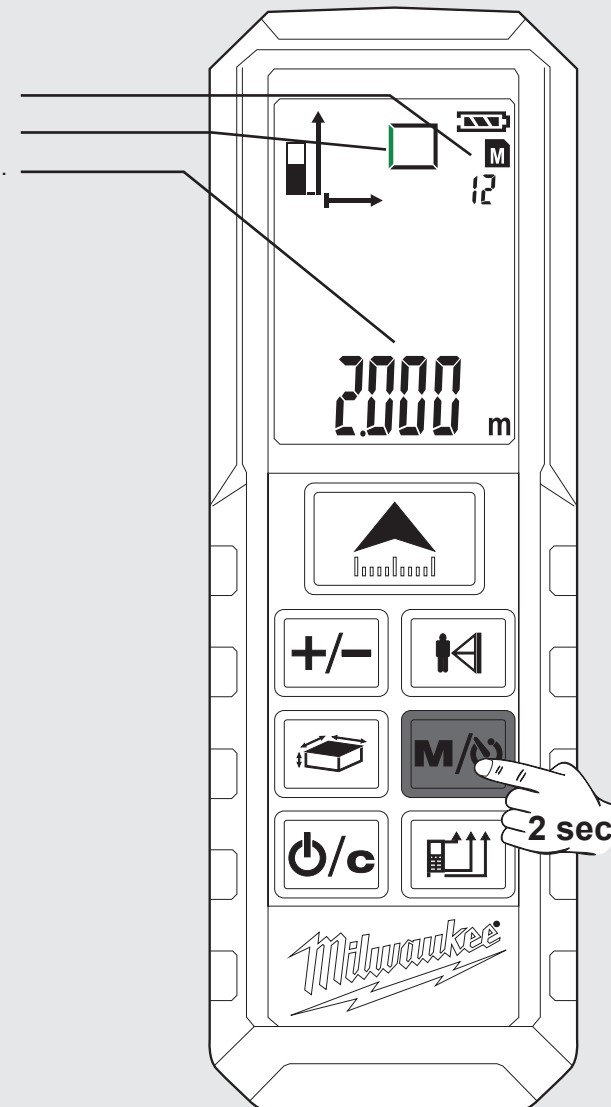

GRUNNLEGGENDE BRUKSBESKRIVELSE AV EKSEMPEL TIL EN OVERFLATEMÅLING (1)

1 Slå på

Trykk tast .
⚠ OBS! Laserstrålen er slått på!
 Ikke rett den mot personer!

Lasersymbol blinker
 (blinking blir vist i grønt).

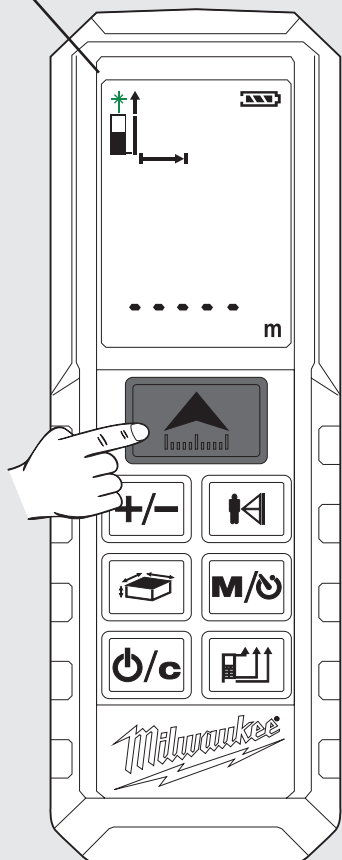

2 Velg måle nivå

Standardinnstilling etter påslåing:
 bak
 trykk 1x -> Hjørnestift
 trykk 2x -> foran
 trykk 3x -> bak

Symbol blir vist i displayet

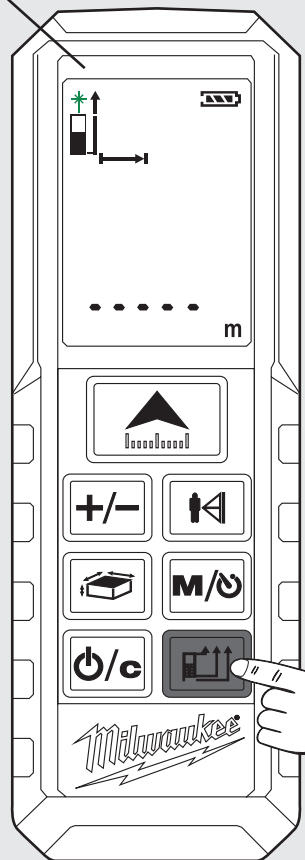

3 Velg funksjon

Når apparatet slås på, står det
 alltid på lengdemåling.
 trykk 1x - Overflatemåling

- Symbol vises
 - Målestørrelsen blinker
 (blinking blir vist i grønt)

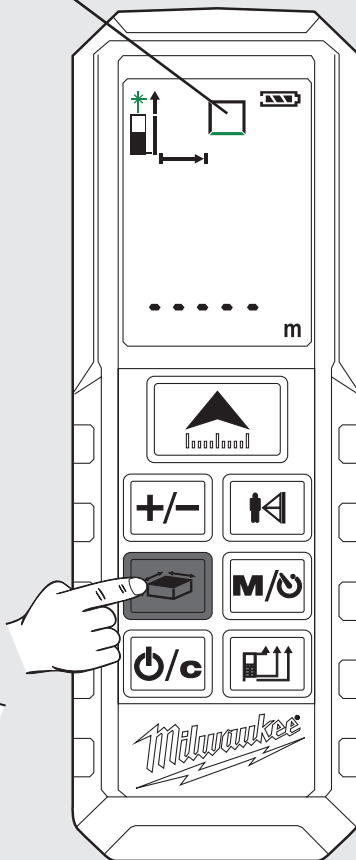

4 Lengde måling

Innstill apparatet
 og trykk
 tast 

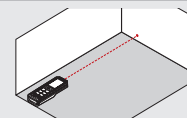

- Måleverdien vises kort i
 hovedlinjen.
 - Måleverdien hopper etter 1
 sekund i linjen over.
 Måleverdien lagres i minne etter
 fortløpende nummer.
 Målestørrelse nummer to blinker
 Apparatet er klart for måling av
 verdi nummer to.

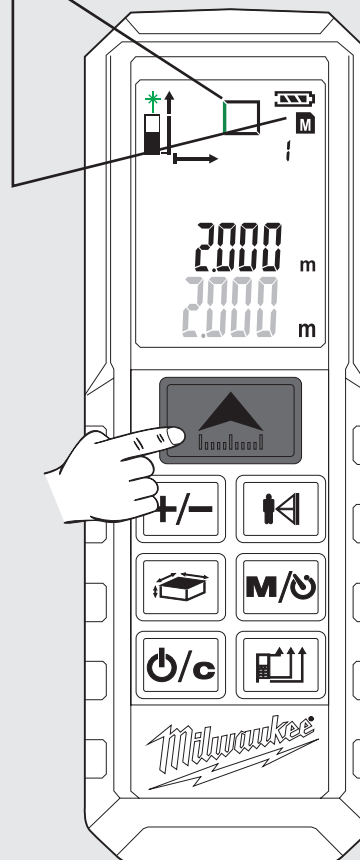

5 Måle bredde

Innstill apparatet
 og trykk 

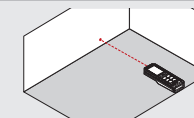

- Måleverdien vises kort i
 hovedlinjen.
 - Måleverdien hopper etter 1 sekund
 i linjen over.
 Måleverdien lagres i minne etter
 fortløpende nummer.
 - Resultat blir vist i hovedlinjen og
 lagres i minne etter fortløpende
 nummer.

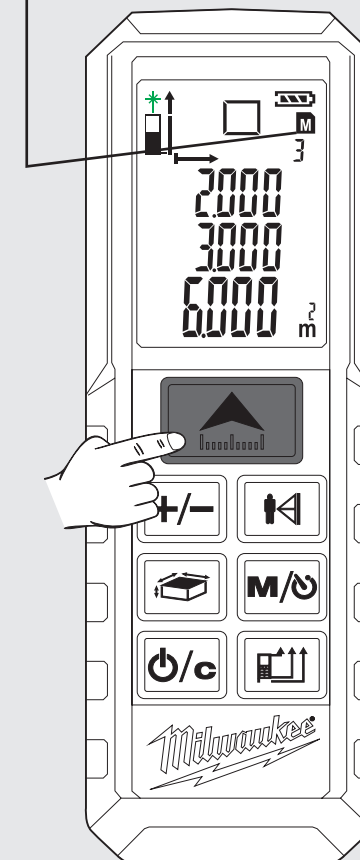

GRUNNLEGGENDE BRUKSBESKRIVELSE AV EKSEMPEL TIL EN OVERFLATEMÅLING (2)

6 Hente fram lagret verdi

Trykk tast **M/0** i 2 sekund.

Trykk knappen **M/0** flere ganger.

7 Forlat minne

Trykk tast **0/c**

8 Slå av

Trykk tast **0/c** i 2 sekund
(Minne må forlates først).

- Lagrede verdier blir vist i hovedlinjen.

- Det symbol som hører til blir vist og målestørrelsen blinker (blinking blir vist i grønt).

- Apparatet slås av.

- Dersom i 3 minutt ingen tast blir trykket, slås apparatet automatisk av.

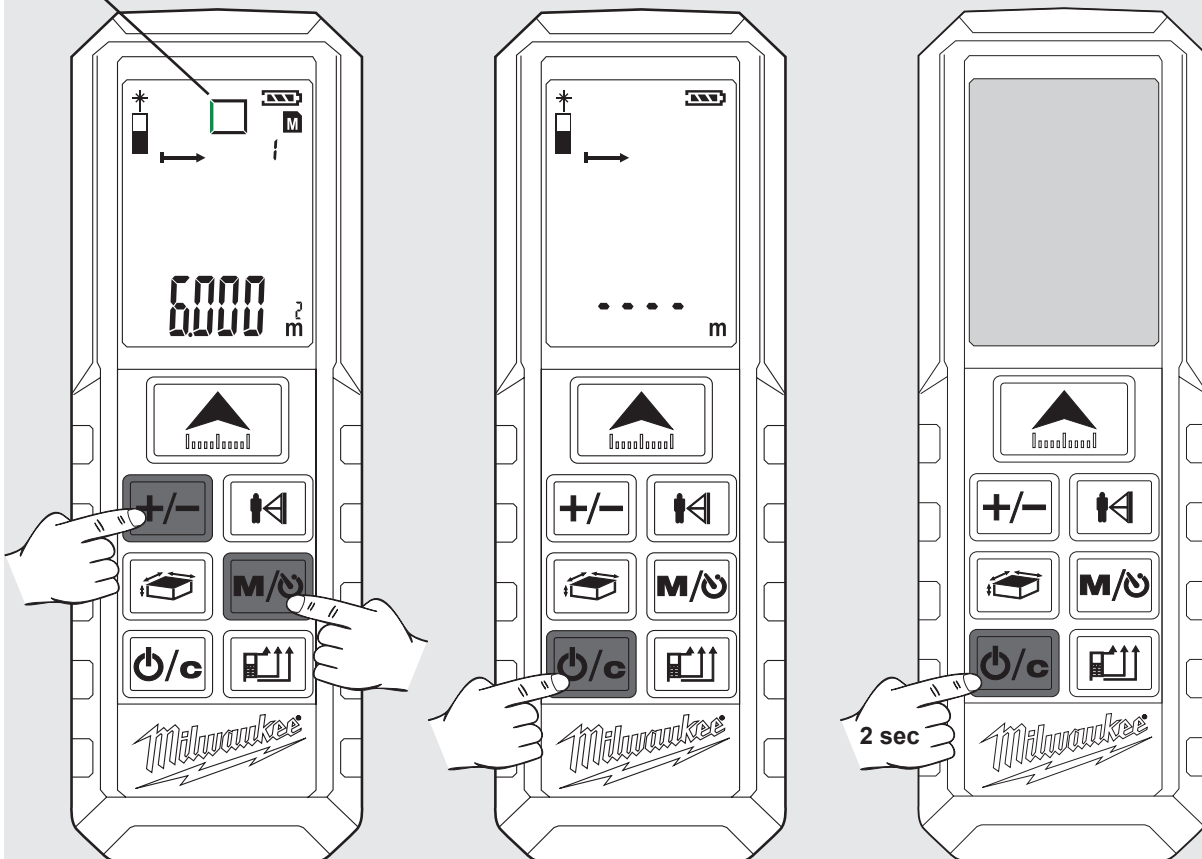

INNEHÅLL

Viktiga säkerhetsföreskrifter	1
Tekniska data.....	2
Använd maskinen enligt anvisningarna	2
Tabell med felkoder	2
Översikt	3
Byte av batteri.....	4
Hörnpinne	4
Bälteshållare.....	4
Funktionsknapp, Pythagoras, mätnivå	5
Enkel längdmätning.....	6
Kontinuerlig mätning/minimum-maximum mätning.....	7
Additions- / Subtraktionsmässung.....	8
Areamätning	9
Volymmätning	10
Indirekt mätning (Pythagoras 1)	11
Indirekt mätning (Pythagoras 2)	12
Indirekt mätning (Pythagoras 3)	13
Mätning väggarea (Scenario 1)	14
Mätning väggarea (Scenario 2)	15
Timer	16
Minne.....	16
Grundläggande funktionssätt beskrivet med en areamätning som exempel (1).....	17
Grundläggande funktionssätt beskrivet med en areamätning som exempel (2).....	18

VIKTIGA SÄKERHETSFÖRESKRIFTER



Använd inte denna produkt utan att läsa säkerhetsföreskrifter och handbok på bifogad CD.

Laserklassificering

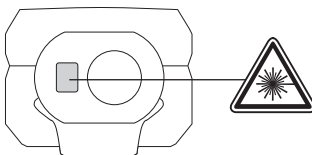

VARNING:

Produkten motsvarar klass 2 enligt: EN60825-1:2014.



λ 650 nm P<1 mW

Varning:

Undvik direkt blickkontakt: Laserstrålen kan blixtra i ögonen och leda till en kortvarig bländning.

Titta inte in i laserstrålen och rikta den inte mot andra personer i onödan.

Blända inte andra personer.

Varning:

Använd laser-apparaten aldrig i närheten av barn och tillåt barn aldrig att använda laser-apparaten.

Varning! En reflekterande yta kan kasta tillbaka laserstrålen till användaren eller andra personer.

Håll fingrarna på säkert avstånd från roterande komponenter.

Utför periodiska kontrollmätningar. Särskilt före, under och efter viktiga mätningar.

Se upp för felaktiga mätningar om en defekt produkt används, efter ett fall eller andra otillåtna påfrestningar resp. förändringar av produkten.

Varning: Användning av manöverkomponenter och inställningar eller andra förfaranden resp. metoder som inte nämns i manualen kan orsaka farlig strålbekstrålning.

Lasermätinstrumentet har ett begränsat användningsområde. (Se avsnittet "Tekniska data"). Försök att göra mätningar utanför det maximala resp. det minimala området leder till bristande noggrannhet. Användning vid ogynnsamma förhållande som för kallt, för varmt, starkt solljus, regn, snö, dimma eller andra förhållanden som begränsar sikten kan leda till oprecisa mätningar.

Om lasermätinstrumentet förs från en varm omgivning till en kall omgivning (eller tvärt om), vänta tills instrumentet har anpassat sig till den nya omgivningstemperaturen.

Förvara alltid lasermätinstrumentet i utrymmen som skyddar instrumentet mot skakningar, vibrationer eller extrema temperaturer.

Skydda lasermätinstrumentet mot damm, fukt och hög luftfuktighet. Detta kan förstöra komponenter inne i instrumentet på påverka noggrannheten.

Använd inga aggressiva rengöringsmedel eller lösningsmedel. Rengör endast med en ren, fuktig trasa.

Undvik kraftiga slag mot instrumentet och låt det inte falla till marken. Instrumentets noggrannhet bör kontrolleras om det har fallit till marken eller har utsatts för andra mekaniska belastningar.

Om denna laser-apparat behöver repareras så får endast auktoriserad fackpersonal utföra reparationen.

Använd inte produkten i aggressiv eller explosiv miljö.

Använd endast batteriladdare rekommenderade av tillverkaren för att ladda batterier.



Förbrukade batterier och avfall som utgörs av eller innehåller elektrisk och elektronisk utrustning (WEEE) får inte slängas tillsammans med de vanliga hushållssoporna. Förbrukade batterier eller WEEE ska samlas och avfallshandteras separat.

Ta ut förbrukade batterier, förbrukade ackumulatörer och ljuskällor ur produkterna innan de avfallshandteras.

Kontakta den lokala myndigheten respektive kommunen eller fråga återförsäljare var det finns speciella avfallsstationer för elskrot.

Beroende på de lokala bestämmelserna kan återförsäljare vara skyldiga att ta tillbaka förbrukade batterier eller WEEE gratis.

Bidra till att minska behovet av råämnen genom återanvändning och återvinning av dina förbrukade batterier eller ditt WEEE.

Förbrukade batterier (i synnerhet litiumjonbatterier) och WEEE innehåller värdefulla återvinningsbara material som kan skada miljön och din hälsa om de inte avfallshandteras på korrekt sätt. Tänk på att radera eventuella personuppgifter som kan finnas på din utrustning innan du lämnar den till avfallshandtering.



Europeisk symbol för överensstämmelse



Brittisk symbol för överensstämmelse



Ukrainskt konformitetsmärke



Euroasiatiskt konformitetsmärke

TEKNISKA DATA

Skyddsklass	IP54 (damm- och stänkvattenskydd)
Optik	14 mm
Brännpunkt	35 mm
Mätområde max.	50 Meter (tolerans: 55 m)
Mätområde min.	0,05 meter
Absolut noggrannhet @ < 10m	± 1,5 mm (max)
Repeternoggrannhet @ < 10m	± 1,5 mm (typisk max. 2σ)
Repeternoggrannhet @ > 10m	Stigning± 0,25 mm / meter (typisk max. 2σ)
Mättid	0,5 s
Displaytyp	LCD (22,7 mm x 31 mm)
Strömförsörjning	AAA 2x (alkali-batteri)
Batteriets livstid	10000 (enskild mätning)
Laser uteffekt	0,6 mW ~ 0,95 mW (Klass 2, 650nm)
Laserpunktstorlek	25 x 30 mm @ 16 m (max)
Laserklass	2
Lasertyp	650 nm, < 1 mW
Laserstråle vertikalvinkel	+1 grad
Laserstråle horisontalvinkel	±1 grad
Automatisk apparatavstängning	180 sekunder
Automatisk laseravstängning	30 sekunder
Arbetstemperaturområde	-10°C till +50°C
Lagertemperaturområde	-25°C till +70°C
Vikt utan batteri	80 g

ANVÄND MASKINEN ENLIGT ANVISNINGARNA

Lasermätinstrumentet är avsett att användas för mätning av avstånd och lutningar.

Maskinen får endast användas för angiven tillämpning.

TABELL MED FELKODER

Kod	Beskrivning	Lösning
Err01	Utanför mätområdet	Utför mätningen inom det avsedda området.
Err02	Reflekerad signal är för svag	Välj en bättre yta.
Err03	Utanför visningsområdet (max. värde: 99.999) t.ex. ligger resultatet av arean eller volymen utanför visningsområdet	Kontrollera om värdena och stegen är korrekta.
Err04	Fel i Pythagorasberäkningen	Kontrollera om värdena och stegen är korrekta.
Err05	Batteri svagt	Sätt i nya batterier.
Err06	Utanför arbetstemperaturområdet	Utför mätningen inom det angivna arbetstemperaturområdet.
Err07	För ljusst omgivningsljus	Fördunkla delområde

Pythagoras
Höjdskillnad

Mätnivå

Längdmätning

Minimum/maximum för kontinuerlig mätning

Addition/subtraktion

PÅ/MÄTNING

- ▶ På
- ▶ Mätning
- ▶ Kontinuerlig mätning (tryck 2 sek)
Min./max. funktion

ADDITION / SUBTRAKTION

- ▶ Addera värde
- ▶ Navigera i minnet

AREA/VOLYM

- ▶ Area (tryck 1x)
- ▶ Volym (tryck 2x)
- ▶ Indirekt ytmätning (tryck 3x/4x)

PÅSLAGNING

- ▶ På
- ▶ Av (tryck 2 sek)
- ▶ Återställ

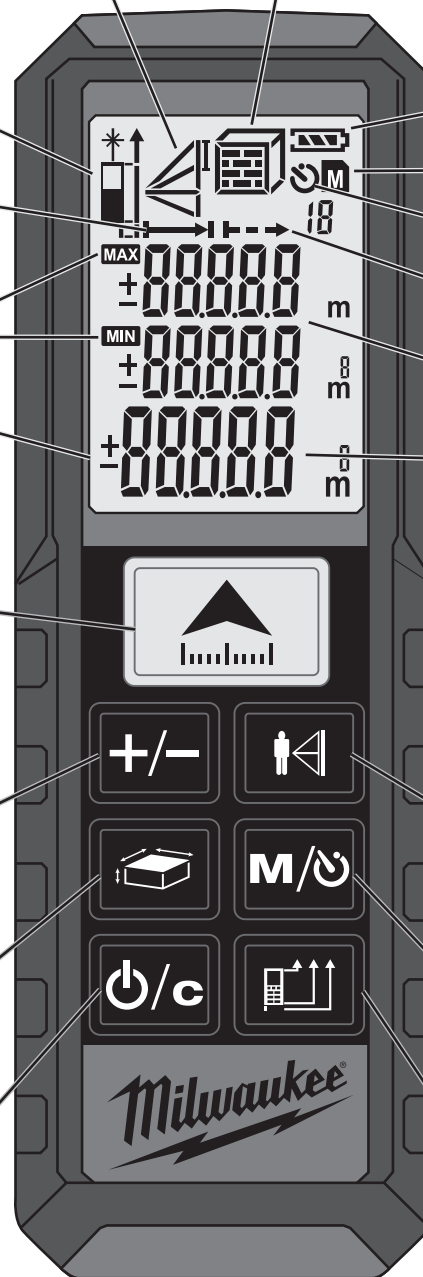

Area/volym
Indirekt ytmätning

Batteristatus

Minne

Timer

Kontinuerlig mätning

Mellanvärden

Totalvärde

PYTHAGORAS

- ▶ Pythagoras 1 (tryck 1x)
- ▶ Pythagoras 2 (tryck 2x)
- ▶ Pythagoras 3 (tryck 3x)

MINNE

- ▶ Timer 3-15 sek (tryck 1x)
- ▶ Minne 1-20 (tryck 1x 2 sek)
- ▶ Ta fram sparade värden (tryck flera gånger)

BYT MÄTNIVÅ

- ▶ Framtill
- ▶ Baktill
- ▶ Hörnpinne

BYTE AV BATTERI

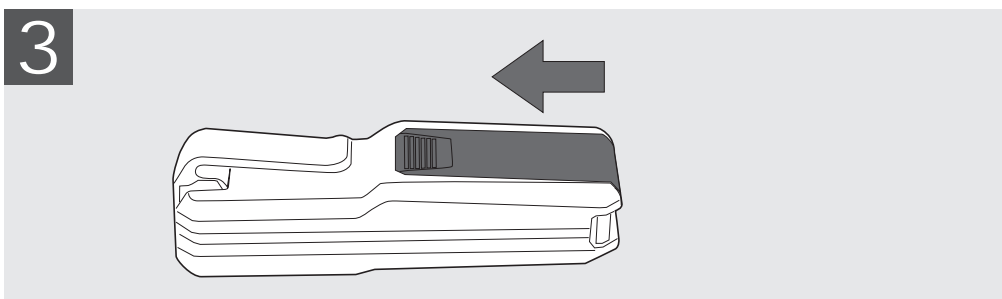
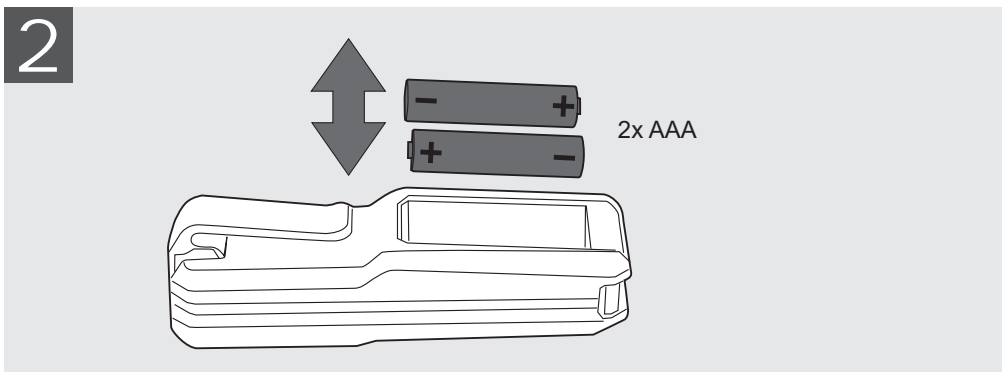
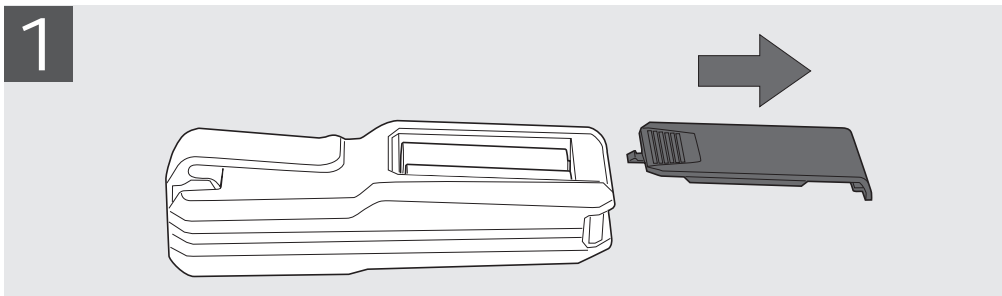
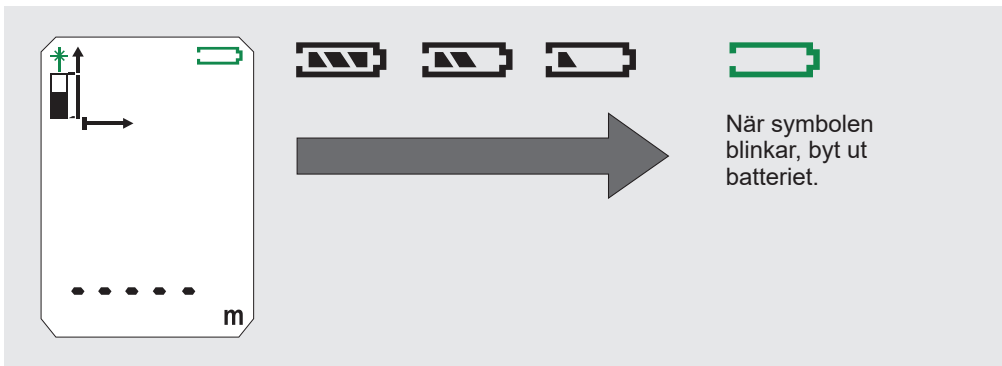

HÖRNPINNE

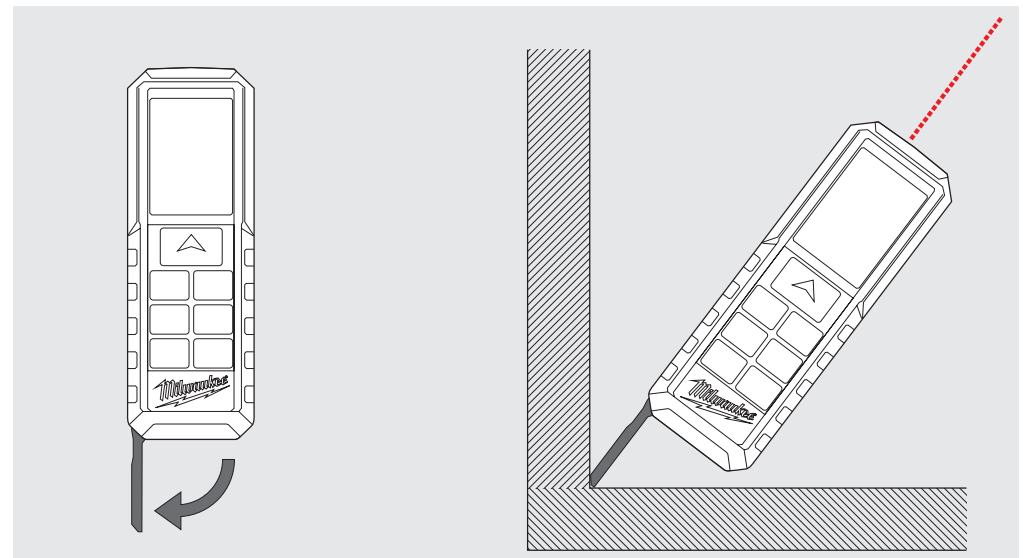

BÄLTSHÄLLARE

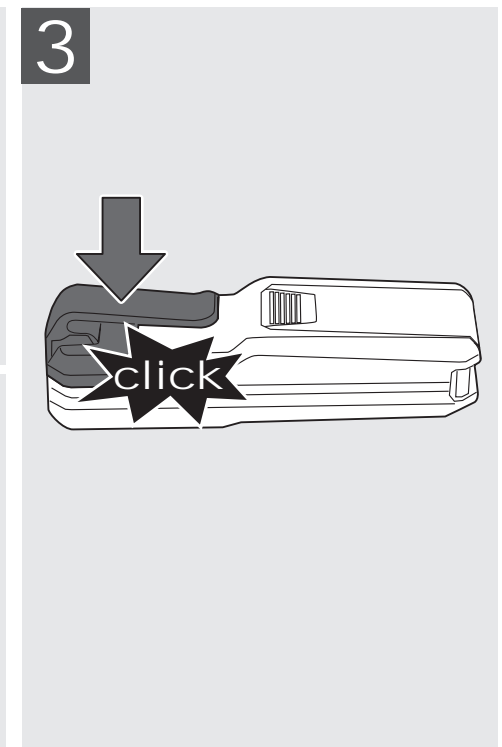
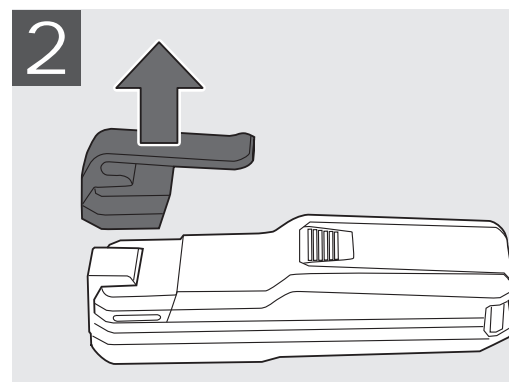
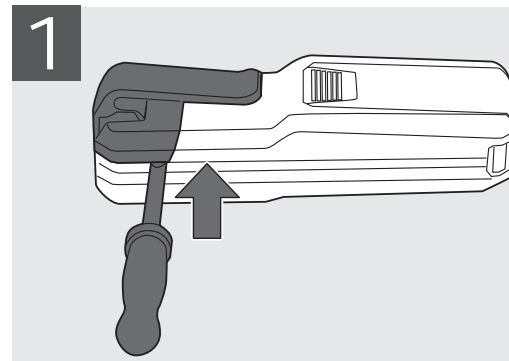

FUNKTIONSKNAPP, PYTHAGORAS, MÄTNIVÅ

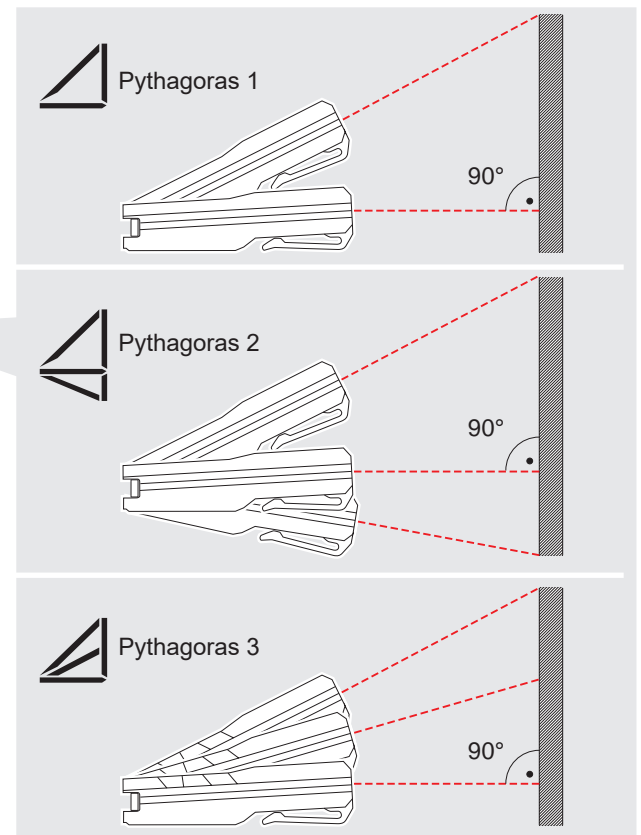
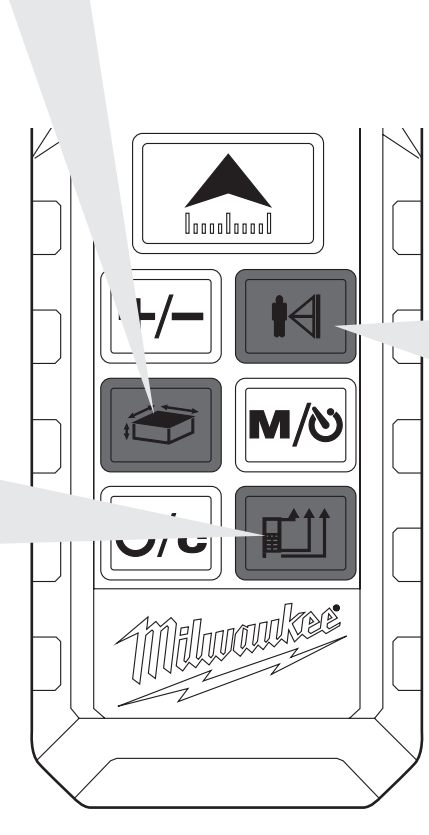
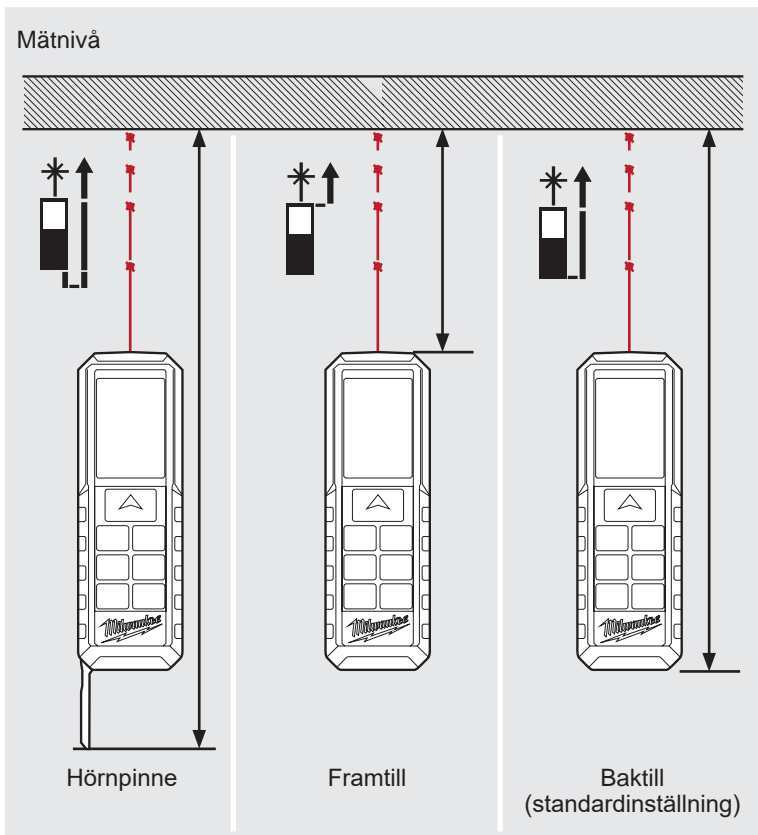
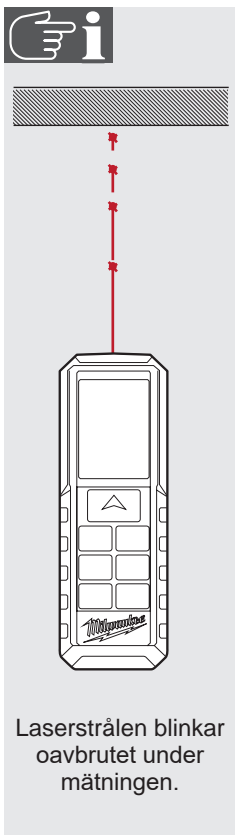
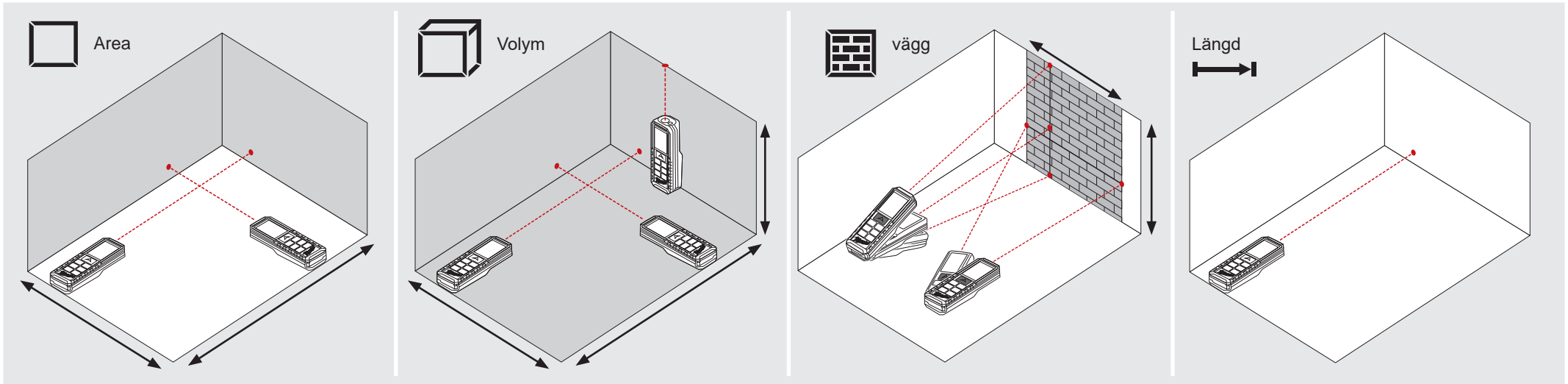

ENKEL LÄNGDMÄTNING

0

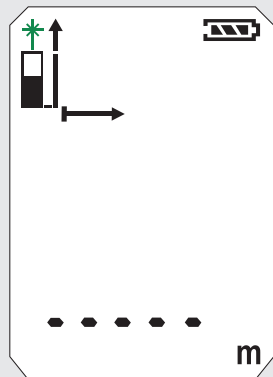

1

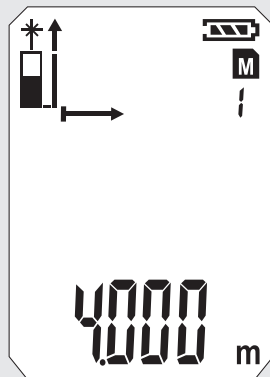

2

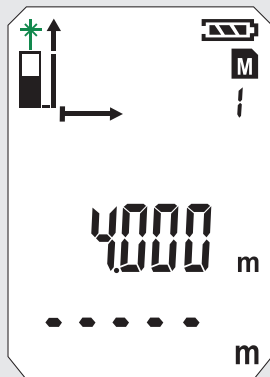

3

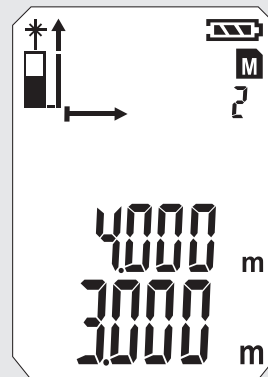

4

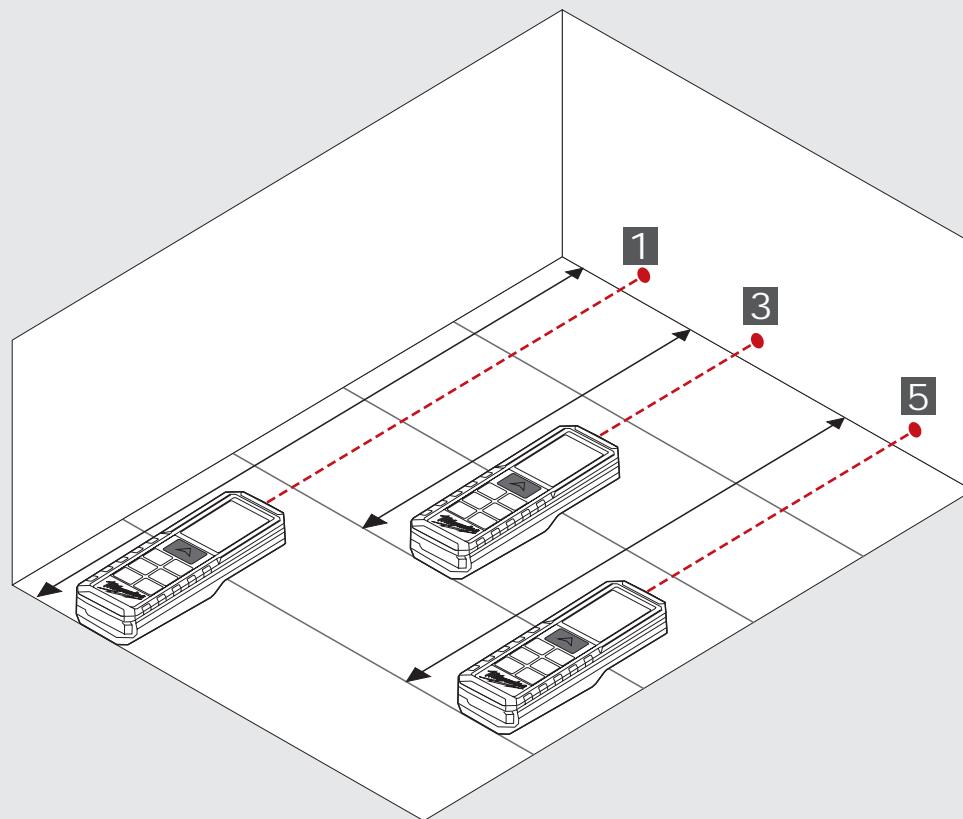
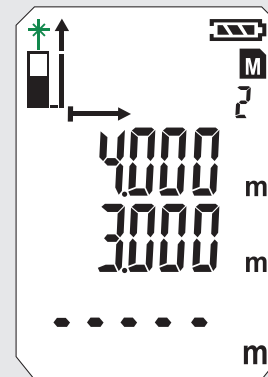

5

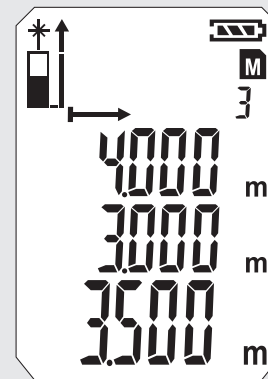

KONTINUERLIG MÄTNING/MINIMUM-MAXIMUM MÄTNING

0

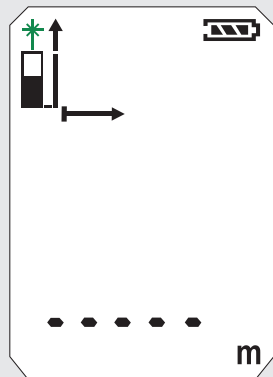

1

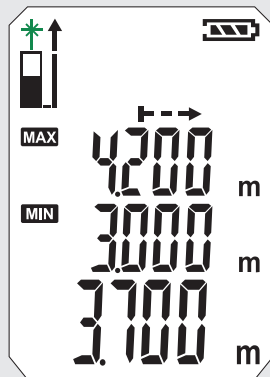

2

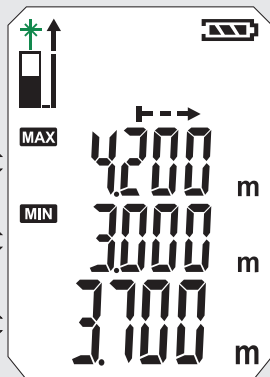

3



Stop
MIN / MAX

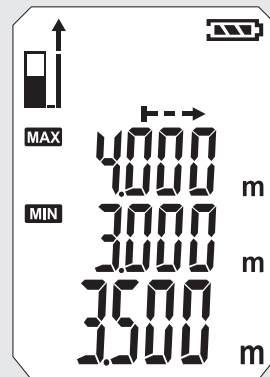

4

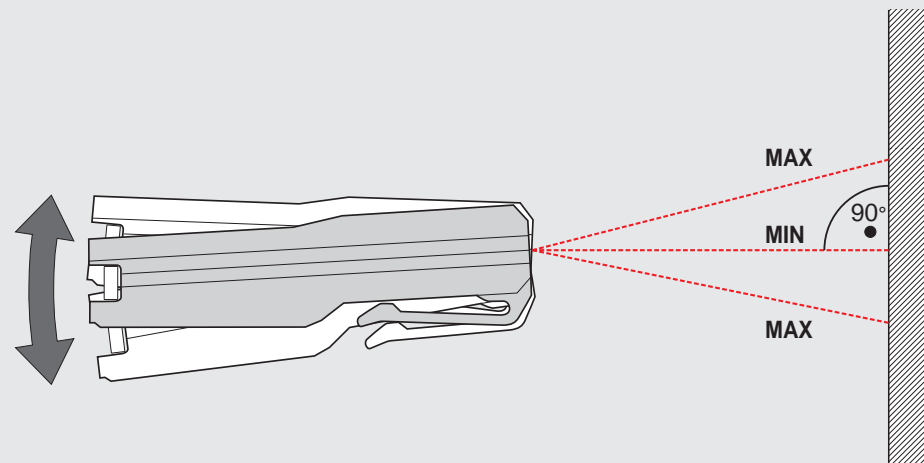
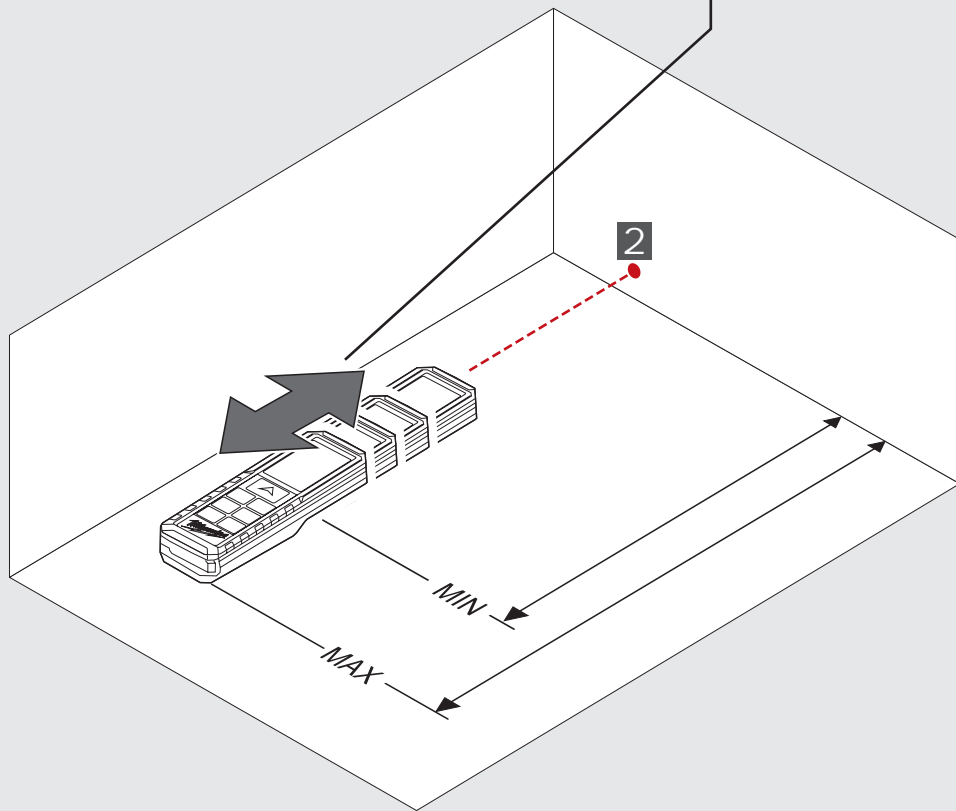
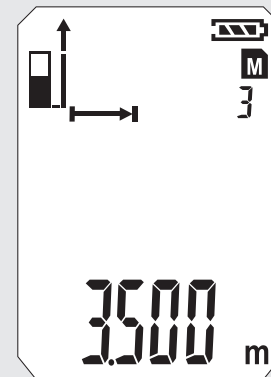

ADDITIONS- / SUBTRAKTIONSMESSUNG

0

1

2

3

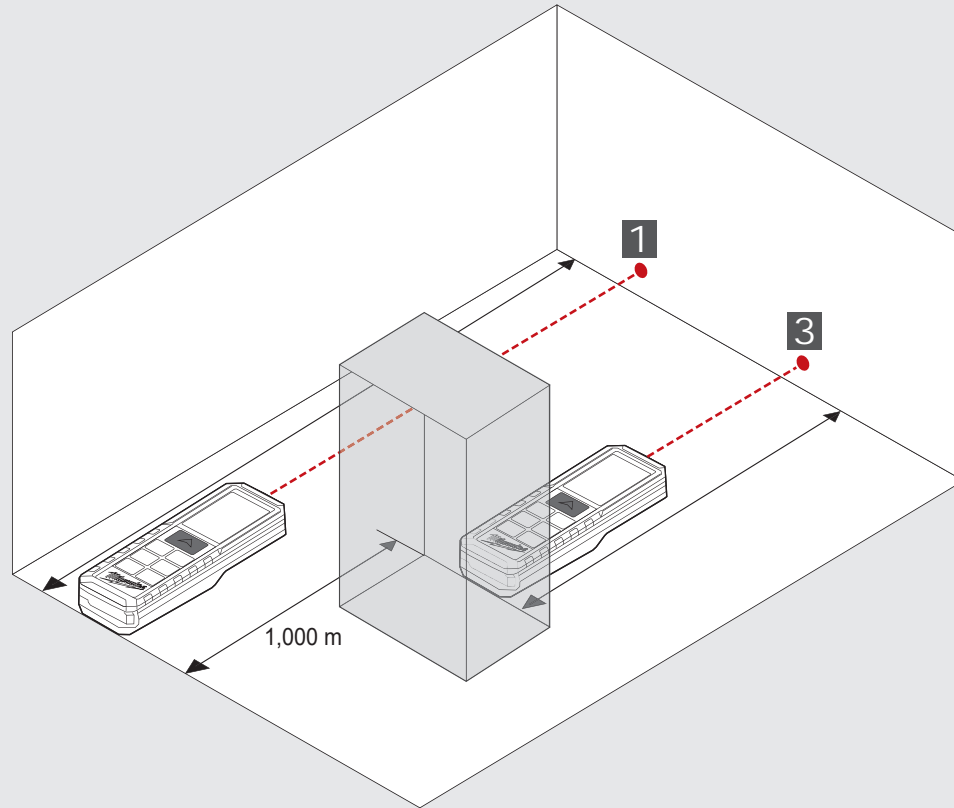
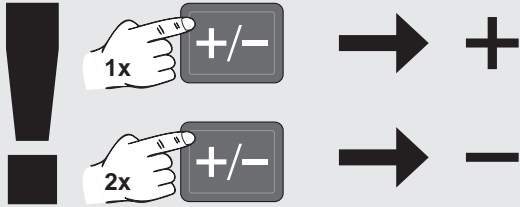
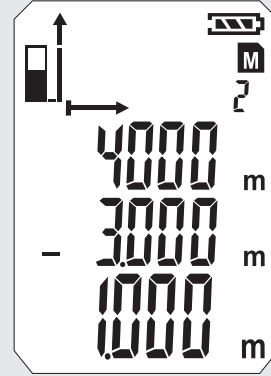
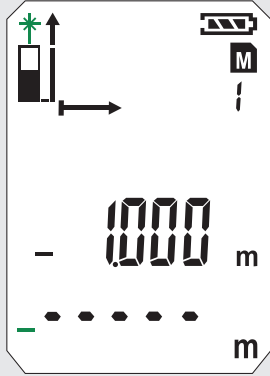
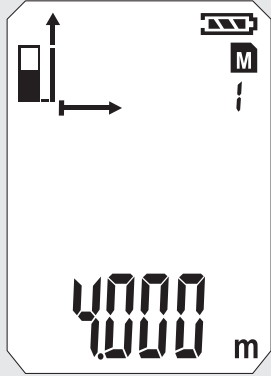
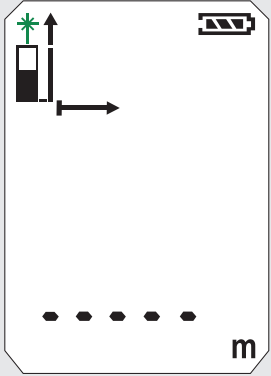
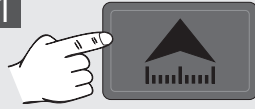

AREAMÄTNING

0



1



2

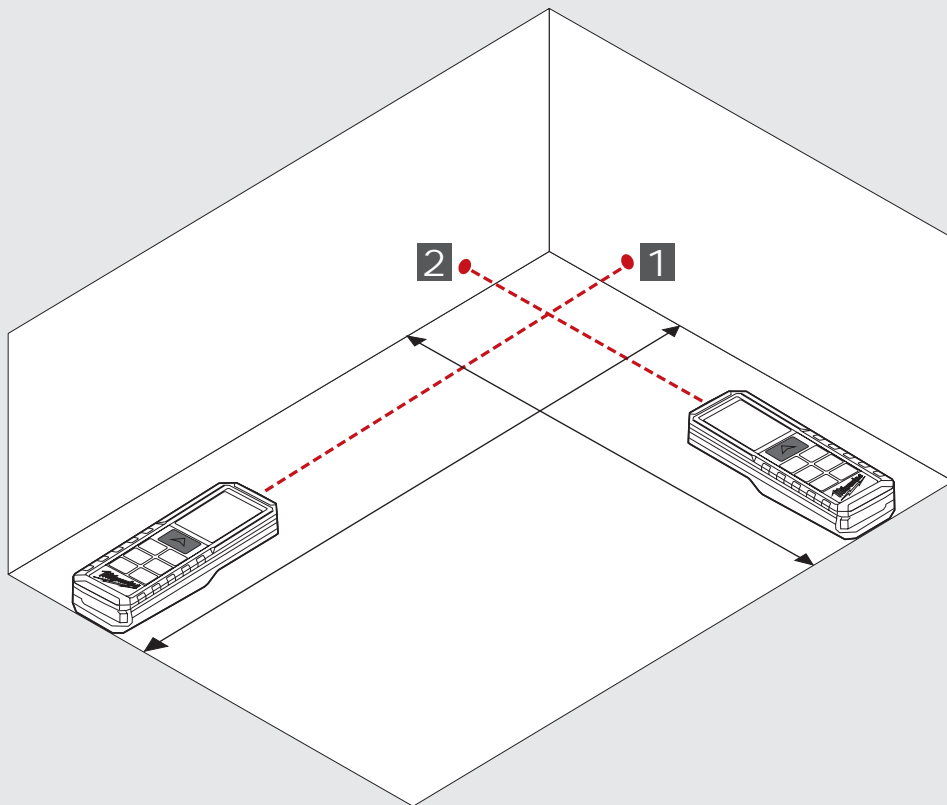
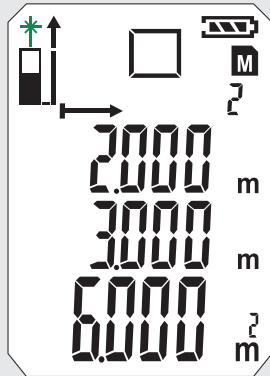
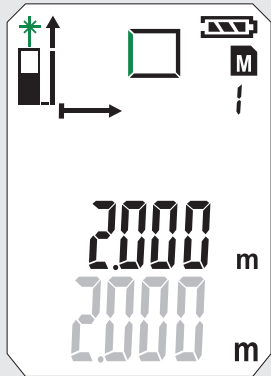
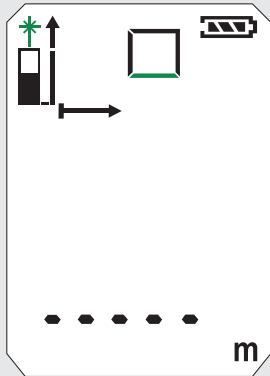

VOLYMMÄTNING

0

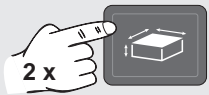

1



2



3

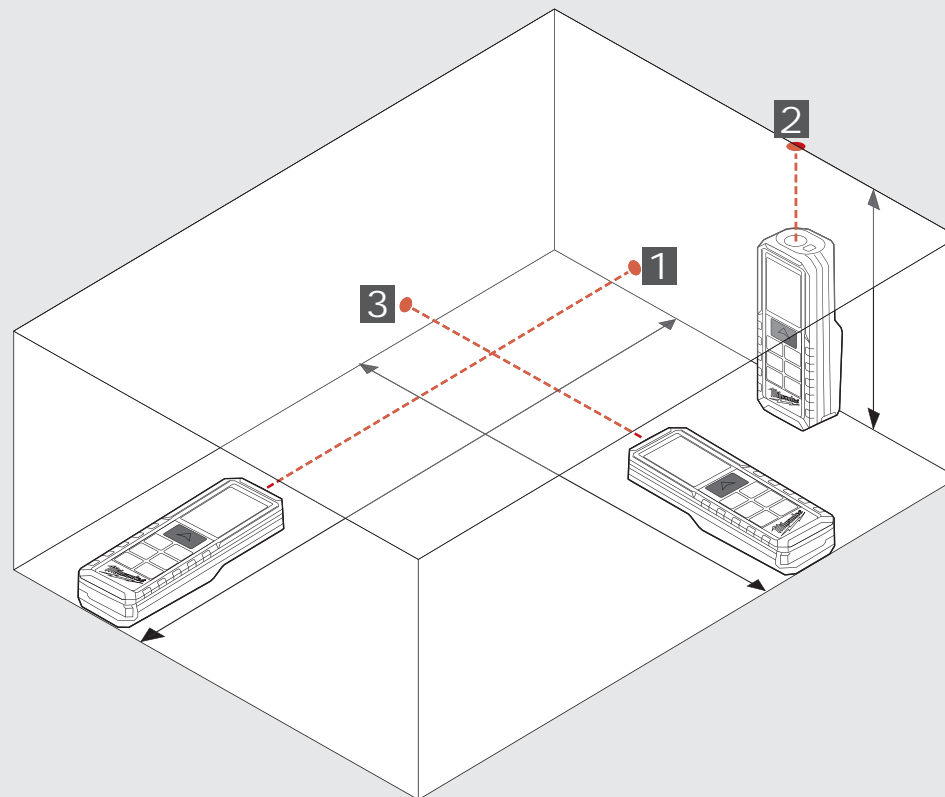
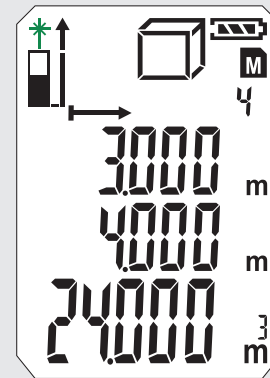
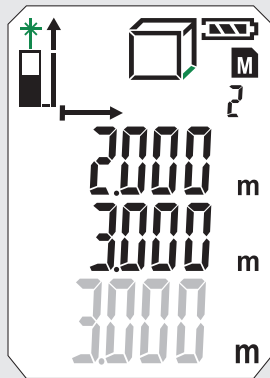
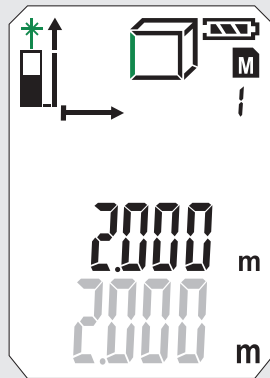
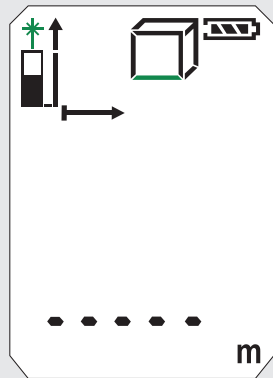
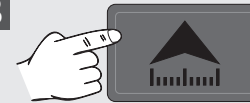

INDIREKT MÄTNING (PYTHAGORAS 1)

0



1



2

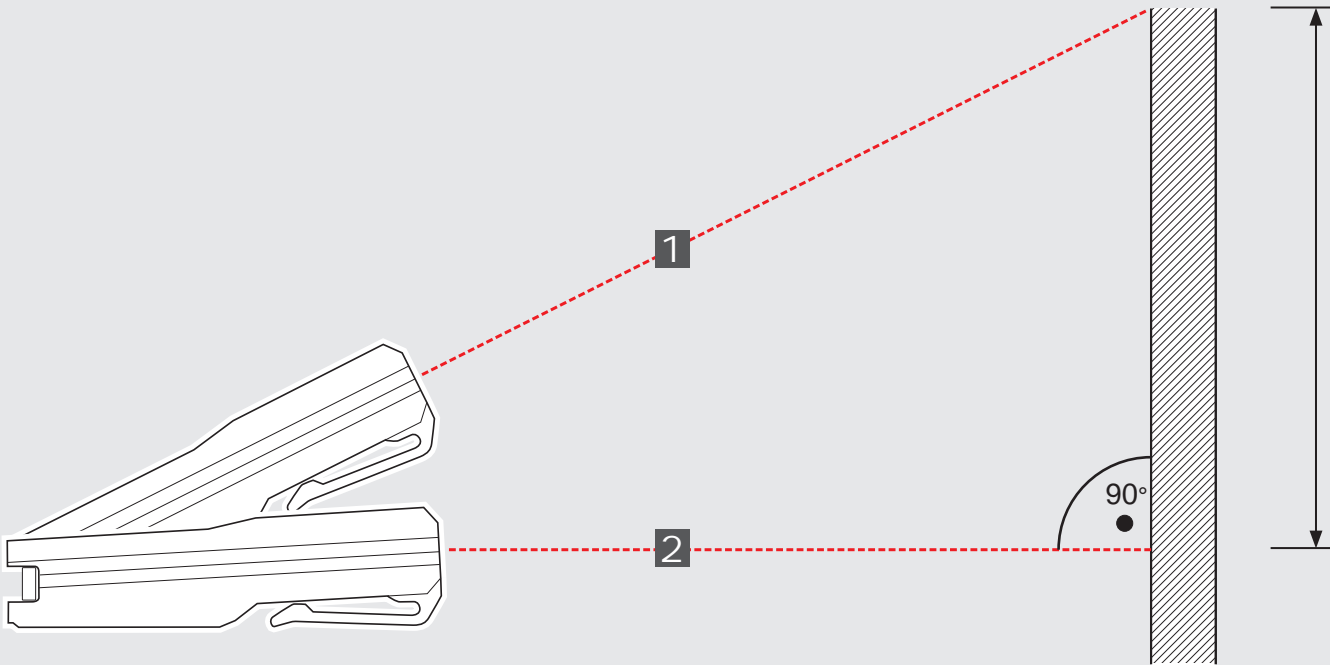
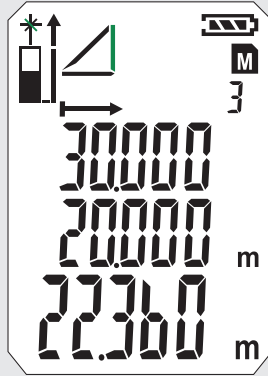
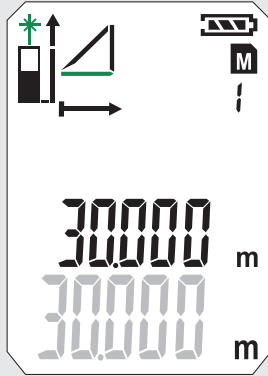
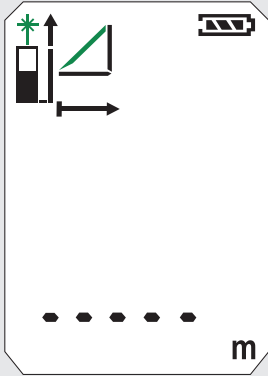

INDIREKT MÄTNING (PYTHAGORAS 2)

0

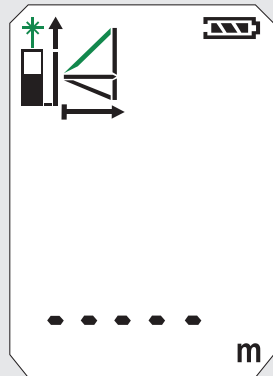

1

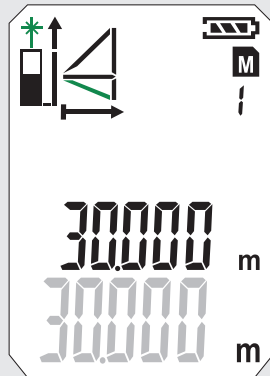

2

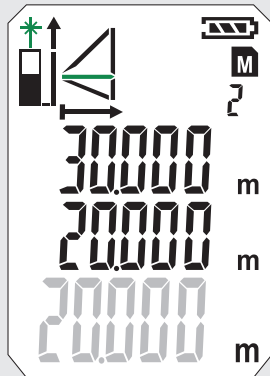

3

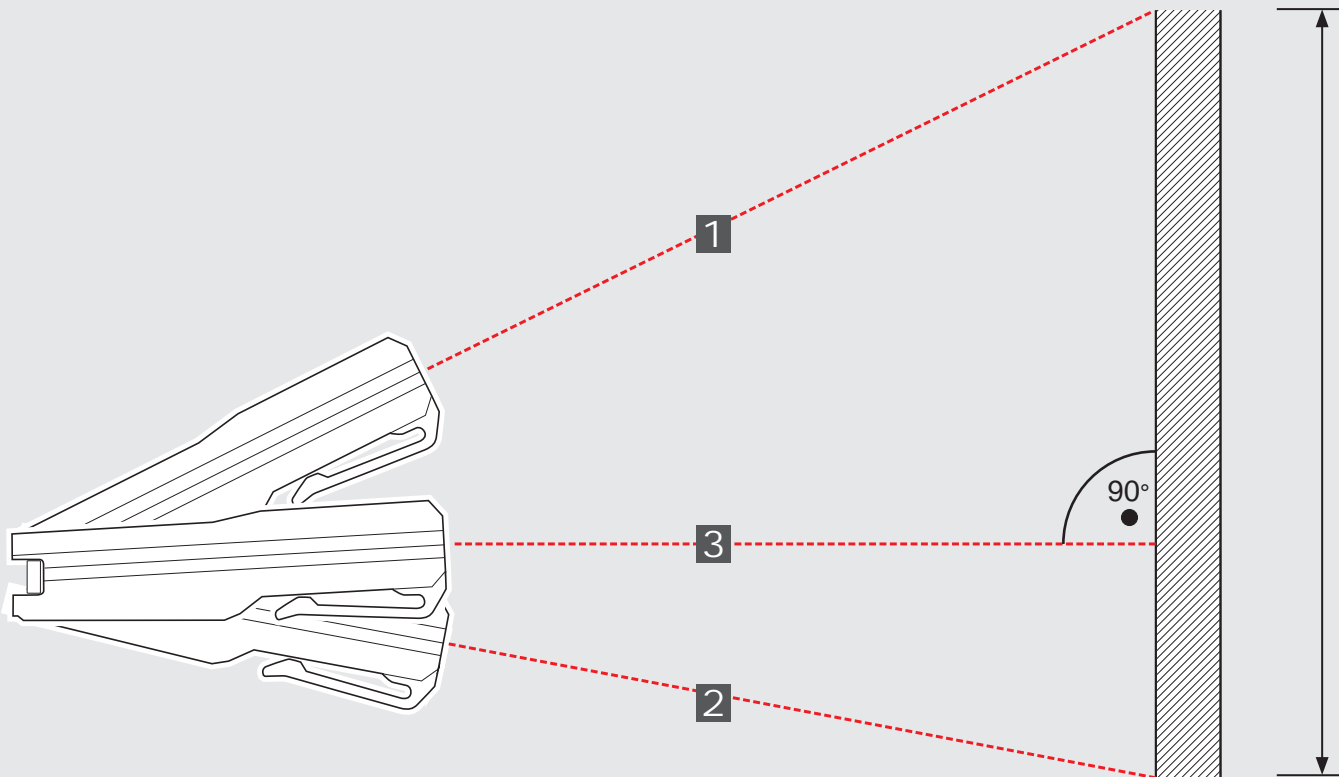
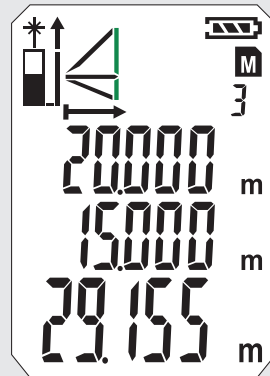

INDIREKT MÄTNING (PYTHAGORAS 3)

1



2







3

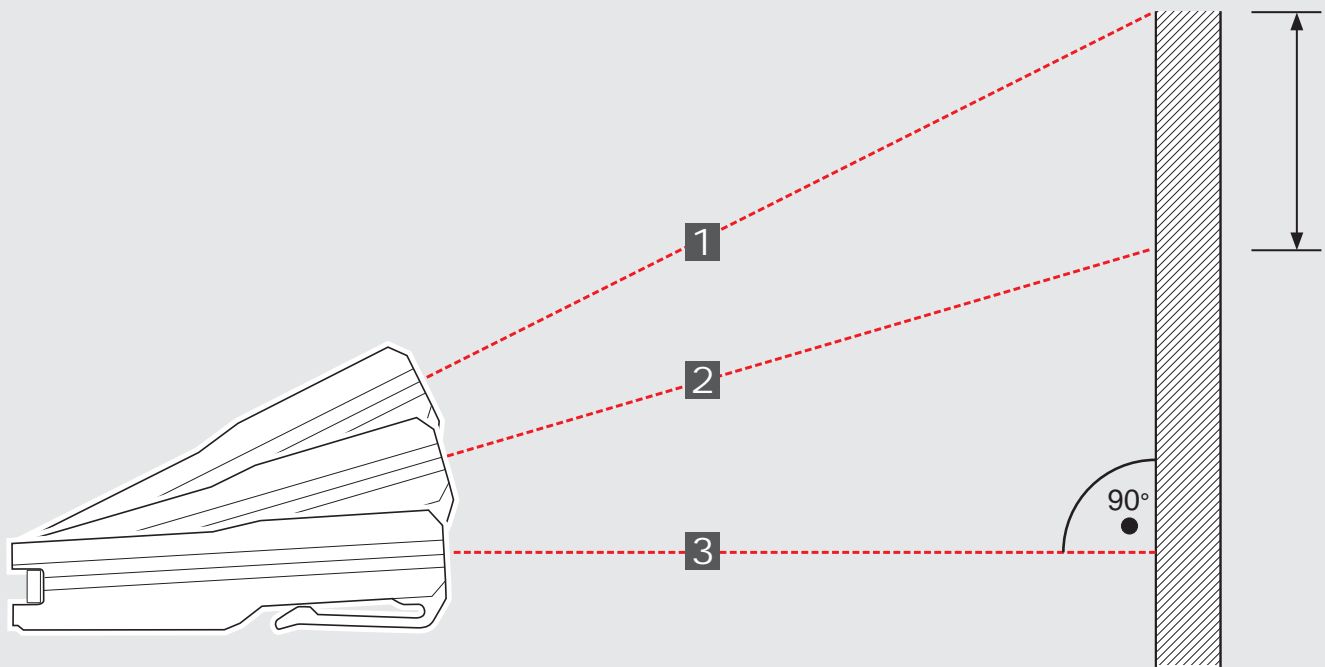
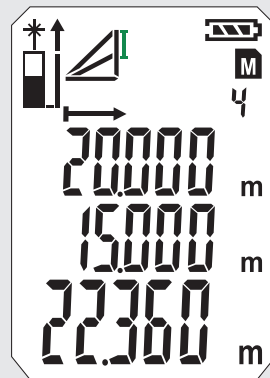
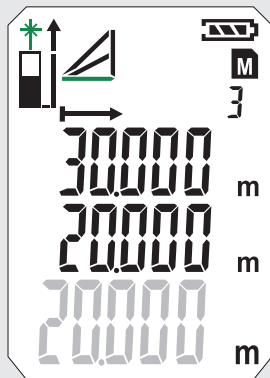
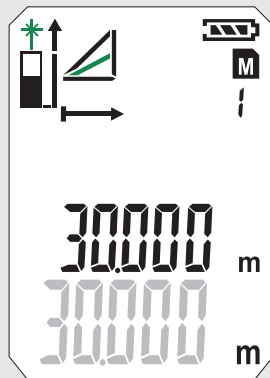
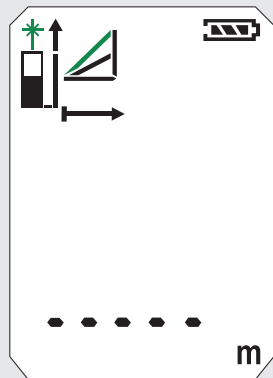



4



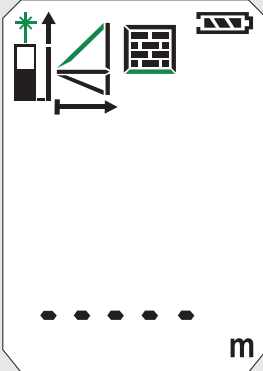
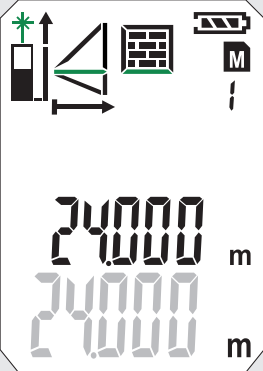
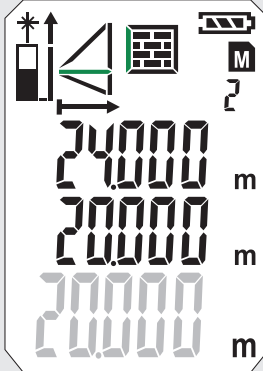
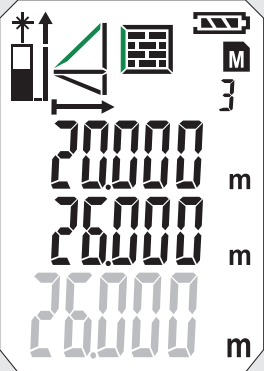
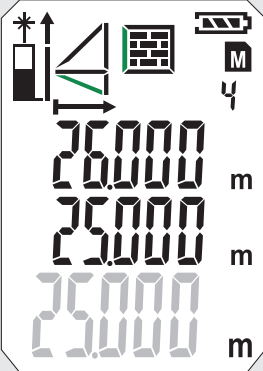

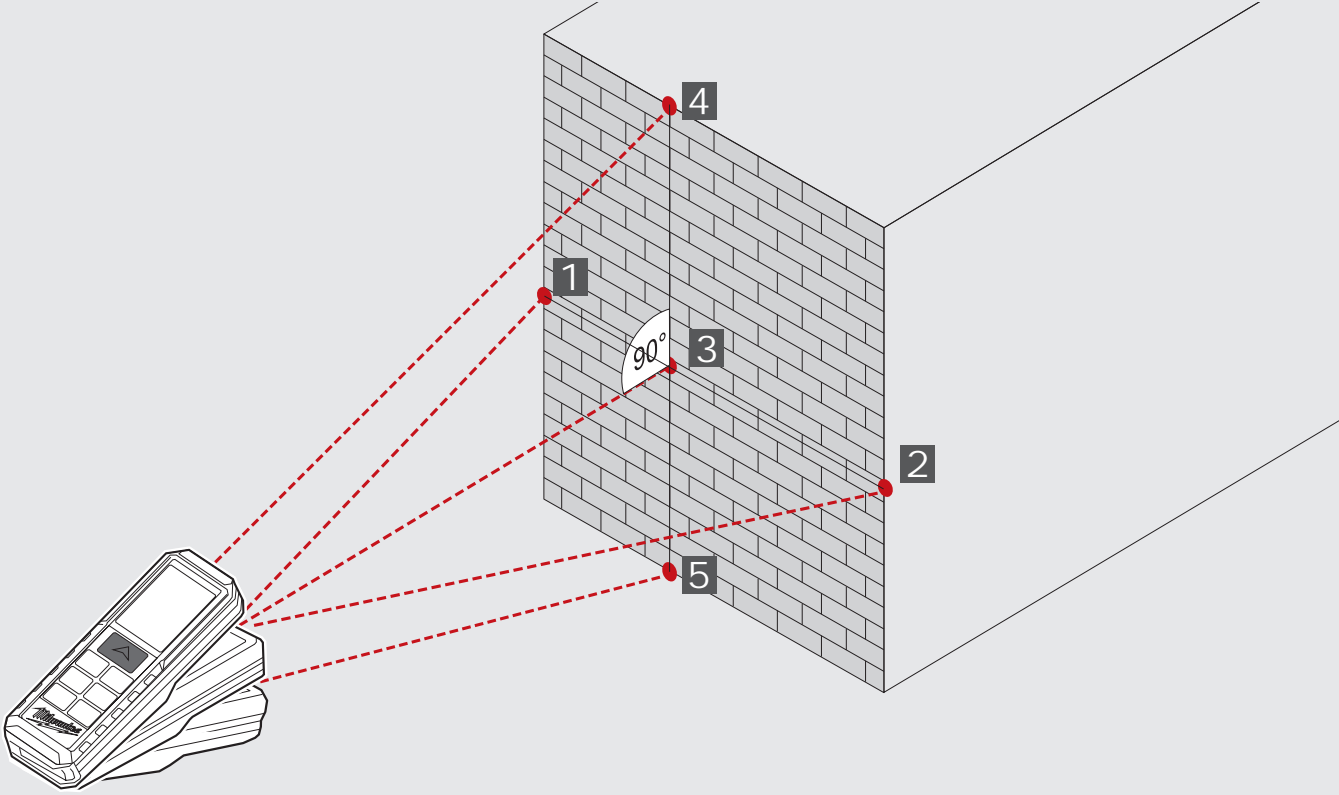

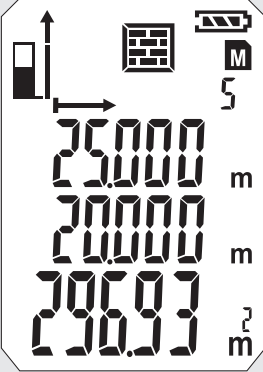
MÄTNING VÄGGAREA (SCENARIO 1)

<p>0</p> 	<p>1</p> 	<p>2</p> 	<p>3</p> 	<p>4</p> 
				

	<p>5</p> 
	

MÄTNING VÄGGAREA (SCENARIO 2)

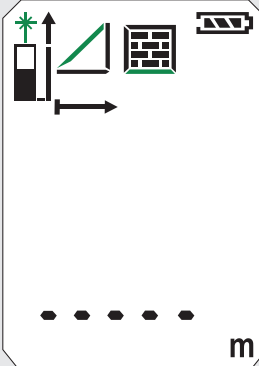
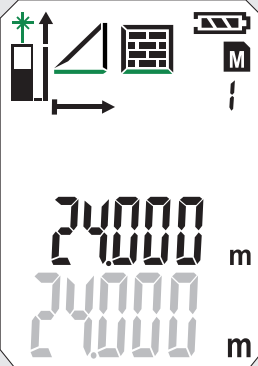
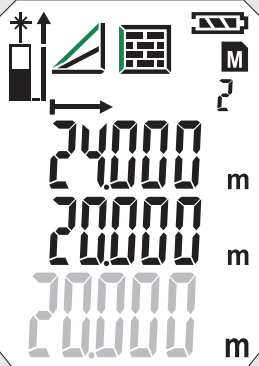
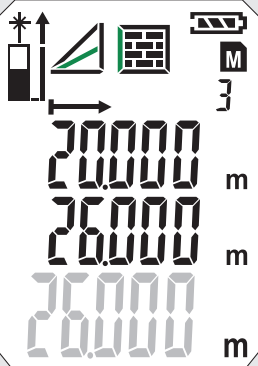
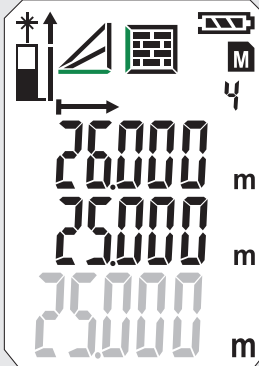
<p>0</p> 	<p>1</p> 	<p>2</p> 	<p>3</p> 	<p>4</p> 
				

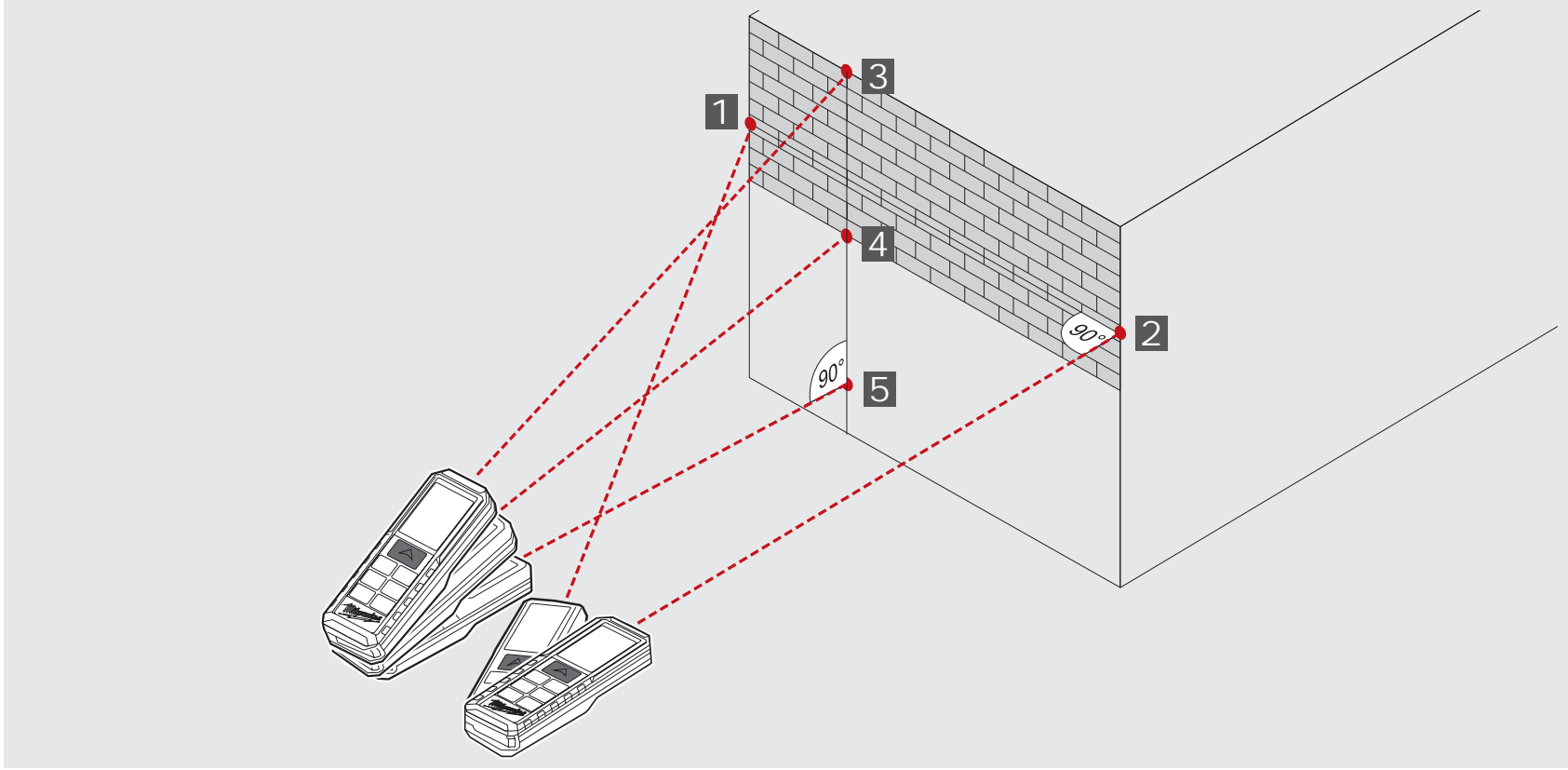

5

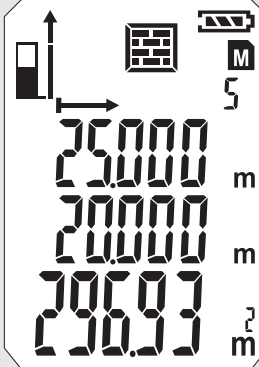



TIMER

Med timern kan mätningen utlösas tidsfördröjt för att t.ex. placera en byggnadsdel i mätstrålen.

Tryck på knappen .

- Symbol visas

Genom att man trycker på knappen  kan timern ställas in på mellan 3 och 15 sek.

Tryck på knappen .

- Sekunderna räknas ner till mätningen.

- Vid 0 utförs mätningen.

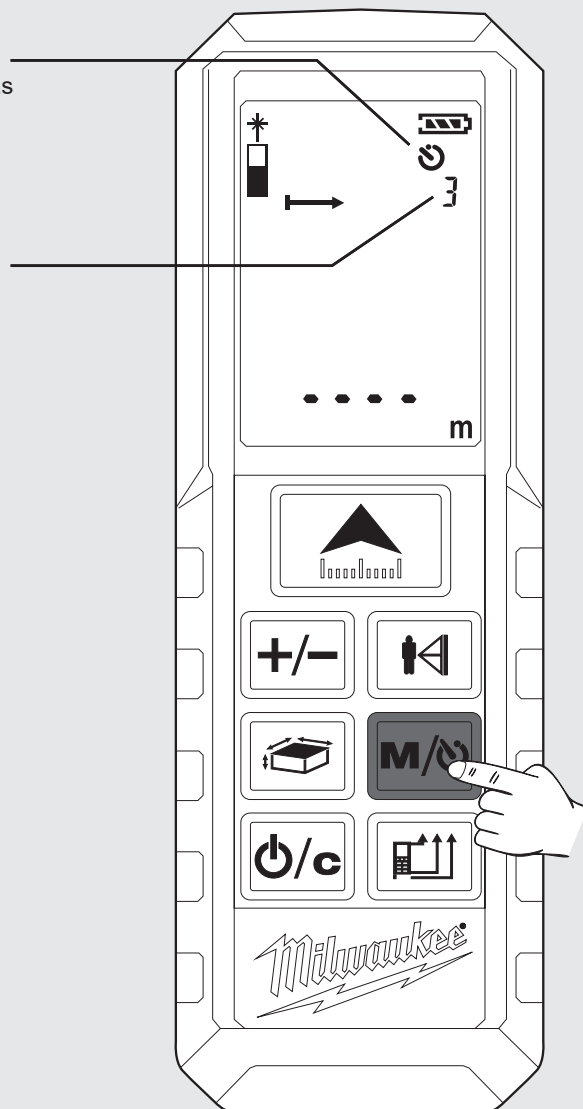

MINNE

Mätvärdena sparas automatiskt fortlöpande i minnet.

De sparade värdena kan hämtas med knappen .

Tryck på knappen  under 2 sek

- Symbol och minnesplats visas.

- Tillhörande mätstorlek visas.

- Det sparade värdet visas på huvudraden.

- Ta fram sparade värden genom att tryckan knappen  flera gånger.

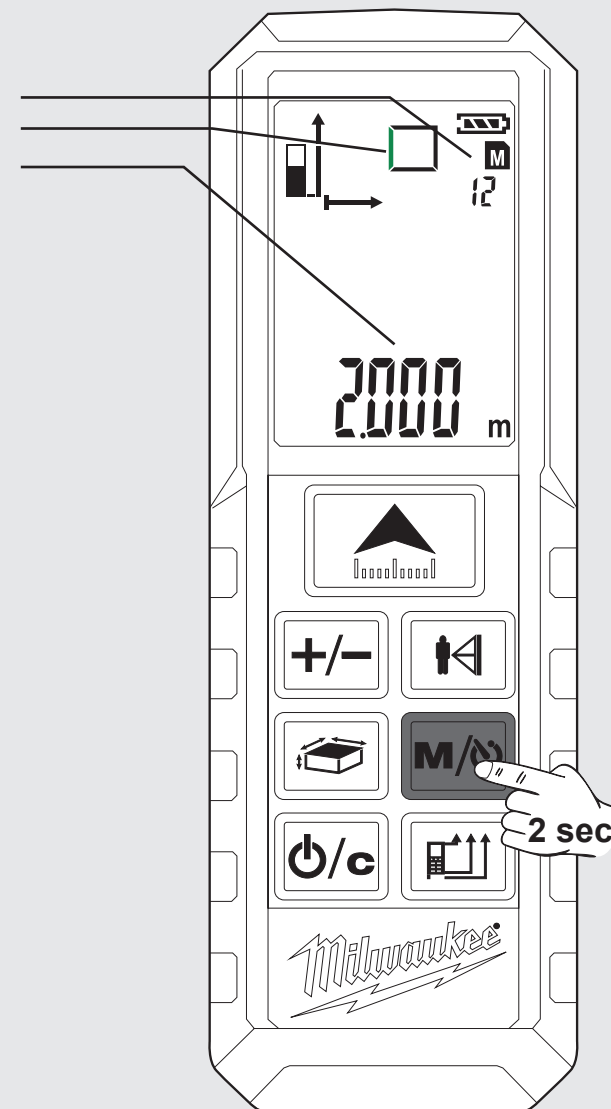

GRUNDLÄGGANDE FUNKTIONSSÄTT BESKRIVET MED EN AREAMÄTNING SOM EXEMPEL (1)

1 Start

Tryck på knappen .
⚠ OBS! Laserstrålen är påslagen!
 Rikta inte mot personer!

Lasersymbolen blinkar
 (blinkljuset visas här grönt).

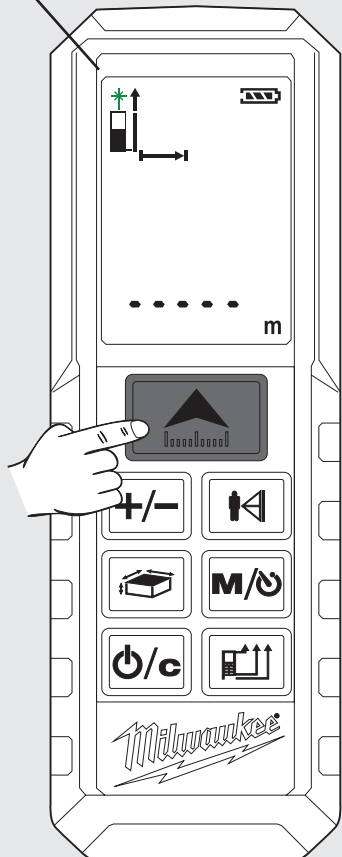

2 Välj mätnivå

Standardinställning efter påslagning: baktill
 Tryck 1x -> hörnpinne
 Tryck 2x -> framtill
 Tryck 3x -> baktill

Symbol visas

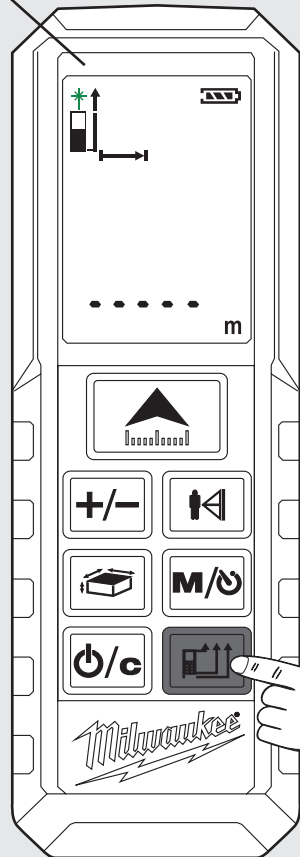

3 Välj funktion

Efter att instrumentet slås på står det alltid på längdmätning.
 Tryck 1x - areamätning

- Symbol visas
 - Mätstorlek blinkar
 (blinkljuset visas här grönt).

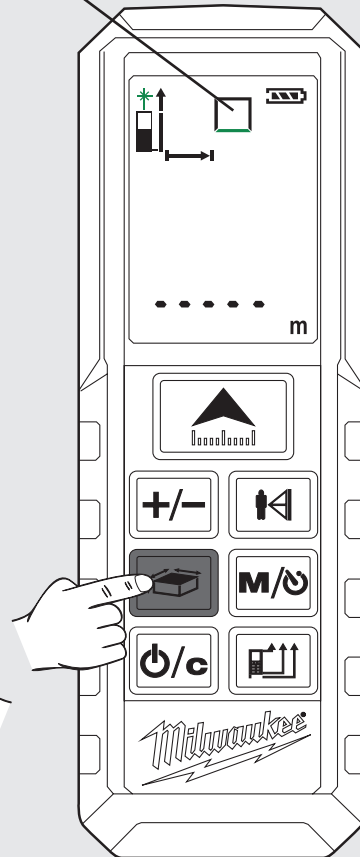

4 Mäta längd

Rikta in instrumentet och tryck på knappen .

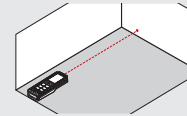

- Mätvärdet visas kort på huvudraden.
 - Mätvärdet hoppar efter 1 sek till raden ovanför.
 Mätvärdet sparas i minnet under det fortlöpande numret.
 Den andra mätstorleken blinkar. Instrumentet är redo för mätning av det andra värdet.

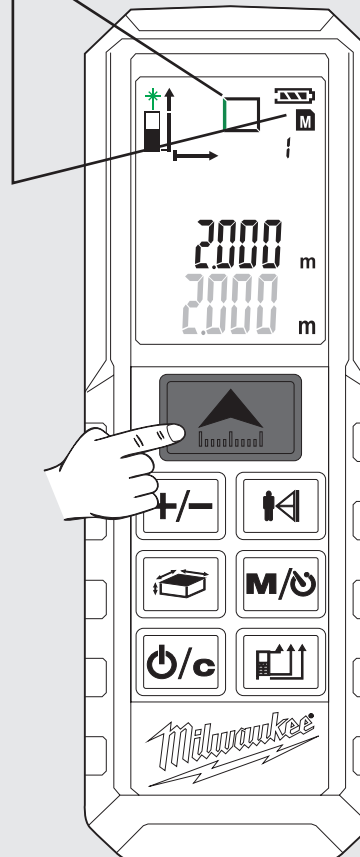

5 Mäta bredd

Rikta in instrumentet och tryck på knappen .

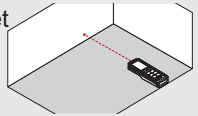

- Mätvärdet visas kort på huvudraden.
 - Mätvärdet hoppar efter 1 sek till raden ovanför.
 Mätvärdet sparas i minnet under det fortlöpande numret.
 - Resultatet visas på huvudraden och sparas i minnet under det fortlöpande numret.

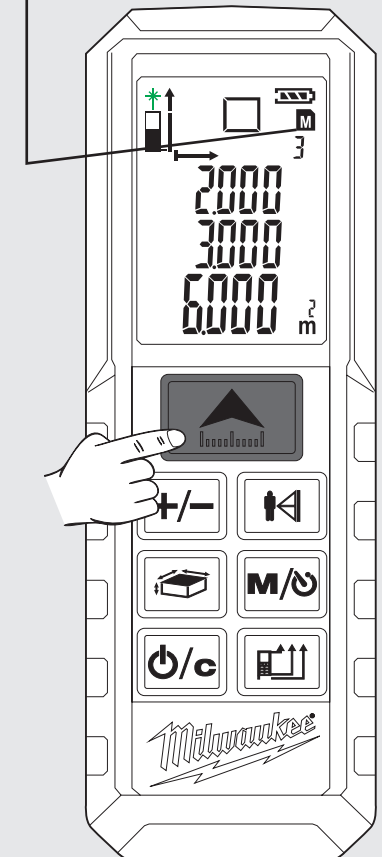

GRUNDLÄGGANDE FUNKTIONSSÄTT BESKRIVET MED EN AREAMÄTNING SOM EXEMPEL (2)

6 Hämta sparade värden

Tryck på knappen  under 2 sek.

Paina näppäintä  # useamman kerran.

- De sparade värdena visas på huvudraden.

- Den tillhörande symbolen visas och mätstorleken blinkar (blinkljuset visas här grönt).

7 Stänga minnet

Tryck på knappen .

8 Stänga av

Tryck på knappen  under 2 sek (minnet måste stängas först).

- Instrumentet stängs av.

- Om ingen knapp tryck in under 3 sek stängs instrumentet av automatiskt.

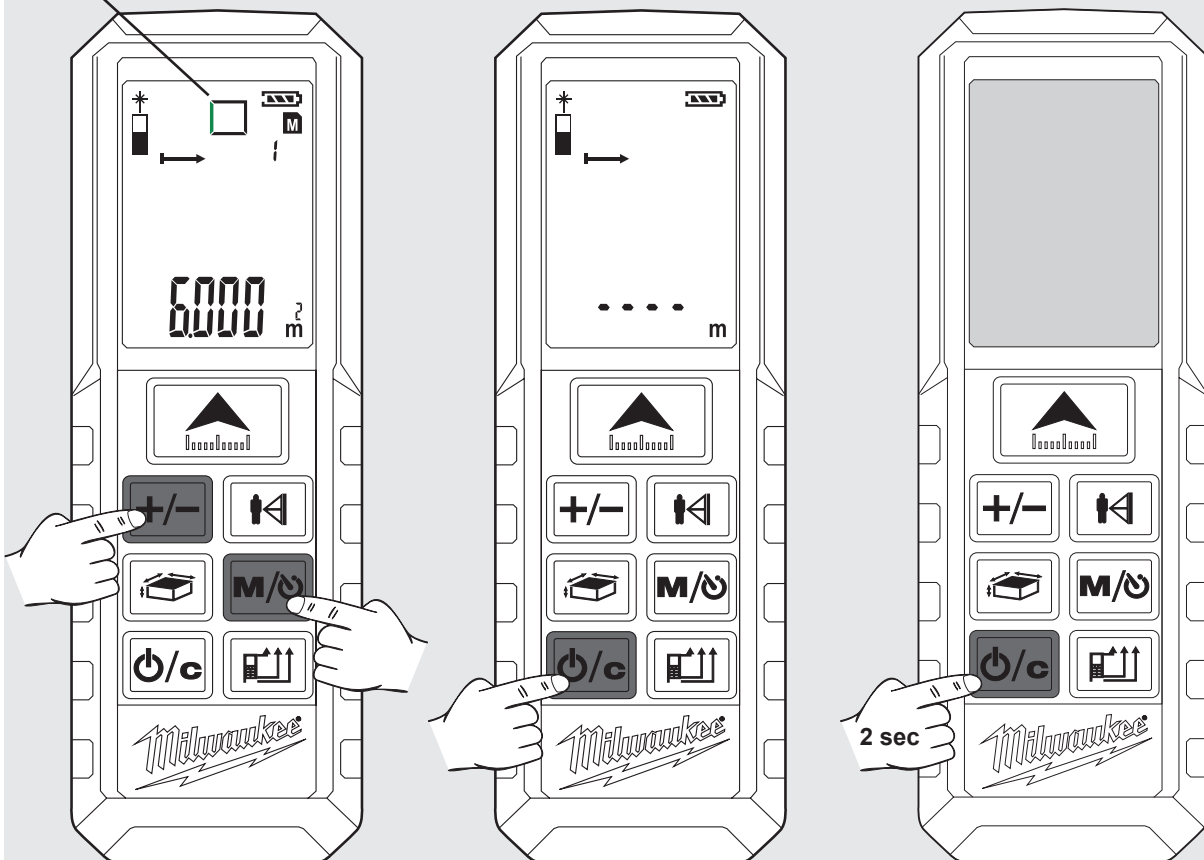

SISÄLTÖ

Tärkeitä turvallisuusohjeita.....	1
Tekniset arvot	2
Tarkoituksenmukainen käyttö	2
Virhekooditaulukko	2
Yleiskuva	3
Paristojen vaihtaminen	4
Nurkkapuikko.....	4
Vyökannatin.....	4
Toimintonäppäin, Pythagoras, mittaustaso.....	5
Yksinkertainen pituusmittaus.....	6
Jatkuva mittaus / minimi-maksimi-mittaus	7
Lisäys- / vähennysmittaus	8
Pinta-alamittaus.....	9
Tilavuusmittaus.....	10
Epäsuora mittaus (Pythagoras 1).....	11
Epäsuora mittaus (Pythagoras 2).....	12
Epäsuora mittaus (Pythagoras 3).....	13
Seinän pinta-alamittaus (malli 1).....	14
Seinän pinta-alamittaus (malli 2).....	15
Ajastin.....	16
Muisti	16
Perusluontoinen toimintatapa pinta-alamittauksen (1) esimerkillä näytettynä.....	17
Perusluontoinen toimintatapa pinta-alamittauksen (2) esimerkillä näytettynä.....	18

TÄRKEITÄ TURVALLISUUSOHJEITA



Älä käytä tuotetta ennen kuin olet tutkinut Turvallisuusohjeet ja Käyttäjän käsikirjan oikealta CD-levyltä.

Laserluokka

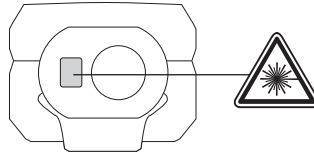

VAROITUS:

Se on Luokan 2 laser-tuote normin EN60825-1:2014 mukaan.



λ 650 nm P<1 mW

Varoitus:

Vältä katsomasta suoraan laseriin. Lasersäde saattaa häikäistä silmät salaman tavoin ja aiheuttaa ohimenevän sokaistumisen.

Älä katso suoraan lasersäteeseen, äläkä suuntaa sitä tarpeettomasti kohti muita ihmisiä.

Älä tähtää muihin henkilöihin.

Varoitus:

Älä käytä laserlaitetta lasten lähettyvillä äläkä anna lasten käyttää laserlaitetta.

Huomio! Heijastava pinta saattaisi heijastaa lasersäteen takaisin käyttäjään tai muihin henkilöihin.

Pidä raajat turvallisen matkan päässä liikkuvista osista.

Suorita säännöllisesti koemittauksia. Eryityisesti ennen, aikana ja tärkeiden mittausten jälkeen.

Tarkkaile virheellisiä mittauksia, jos tuote on vial- linen, tai se on pudonnut, tai sitä on väärinkäytetty tai muutettu.

Varoitus: Ohjauslaitteiden, säätöjen tai muiden kuin käsikirjassa määritettyjen prosessien suorittaminen voi altistaa vaaralliselle säteilylle.

Lasermittarin käyttöalue on rajoitettu. (Katso kohtaa "Tekniset tiedot"). Jos yrität mitata pienimmän tai suurimman alueen ulkopuolelta, niin tulokset ovat epätarkkoja. Jos laitetta käytetään vaikeissa olosuhteissa, kuten liian kuumassa, liian kylmässä, hyvin kirkkaassa auringonvalossa, sateessa, lumisateessa, sumussa tai muissa näkyvyyttä rajoittavissa olosuhteissa, niin mittaustulokset voivat olla epätarkkoja.

Kun tuot lasermittarin lämpimästä tilasta kylmään tilaan (tai päinvastoin), odota, kunnes laite on sopeutunut ympäristön muuttuneeseen lämpötilaan.

Säilytä lasermittaria aina sisätiloissa ja suojaa laitetta iskuilta, tärinältä tai äärimmäisiltä lämpötiloilta.

Suojaa lasermittaria pölyltä, kosteudelta ja suurelta ilmankosteudelta. Se saattaa tuhota laitteen sisäiset osat tai vaikuttaa sen tarkkuuteen.

Älä käytä mitään syövyttäviä puhdistusaineita tai liuotteita. Puhdista laite vain puhtaalla, pehmeällä rievulla.

Vältä lasermittariin kohdistuvia iskuja tai sen putoamista. Laitteen tarkkuus tulee tarkastaa, jos se on pudonnut tai siihen on kohdistunut muunlaista mekaanista rasitusta.

Vain valtuutettu ammattihenkilöstö saa suorittaa tämän laserlaitteen tarvittavat korjaustyöt.

Älä käytä tuotetta räjähdysvaarallisilla alueilla tai aggressiivisissa ympäristöissä.

KKäytä vain valmistajan suosittelemia latureita akkujen lataamiseen.

Älä hävitä käytettyjä paristoja, sähkö- ja elektroniikkaromua lajittelemattomana yhdyskuntajätteenä. Käytetyt paristot sekä sähkö- ja elektroniikkaromu on kerättävä erikseen.

Käytetyt paristot, romuakut ja valonlähteet on irrotettava laitteista.

Kysy paikallisilta viranomaisilta tai jälleenmyyjiltä neuvoa kierrättämiseen ja tietoa keräyspisteestä.

Paikalliset säännökset saattavat velvoittaa vähittäiskauppiaat ottamaan käytetyt paristot, sähkö- ja elektroniikkaromun takaisin maksutta.

Panoksesi käytettyjen paristojen sekä sähkö- ja elektroniikkalaiteromun uudelleenkäytössä ja kierrätyksessä auttaa vähentämään raaka-aineiden kysyntää.

Käytetyt paristot, etenkin litiumia sisältävät, sekä sähkö- ja elektroniikkaromu sisältävät arvokkaita, kierrätettäviä materiaaleja, jotka saattavat vaikuttaa haitallisesti ympäristöön ja ihmisten terveyteen, jos niitä ei hävitetä ympäristöystävällisesti.

Poista mahdolliset henkilökohtaiset tiedot hävitettävästä laitteesta.

 Euroopan säännönmukaisuusmerkki

 Iso-Britannian standardinmukaisuusmerkki

 Ukrainan säännönmukaisuusmerkki

 Euraasian säännönmukaisuusmerkki

TEKNISET ARVOT

Suojausluokka	IP54 (pöly- ja roiskevesisuojuattu)
Optiikka	14 mm
Polttopiste	35 mm
Mittausalue enint.	50 metriä (toleranssi: 55 m)
Mittausalue väh.	0,05 metriä
Absoluuttinen tarkkuus @ < 10 m	± 1,5 mm (max)
Toistotarkkuus @ < 10 m	± 1,5 mm (tyypillisesti enint. 2σ)
Toistotarkkuus @ > 10 m	nousu ± 0,25 mm / metri (tyypillisesti enint. 2σ)
Mittausaika	0,5 s
Näyttötyyppi	LCD (22,7 mm x 31 mm)
Virransyöttö	AAA 2x (alkaline-paristo)
Pariston kesto aika	10000 (yksittäismittausta)
Laserin lähtöteho	0,6 mW ~ 0,95 mW (luokka 2, 650 nm)
Laserpisteen koko	25 x 30 mm @ 16 m (max)
Laserluokka	2
Lasertyyppi	650 nm, < 1 mW
Lasersäteen pystykulma	+1 aste
Lasersäteen vaakakulma	1 aste
Automaattinen laitteen sammutus	180 sekuntia
Automaattinen laserin sammutus	30 sekuntia
Työlämpötila-alue	-10°C - +50°C
Säilytyslämpötila-alue	-10°C - +70°C
Paino ilman paristoa	80 g

TARKOITUKSEN MUKAINEN KÄYTTÖ

Lasermittaria voidaan käyttää etäisyyksien ja kaltevuuksien mittaamiseen.

Älä käytä tuotetta ohjeiden vastaisesti.

VIRHEKOODITAU LUKKO

Koodi	Kuvaus	Poisto
Err01	Mittausalueen ulkopuolella	Suorita mittaus sille määrätillä alueella.
Err02	Heijastettu signaali on liian heikko	Valitse sopivampi pinta.
Err03	Näyttöalueen ulkopuolella (suurin arvo: 99.999) esim. pinta-alan tai tilavuuden tulos on näyttöalueen ulkopuolella	Tarkasta, ovatko arvot ja vaiheet oikein.
Err04	Virhe Pythagoras-laskelmassa	Tarkasta, ovatko arvot ja vaiheet oikein.
Err05	Paristo heikko	Pane uudet paristot laitteeseen.
Err06	Työlämpötila-alueen ulkopuolella	suorita mittaus sille määrätillä työlämpötila-alueella.
Err07	Ympäristö liian valoisa	Tummenna kohdealue.

Pythagoras
Korkeusero

Mittaustaso

Pituuden mittaus

Jatkuvan mittauksen minimi / maksimi

Lisäys / Vähennys

PÄÄLLE / MITTAUS

- ▶ Päälle
- ▶ Mittaus
- ▶ Jatkuva mittaus (paina 2 sek.)
Min.-/max.-toiminto

YHTEENLASKU / VÄHENNYS

- ▶ Lisää arvo
- ▶ Liikkuminen muistissa

PINTA-ALA / TILAVUUS

- ▶ Pinta-ala (paina 1x)
- ▶ Tilavuus (paina 2x)
- ▶ Epäsuora pinta-alan mittaus (paina 3x / 4x)

KÄYNNISTYS

- ▶ Päälle
- ▶ Pois (paina 2 sek.)
- ▶ Takaisin

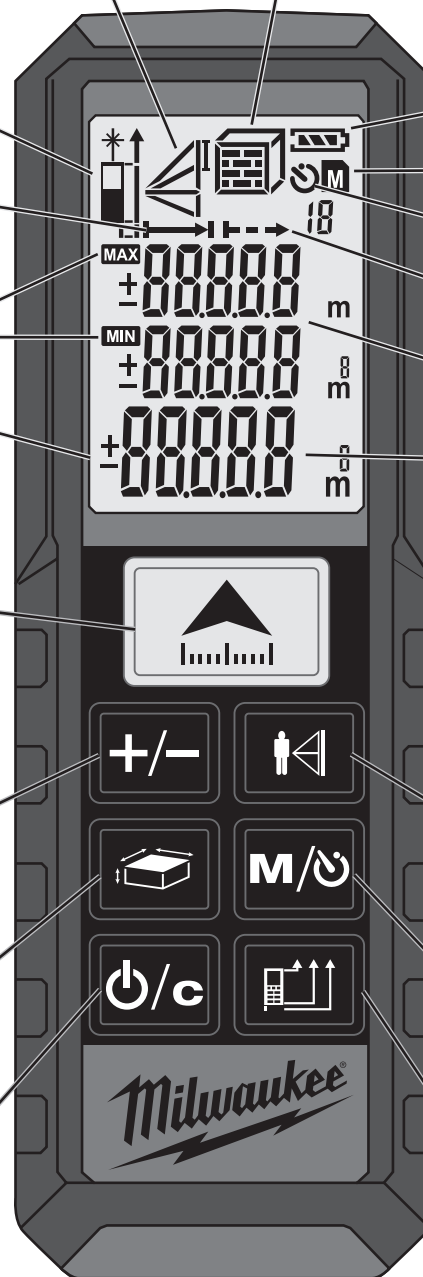

Pinta-ala / tilavuus
Epäsuora pinta-alan mittaus

Lataustila

Muisti

Ajastin

Jatkuva mittaus

Väliarvot

Kokonaisarvo

PYTHAGORAS

- ▶ Pythagoras 1 (paina 1x)
- ▶ Pythagoras 2 (paina 2x)
- ▶ Pythagoras 3 (paina 3x)

MUISTI

- ▶ Ajastin 3-15 sek. (paina 1x)
- ▶ Muisti 1-20 (paina 1x 2 sek.)
- ▶ Lue muistin tiedot (paina useamman kerran)

VAIHDA MITTAUSALUETTA

- ▶ Eteen
- ▶ Taakse
- ▶ Nurkkapuikko

PARISTOJEN VAIHTAMINEN

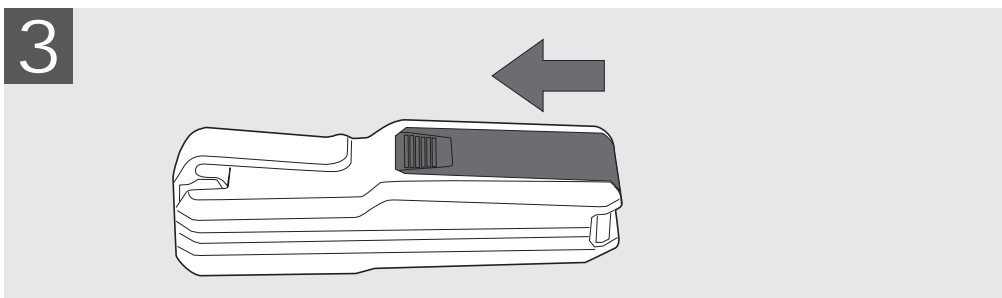
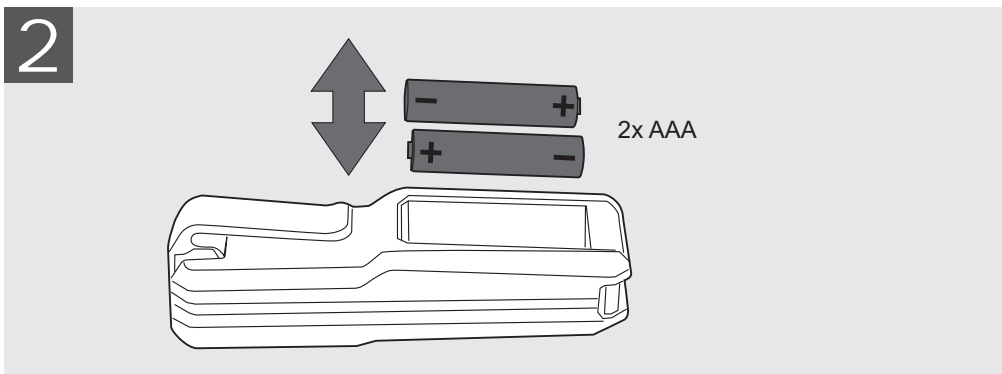
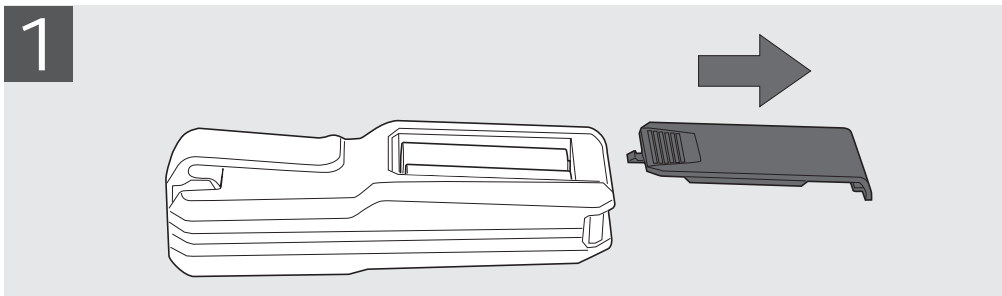
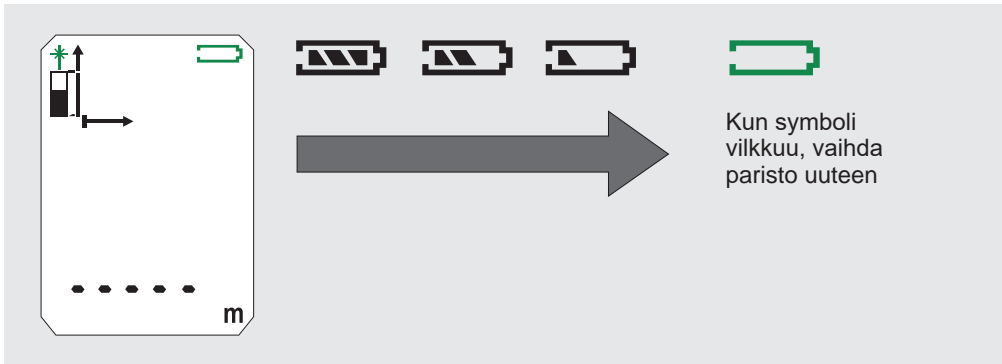

NURKKAPUIKKO

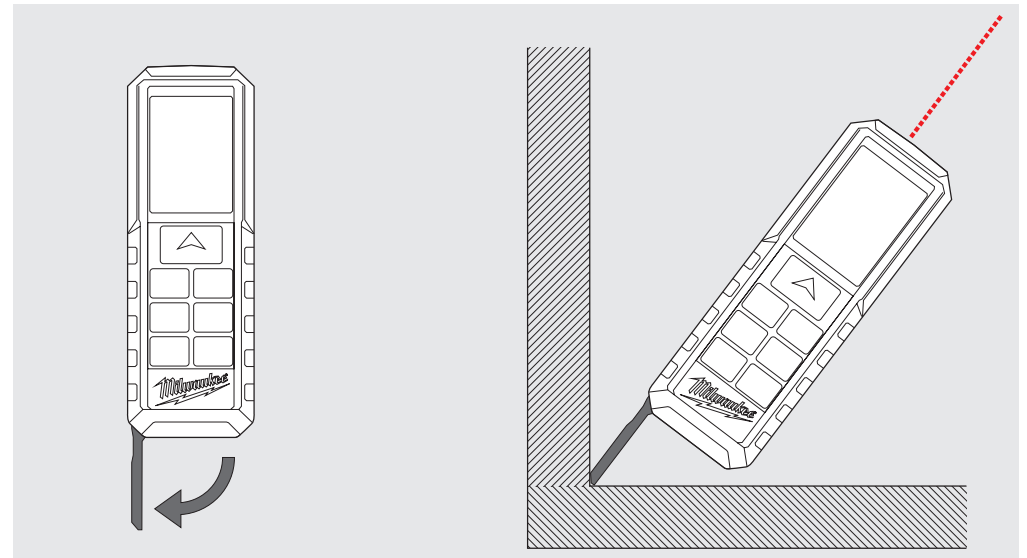

VYÖKANNATIN

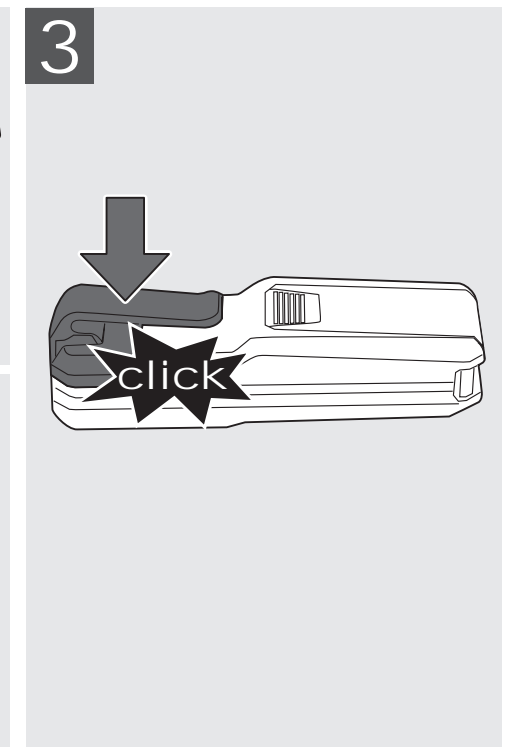
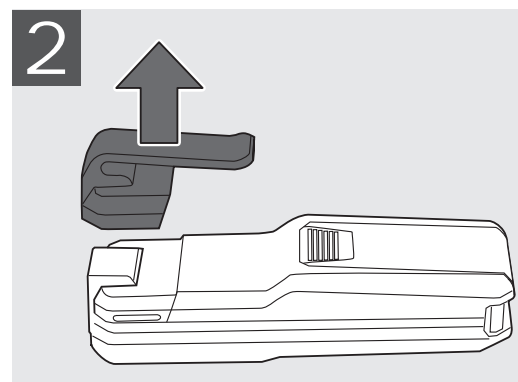
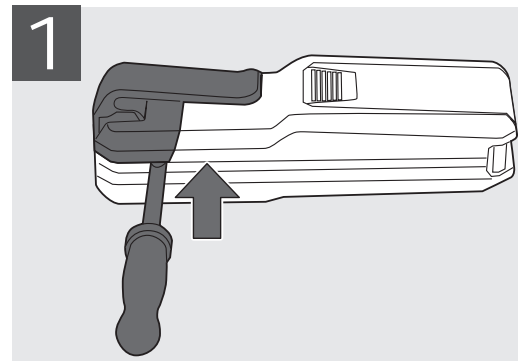

TOIMINTONÄPPÄIN, PYTHAGORAS, MITTAUSTASO

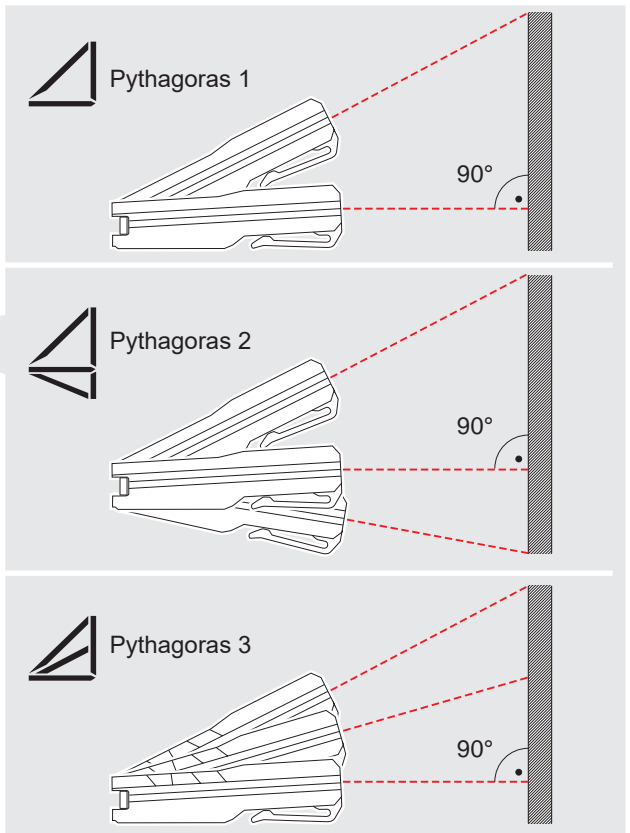
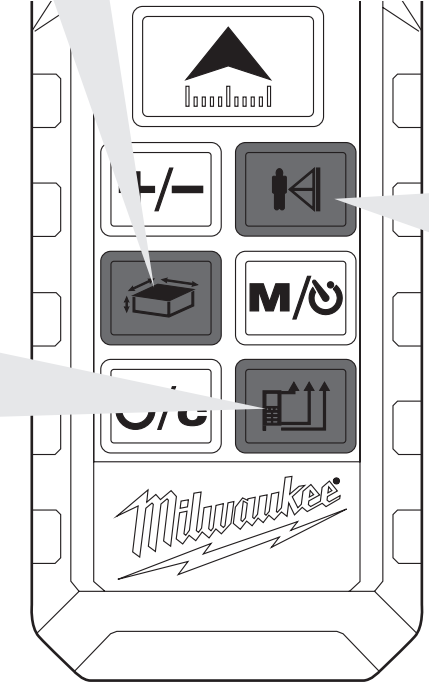
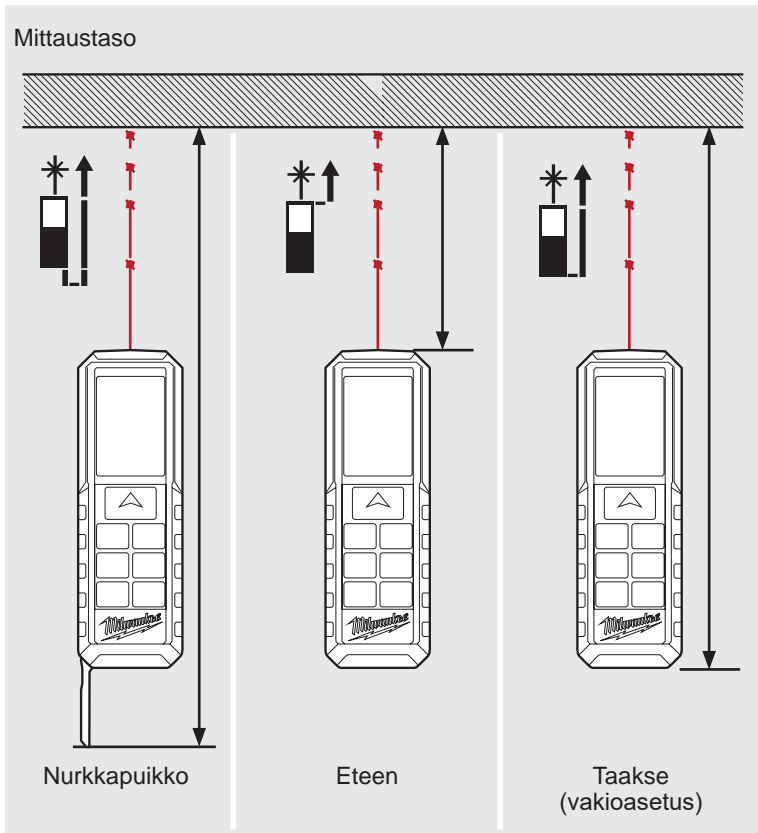
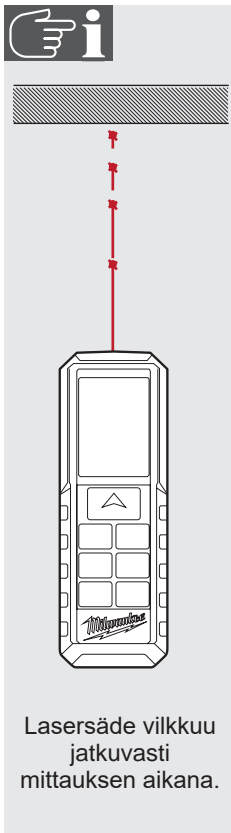
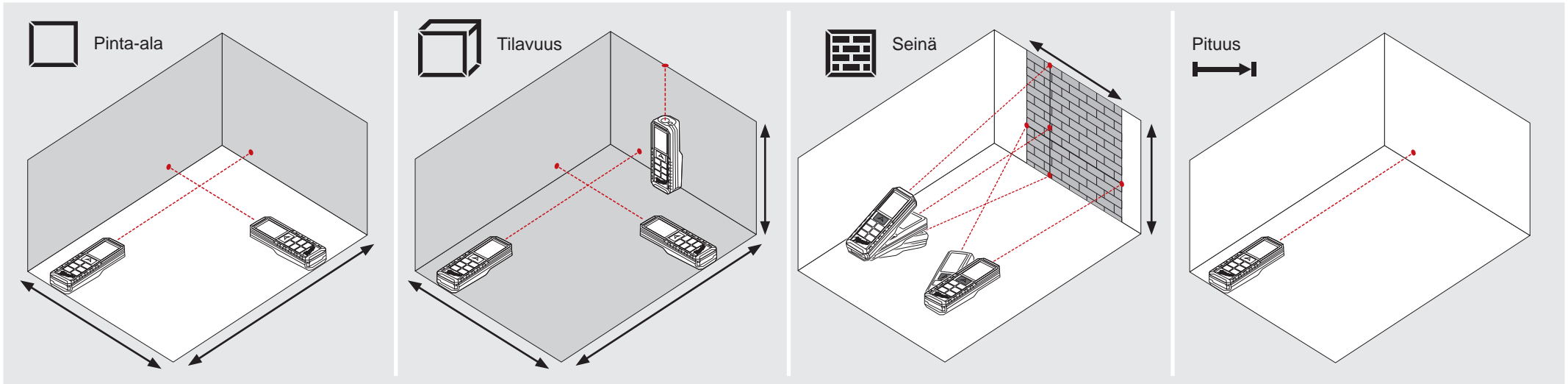

YKSINKERTAINEN PITUUSMITTAUS

0

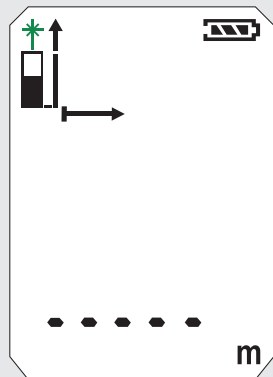

1

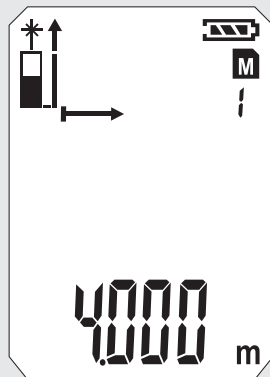

2

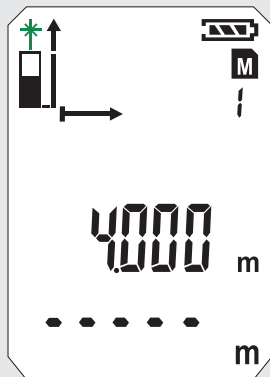

3

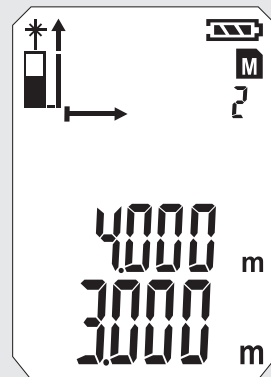

4

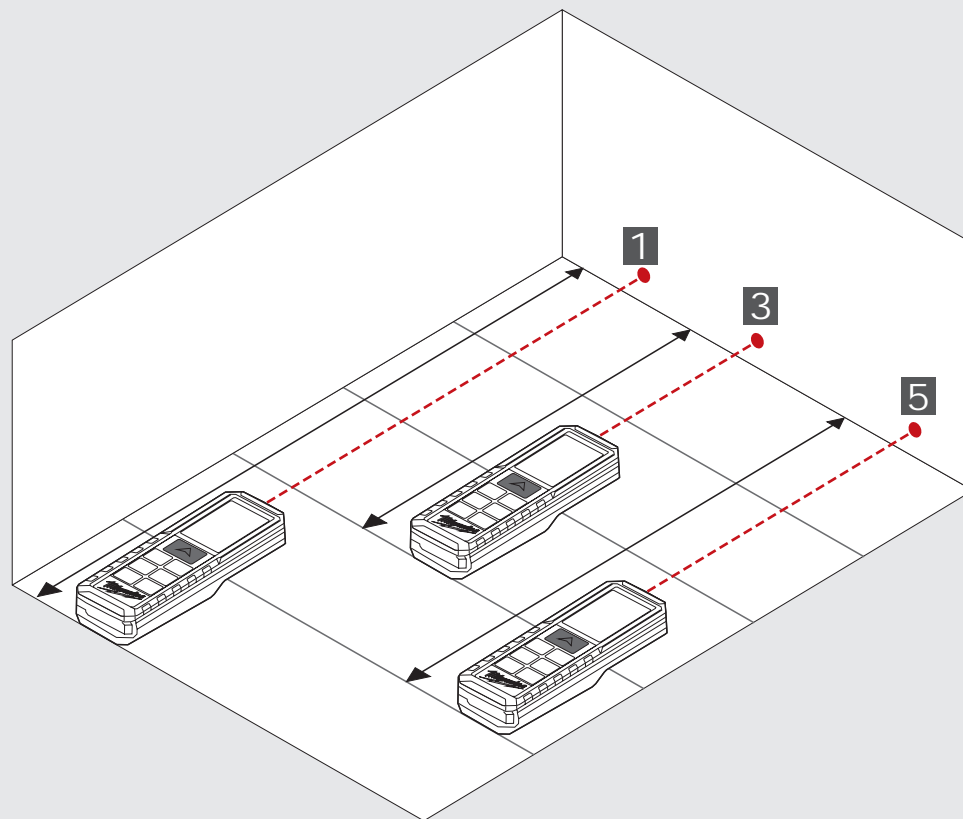
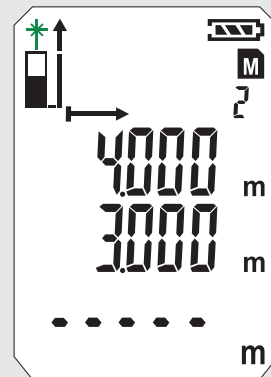

5

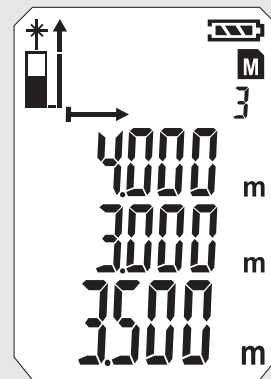

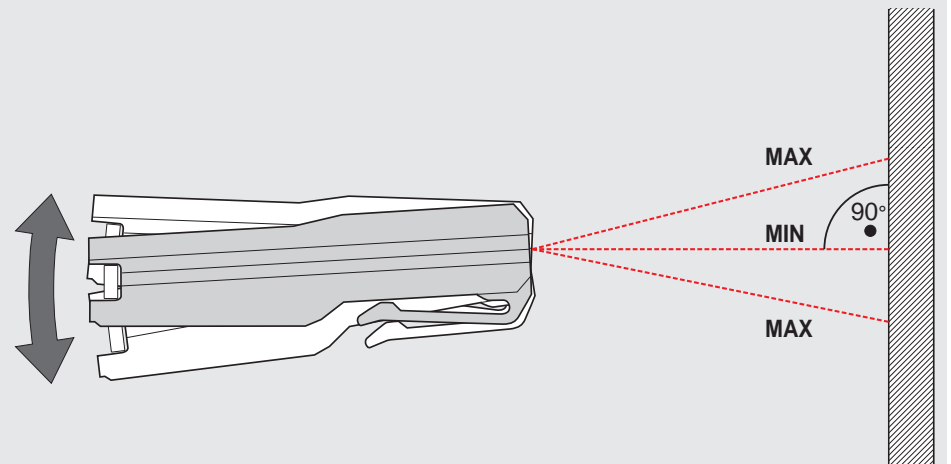
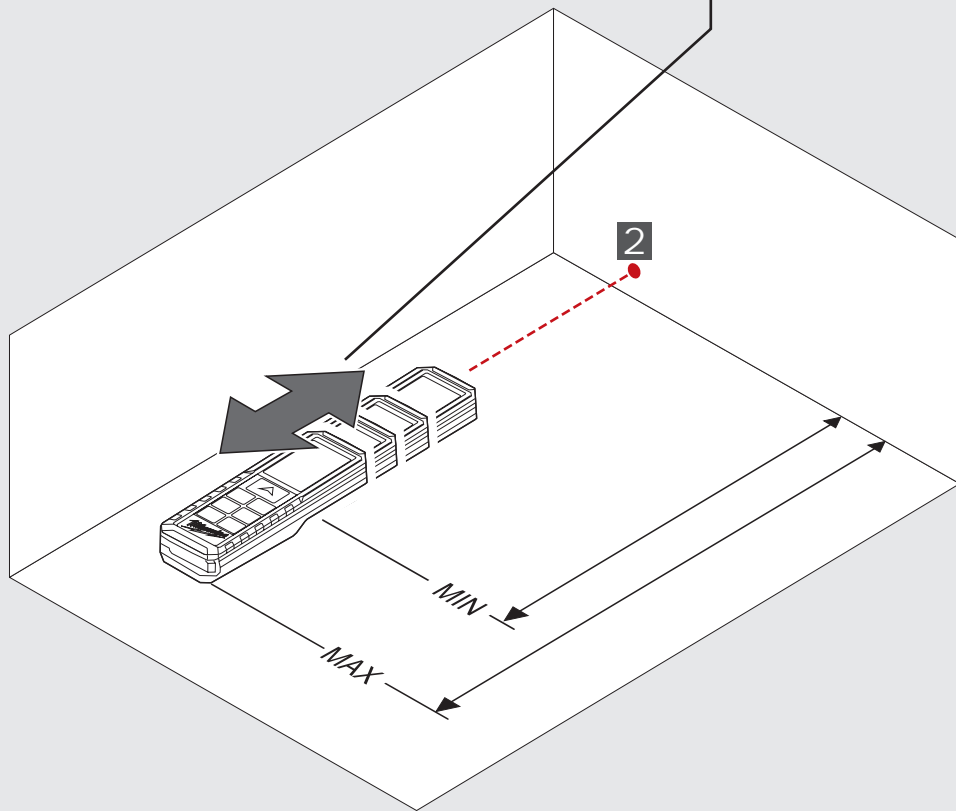
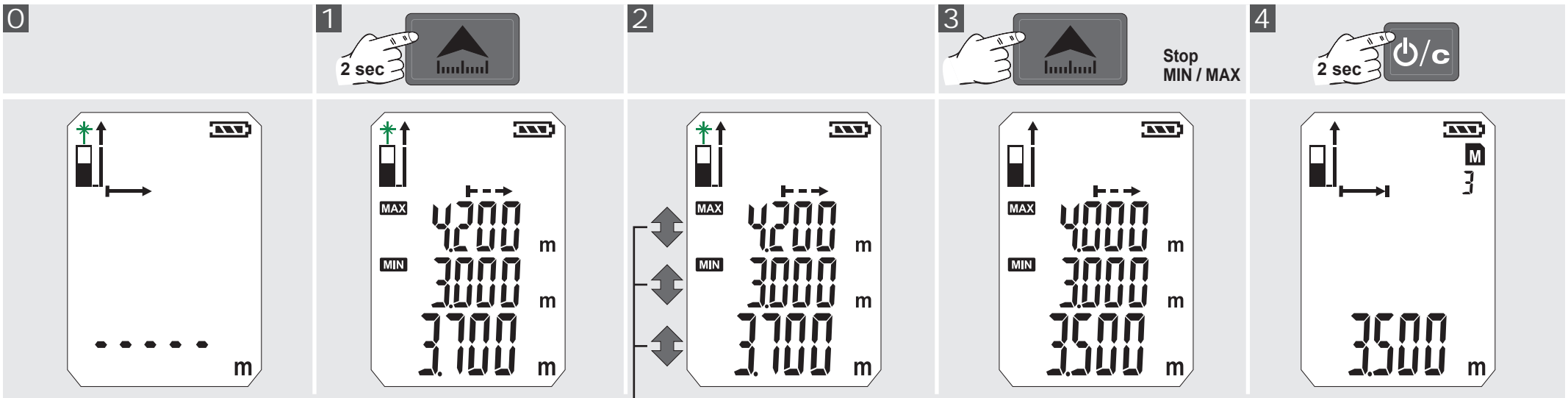

0

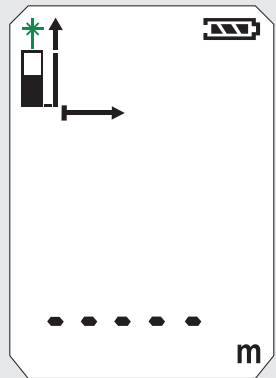

1

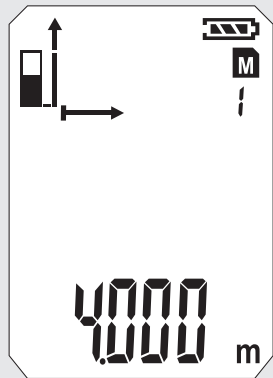

2

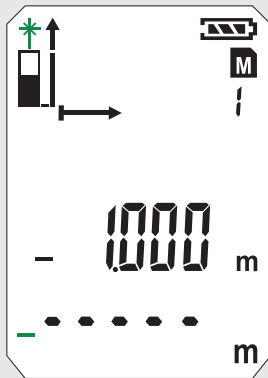

3

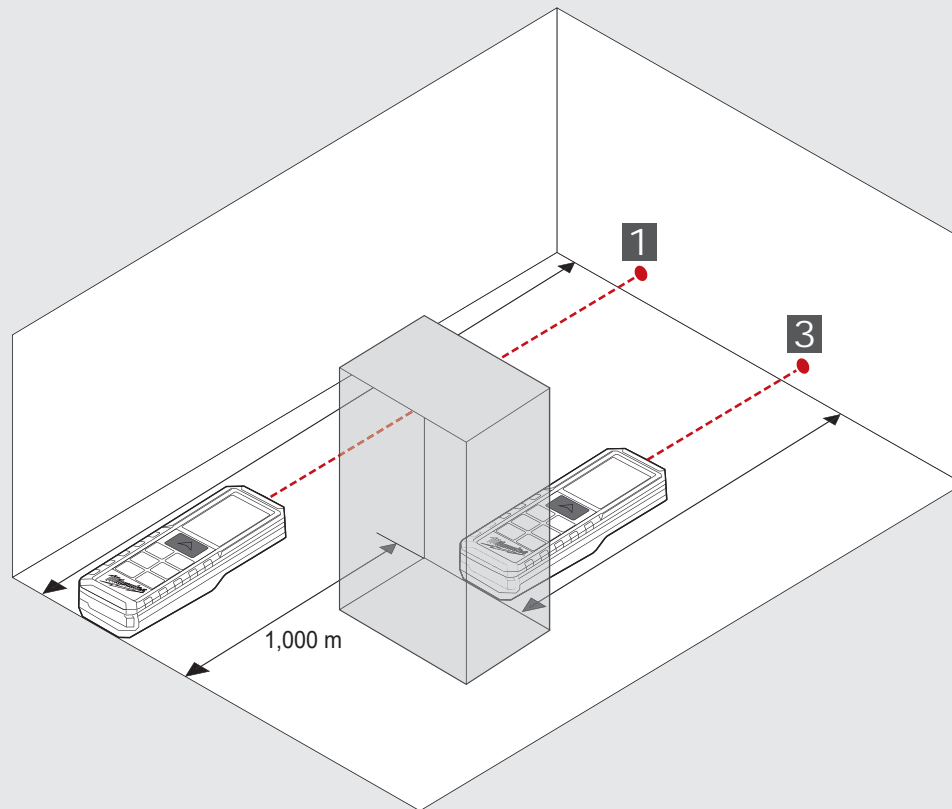
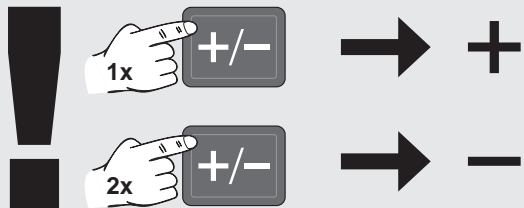
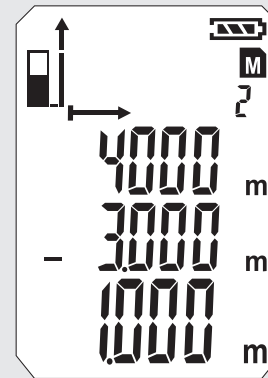

0



1



2

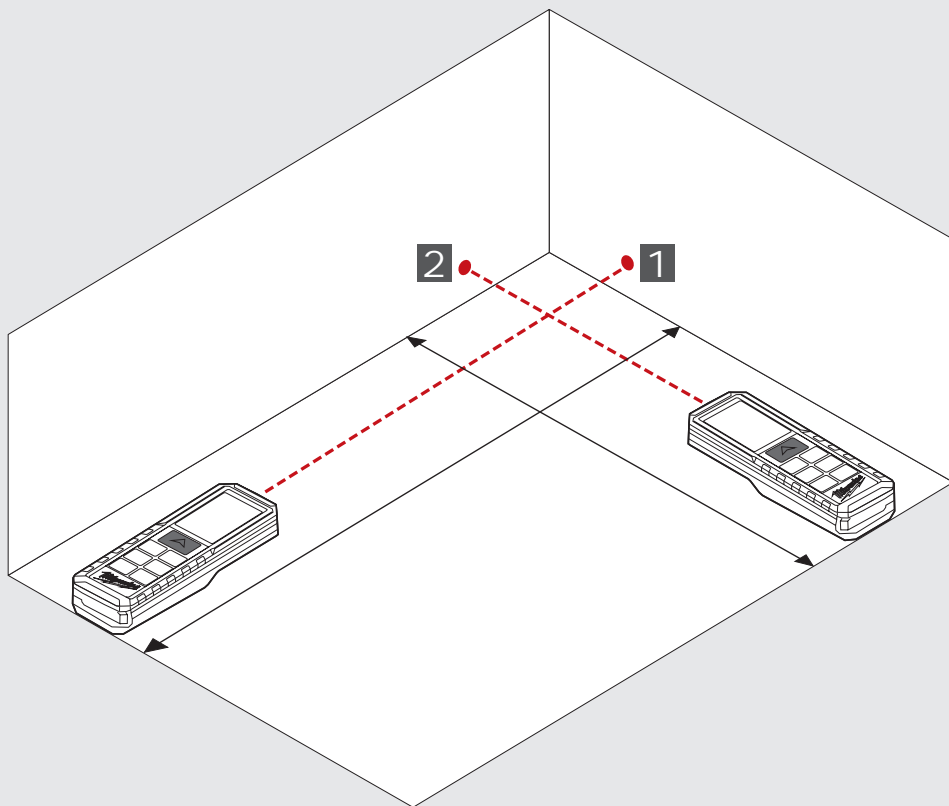
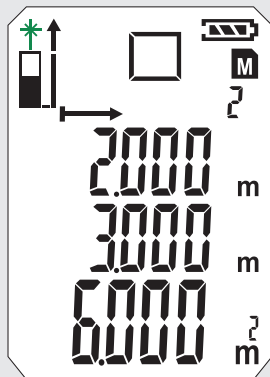
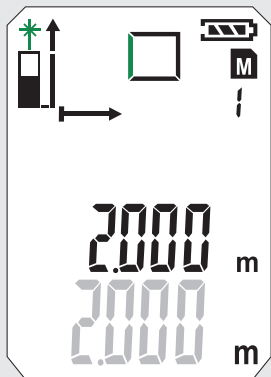
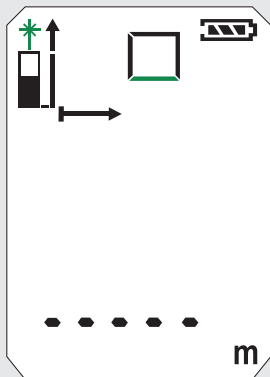

0



1



2



3

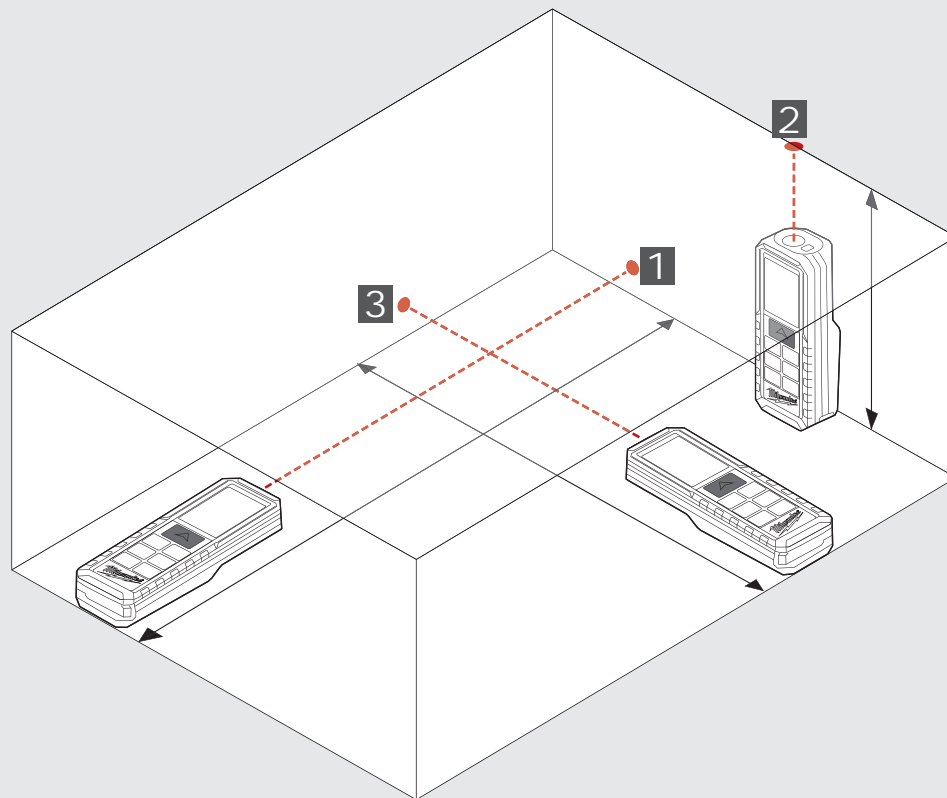
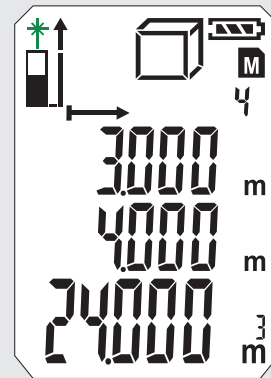
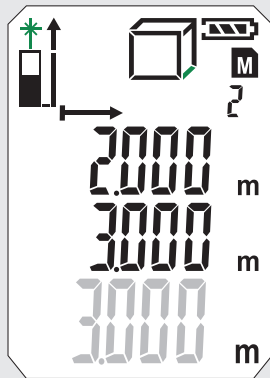
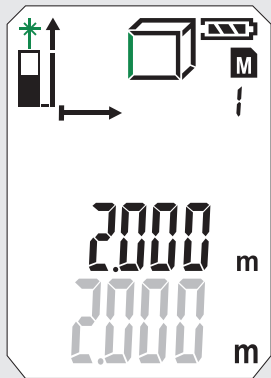
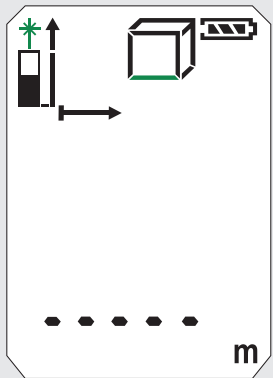
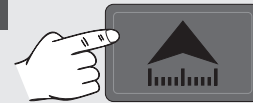

EPÄSUORA MITTAUS (PYTHAGORAS 1)

0



1



2

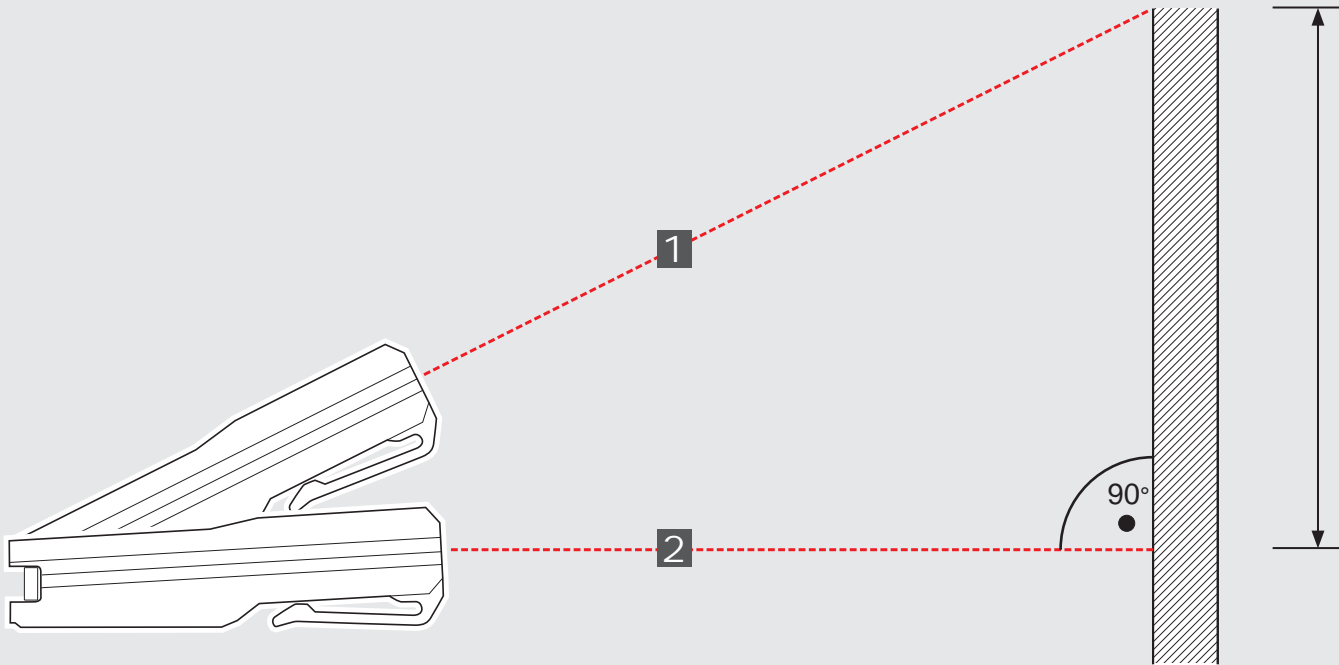
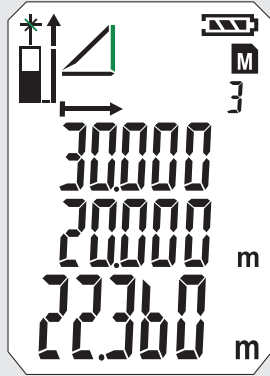
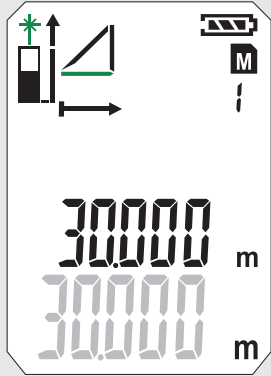
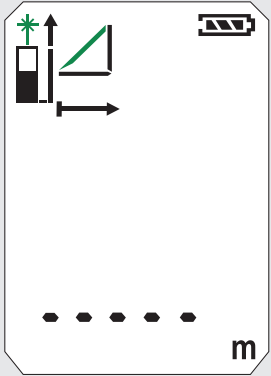

EPÄSUORA MITTAUS (PYTHAGORAS 2)

0

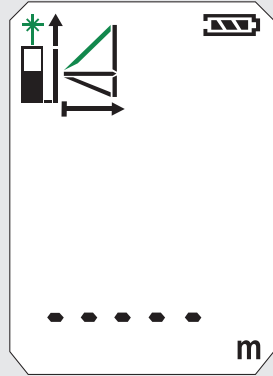

1

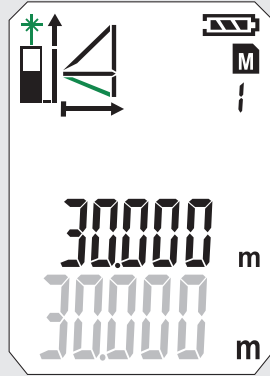

2

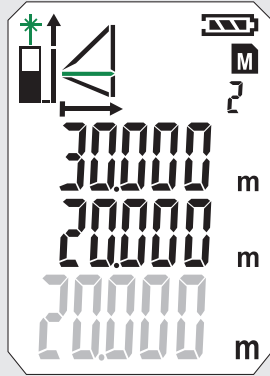

3

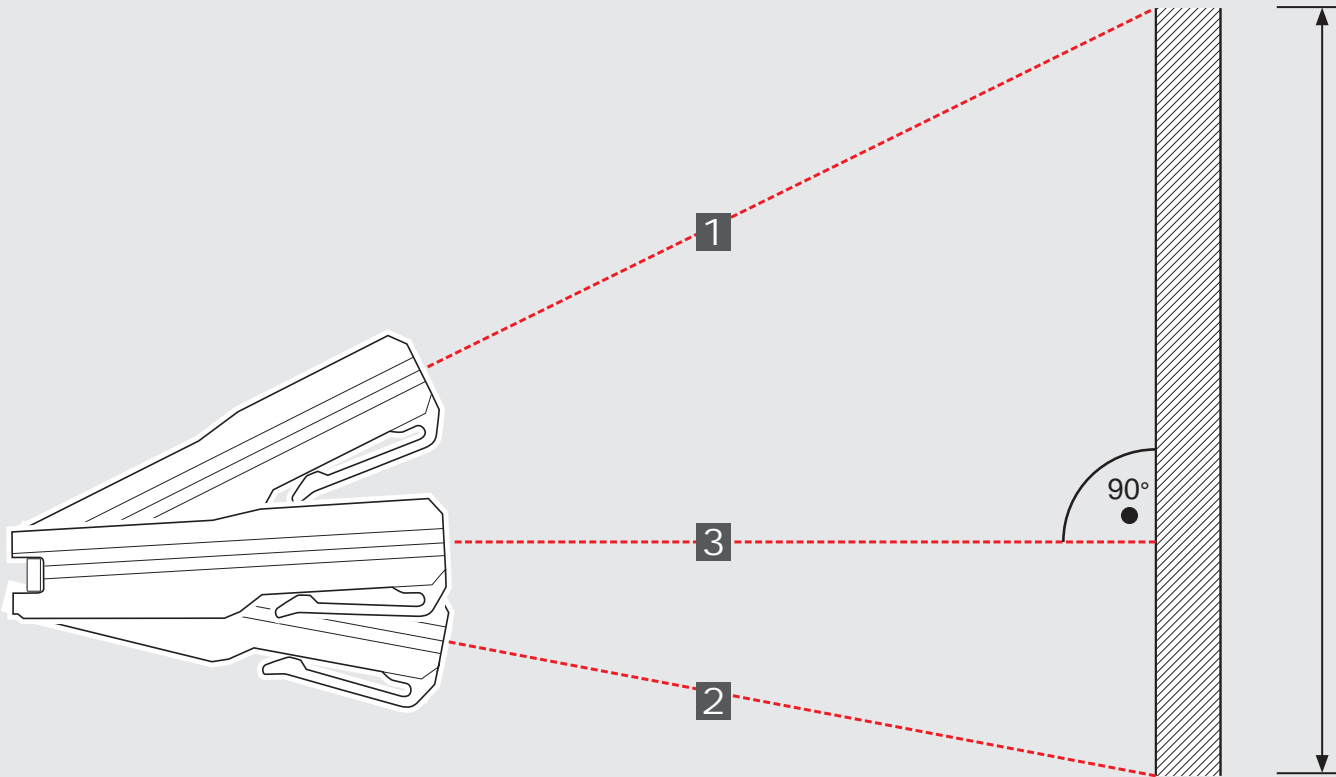
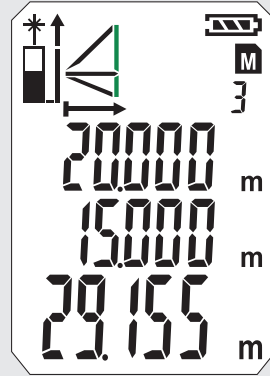



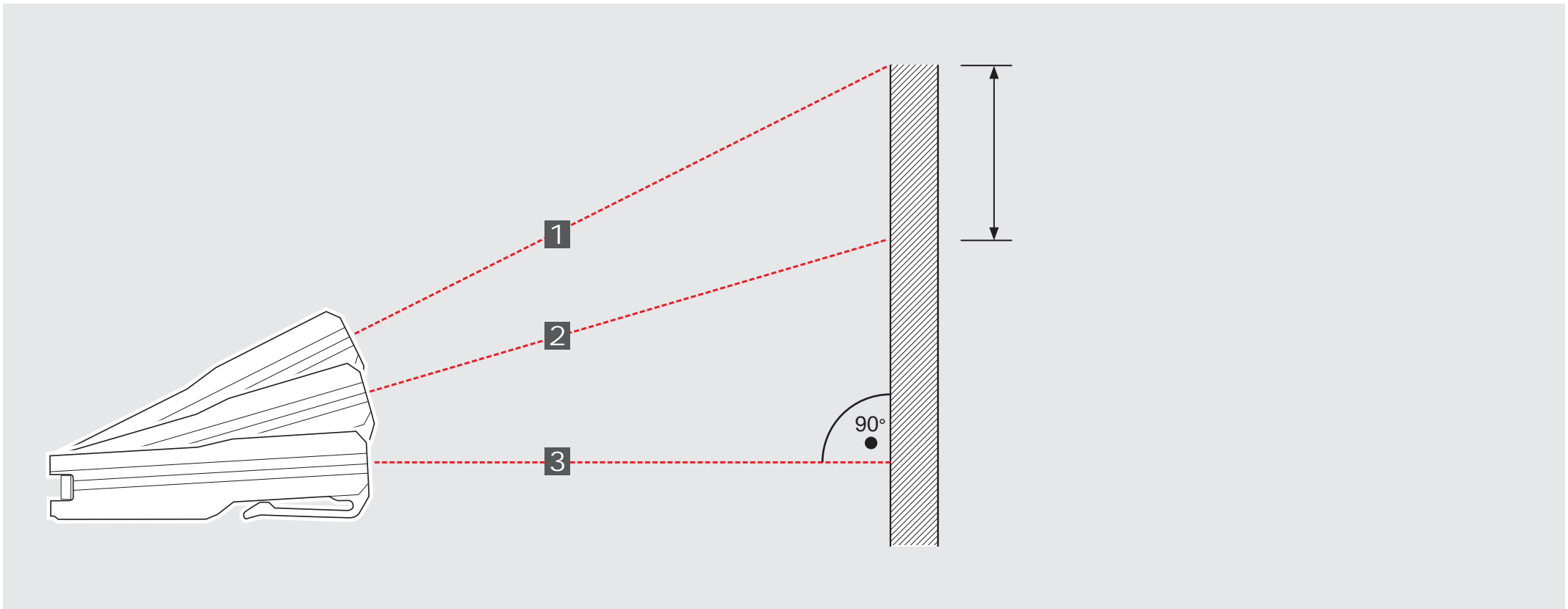

EPÄSUORA MITTAUS (PYTHAGORAS 3)

<p>1</p>	<p>2</p>	<p>3</p>	<p>4</p>

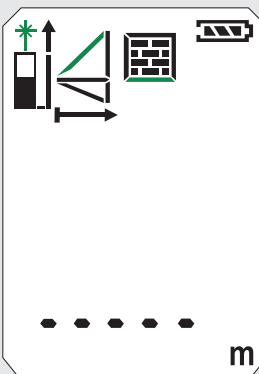
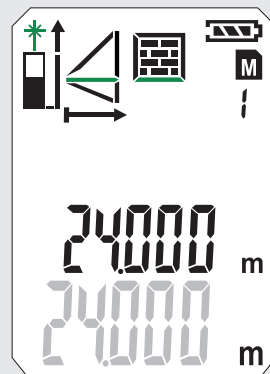
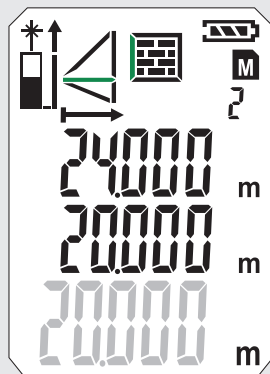
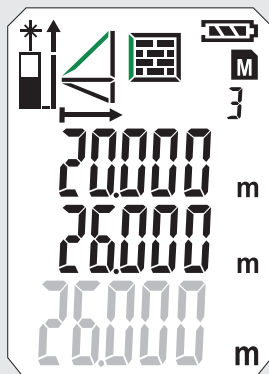
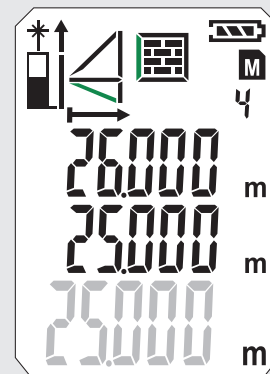

SEINÄN PINTA-ALAMITTAUS (MALLI 1)

<p>0</p> 	<p>1</p> 	<p>2</p> 	<p>3</p> 	<p>4</p> 
				

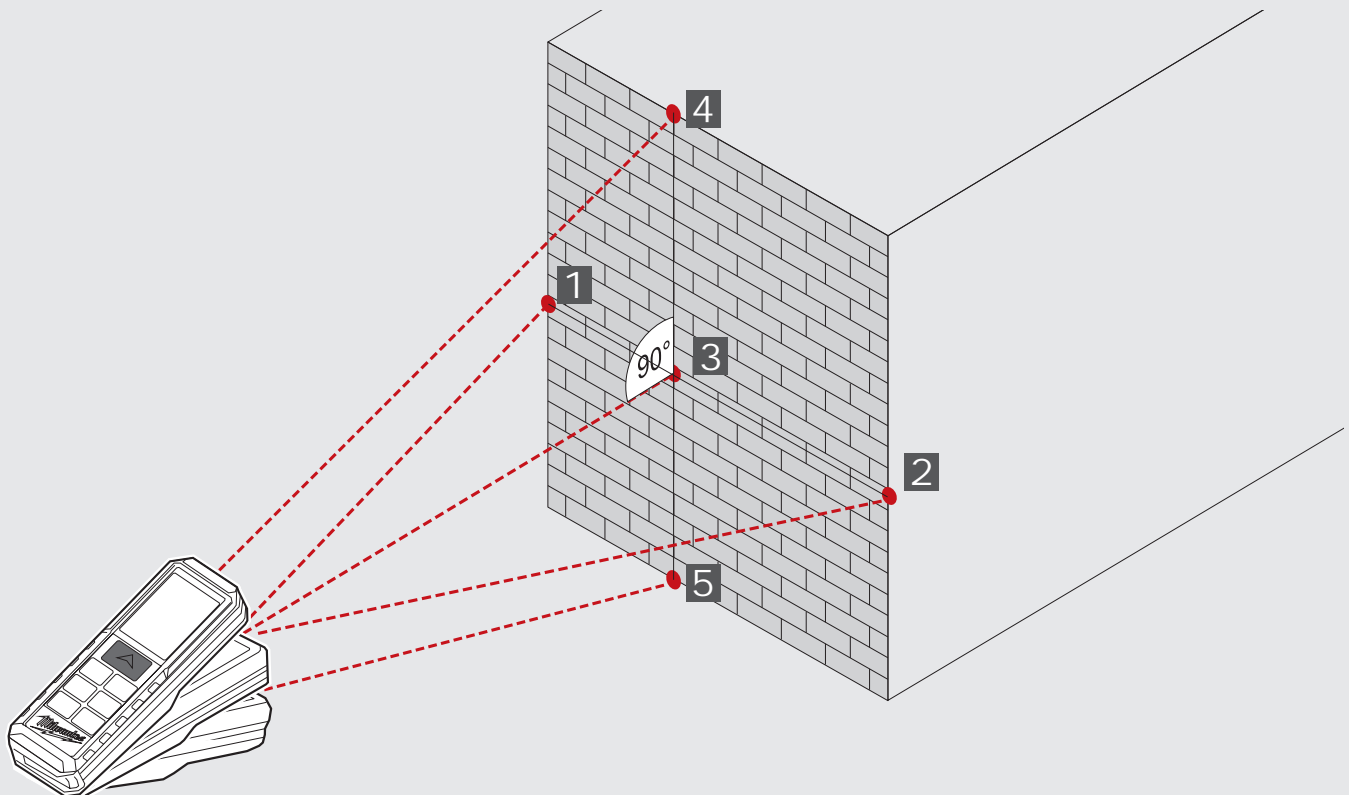



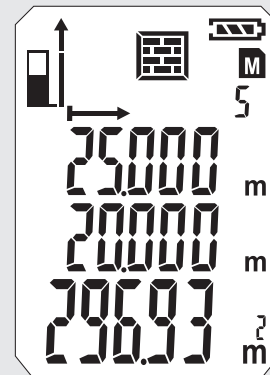

5



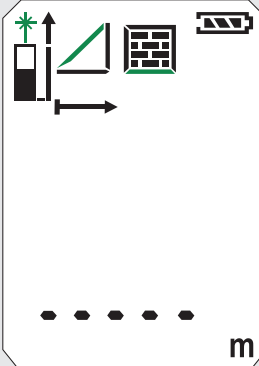
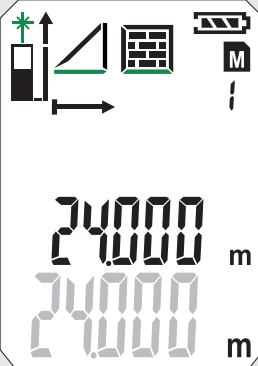
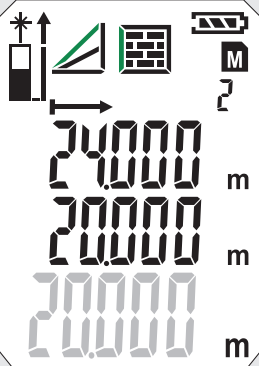
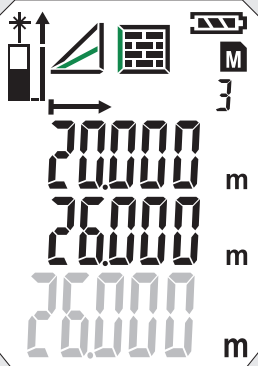
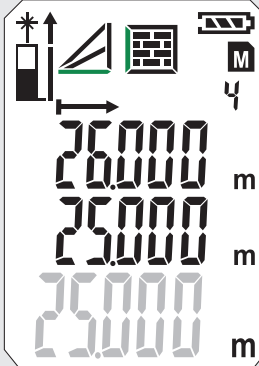

SEINÄN PINTA-ALAMITTAUS (MALLI 2)

<p>0</p> 	<p>1</p> 	<p>2</p> 	<p>3</p> 	<p>4</p> 
				

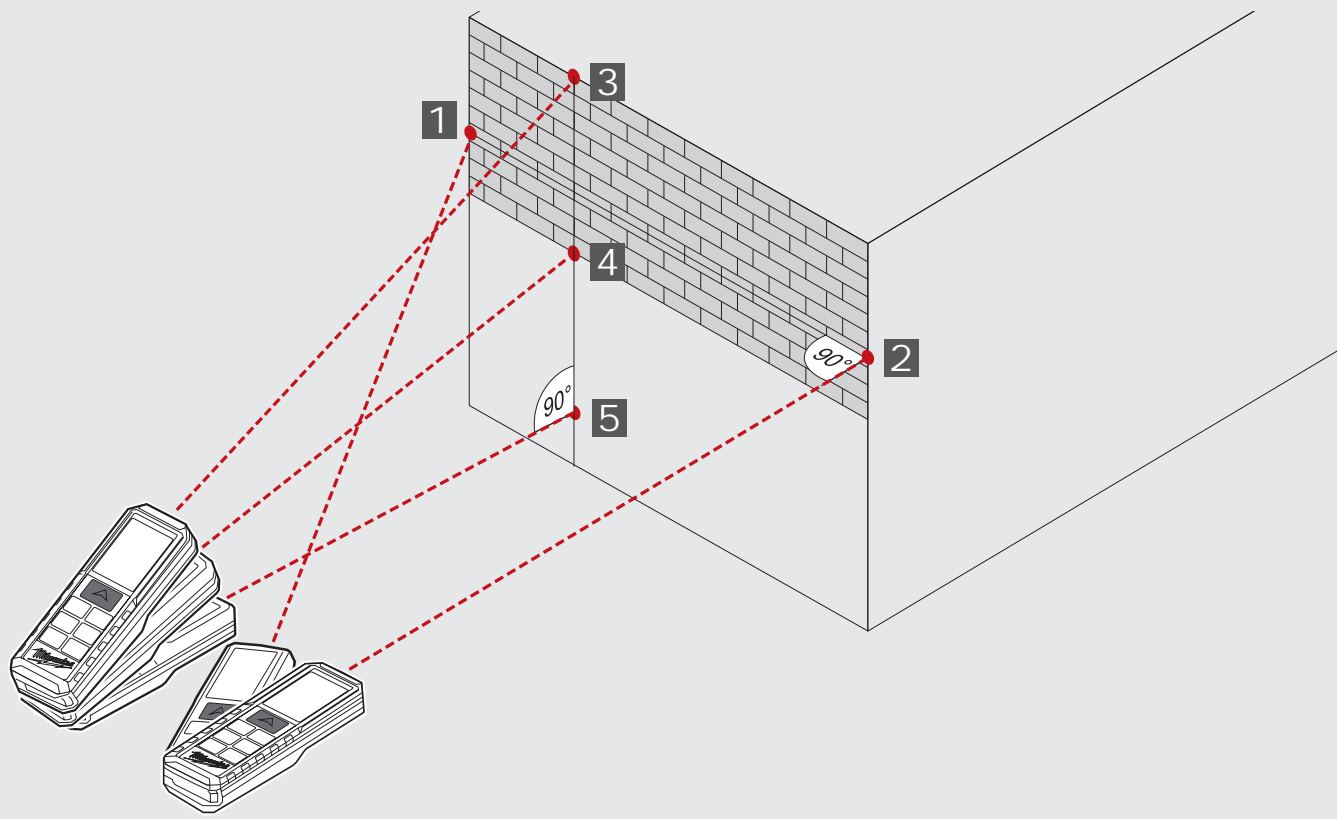

5



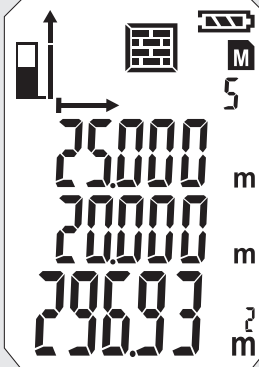

AJASTIN

Ajastimen avulla mittaus voidaan suorittaa viiveellä, esim. rakenneosan sijoittamiseksi mittaussäteeseen.

Paina  -näppäintä

- Symboli tulee näyttöön
- Painamalla  -näppäintä voit säätää ajastimen keston 3 ja 15 sekunnin välille.

Paina  näppäintä

- Sekunnit lasketaan alaspäin mittaukseen saakka.
- Arvossa 0 mittaus laukaistaan.

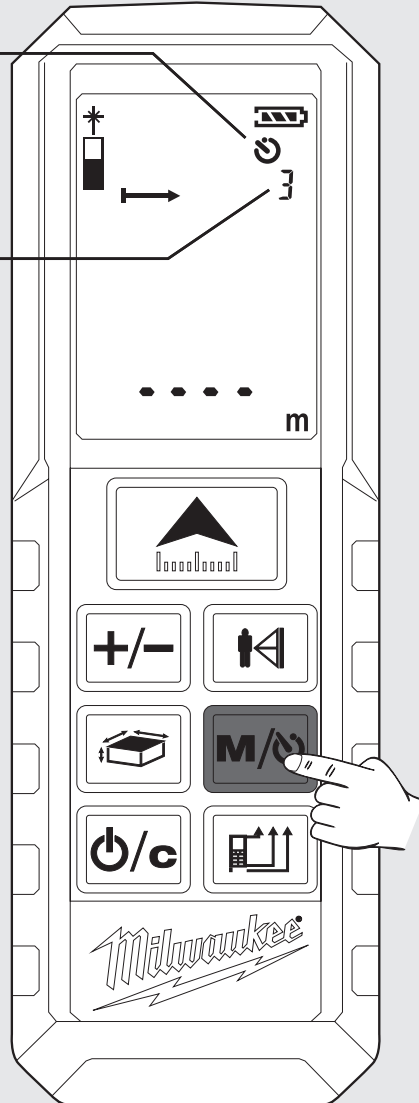

MUISTI

Mittausarvot tallennetaan automaattisesti jatkuvasti muistiin.

Tallennetut arvot saadaan näyttöön painamalla  -näppäintä.

Paina  -näppäintä 2 sek. ajan

- Näyttöön tulee symboli ja muistipaikka.
- Siihen kuuluva mittausarvo tulee näyttöön.
- Tallennettu arvo tulee näyttöön päiville.
- Lue tallennetut tiedot painamalla useamman kerran näppäintä .

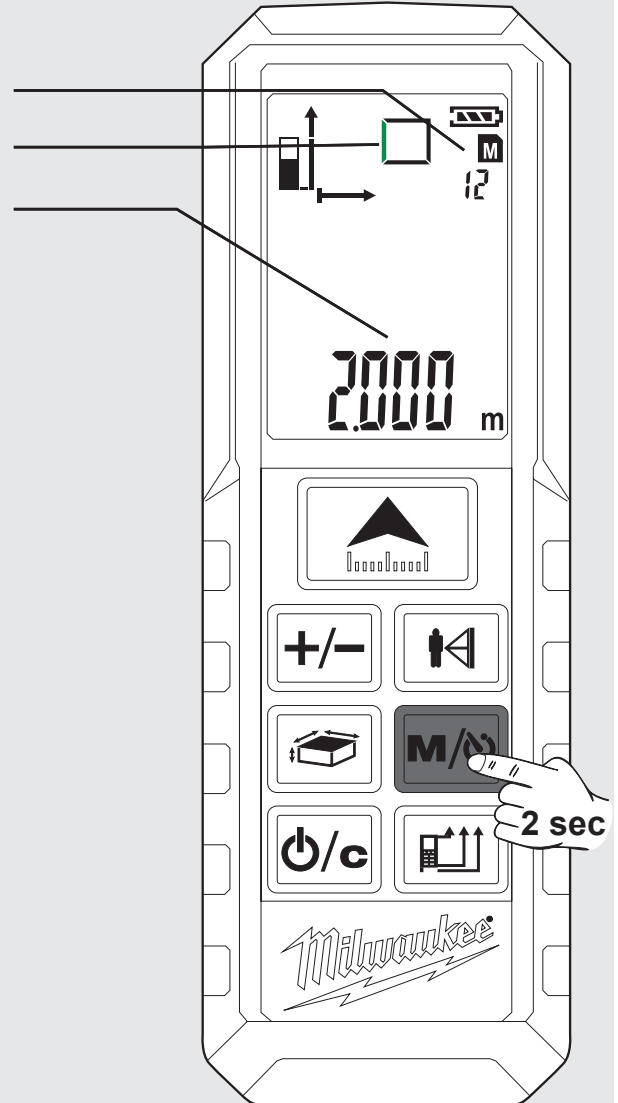



PERUSLUONTAINEN TOIMINTATAPA PINTA-ALAMITTAUKSEN (1) ESIMERKILLÄ NÄYTETTYNÄ

1 Päällekytkentä

Paina  -näppäintä.
⚠ Huomio! Lasersäde on päällä!
 Älä kohdista sitä ihmisiin!

2 Valitse mittaustaso

Vakioasetus päällekytkennän jälkeen: takana
 Paina  1x -> nurkkaupikko
 Paina  2x -> edessä
 Paina  3x -> takana

3 Valitse toimento

Käynnistämisen jälkeen laite on aina asetettu pituusmittaukselle.
 Paina  1x -> pinta-alamittaus

4 Mittaa pituus

Kohdista laite ja paina  -näppäintä

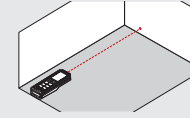

5 Mittaa leveys

Kohdista laite ja paina  -näppäintä

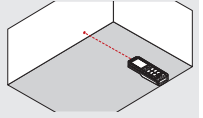

Lasersymboli vilkkuu (vilkkuminen esitetään vihreänä).

Näyttöön tulee symboli

- Näyttöön tulee symboli
 - Mittaus suure vilkkuu (vilkkuminen esitetään vihreänä).

- Mittausarvo tulee lyhyesti näkyviin päärivillä
 - Mittausarvo siirtyä 1 sekunnin jälkeen sen yläpuolella olevalle riville
 - Mittausarvo tallennetaan muistiin jatkuvalla numeroinnilla.
 - Toinen mittaus suure vilkkuu. Laite on valmis toisen arvon mittaamiseen.

- Mittausarvo tulee lyhyesti näkyviin päärivillä
 - Mittausarvo siirtyä 1 sekunnin jälkeen sen yläpuolella olevalle riville
 - Mittausarvo tallennetaan muistiin jatkuvalla numeroinnilla.
 - Tulos näytetään päärivillä ja tallennetaan muistiin jatkuvalla numeroinnilla.

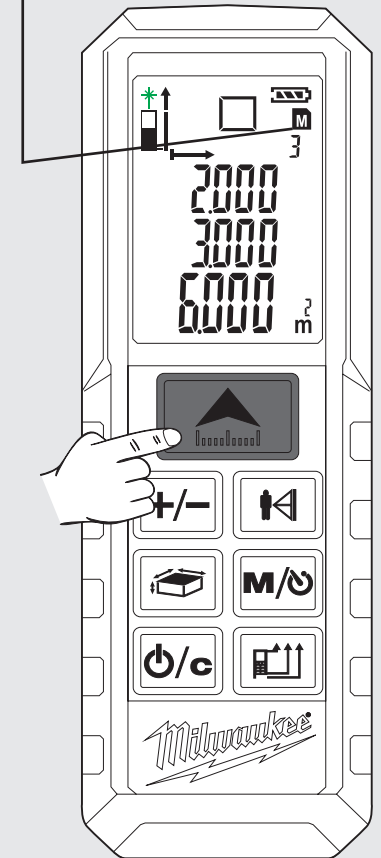
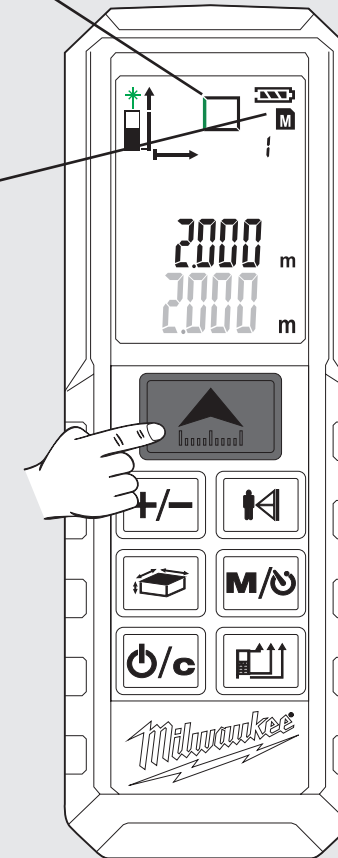
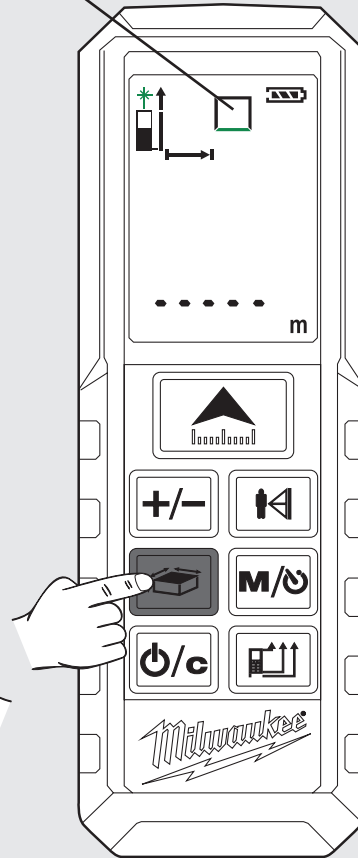
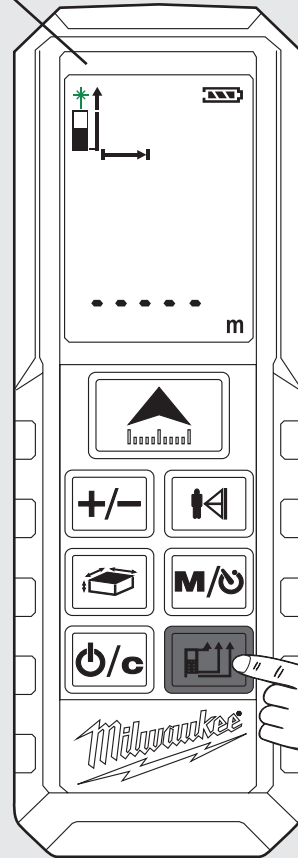
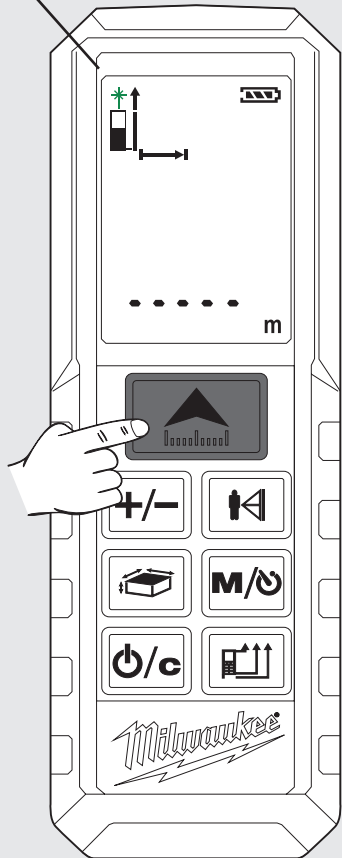

6 Hae tallennetut arvot näyttöön

Paina **M/0** -näppäintä 2 sek. ajan.
Paina näppäintä **M/0** useamman kerran.

7 Poistu muistista

Paina **0/c** -näppäintä

8 Sammuttaminen

Paina **0/c** -näppäintä 2 sek. ajan (sitä ennen täytyy poistua muistista).

- Tallennetut arvot tulevat näyttöön pääriville.
- Siihen kuuluva symboli tulee näyttöön ja mittaussuure vilkkuu (vilkuminen esitetään vihreänä).

- Laite sammuu.
- Jos 3 minuutin aikana ei paineta mitään näppäintä, niin laite sammuu automaattisesti.

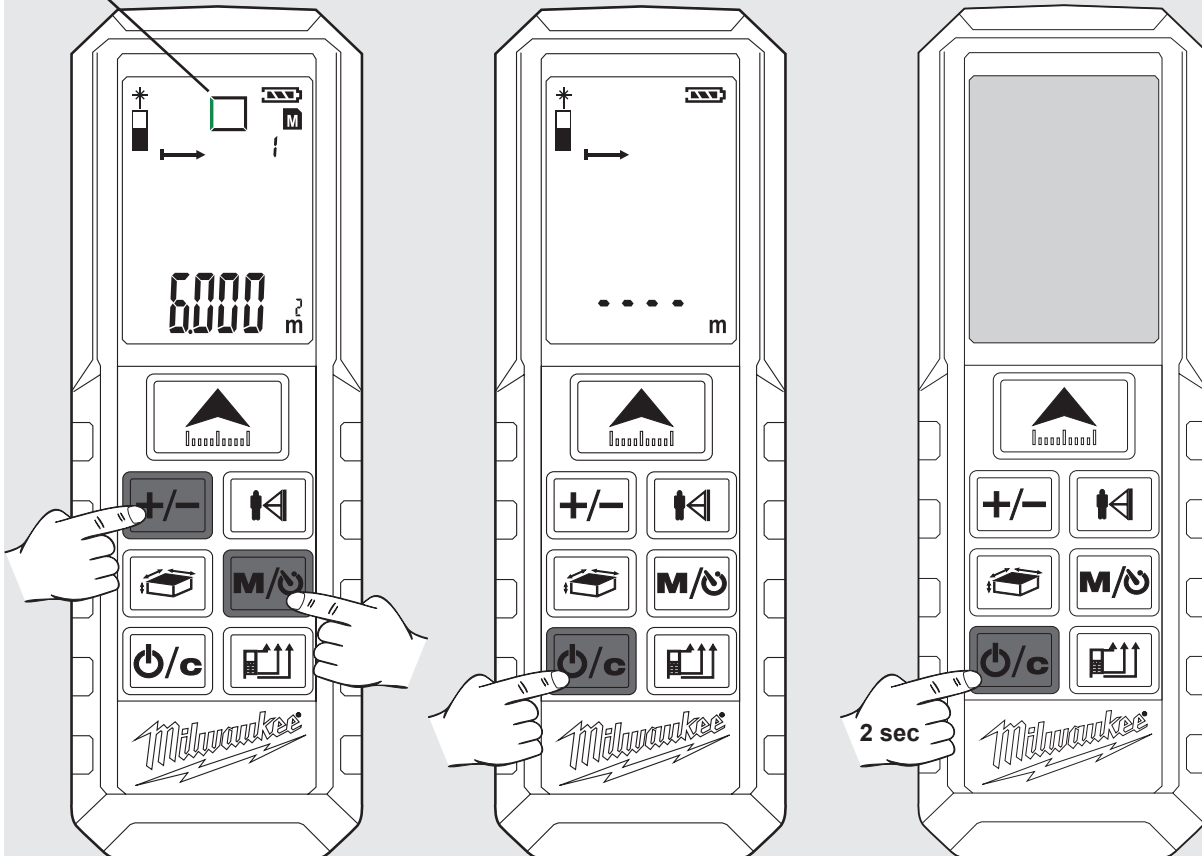

ΠΕΡΙΕΧΟΜΕΝΑ

Σημαντικές οδηγίες ασφαλείας	1
Τεχνικά στοιχεία	2
Χρήση σύμφωνα με το σκοπό προορισμού.....	2
Πίνακας κωδικών σφαλμάτων	2
Σύνοψη	3
Αλλαγή μπαταρίας	4
Ακίδα γωνίας	4
Κλιπ ζώνης	4
Πλήκτρο λειτουργίας, Πυθαγόρας, επίπεδο μέτρησης	5
Απλή μέτρηση απόστασης	6
Συνεχής μέτρηση / Μέτρηση μέγιστου-ελάχιστου	7
Μέτρηση με πρόσθεση / αφαίρεση.....	8
Μέτρηση επιφάνειας.....	9
Μέτρηση όγκου.....	10
Έμμεση μέτρηση (Πυθαγόρας 1).....	11
Έμμεση μέτρηση (Πυθαγόρας 2).....	12
Έμμεση μέτρηση (Πυθαγόρας 3).....	13
Μέτρηση επιφάνειας τοίχου (διαδικασία 1).....	14
Μέτρηση επιφάνειας τοίχου (διαδικασία 2).....	15
Χρονοδιακόπτης	16
Μνήμη.....	16
Περιγραφή της βασικής διαδικασίας μέτρησης χρησιμοποιώντας το παράδειγμα μιας μέτρησης επιφάνειας (1).....	17
Περιγραφή της βασικής διαδικασίας μέτρησης χρησιμοποιώντας το παράδειγμα μιας μέτρησης επιφάνειας (2).....	18

ΣΗΜΑΝΤΙΚΕΣ ΟΔΗΓΙΕΣ ΑΣΦΑΛΕΙΑΣ



Μη χρησιμοποιήσετε το προϊόν χωρίς πρώτα να διαβάσετε τις Οδηγίες ασφαλείας και το Εγχειρίδιο χρήσης στο συνοδευτικό CD.

Κατηγορία Laser

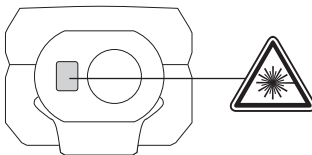

ΠΡΟΕΙΔΟΠΟΙΗΣΗ:

Πρόκειται για ένα προϊόν λέιζερ Κλάσης 2 σύμφωνα με το πρότυπο EN60825-1:2014.



λ 650 nm P<1 mW

Αποφύγετε την απευθείας έκθεση των ματιών σας στην ακτίνα laser. Κάτι τέτοιο μπορεί να προκαλέσει προσωρινή θάμβωση.

Μην κοιτάζετε απευθείας μέσα στην ακτίνα λέιζερ και μην τη στρέψετε χωρίς λόγο προς άλλα άτομα.

Μην "τυφλώνετε" άλλα άτομα.

Προειδοποίηση:

Μην χρησιμοποιείτε την συσκευή laser κοντά σε παιδιά και μην επιτρέπετε σε παιδιά να την χρησιμοποιήσουν.

Προσοχή! Η ακτίνα laser μπορεί να αντανάκλασθεί πάνω σε μια ανακλώσα επιφάνεια πίσω στον χειριστή ή σε άλλα πρόσωπα.

ηρείτε απόσταση ασφαλείας από τα κινούμενα μέρη.

Πραγματοποιείτε τακτικές δοκιμαστικές μετρήσεις. Ιδίως πριν, στη διάρκεια και μετά από σημαντικές μετρήσεις.

Προσέχετε για εσφαλμένες μετρήσεις εάν το προϊόν είναι ελαττωματικό, εάν έχει πέσει κάτω, εάν έχει τύχει κακής μεταχείρισης ή εάν έχει τροποποιηθεί.

Προσοχή: Η χρήση στοιχείων ελέγχου και ρυθμίσεως ή η εκτέλεση διεργασιών άλλων από αυτές που ορίζονται στο εγχειρίδιο χρήσης μπορεί να οδηγήσουν σε επικίνδυνη έκθεση σε ακτινοβολία.

Η συσκευή μέτρησης αποστάσεως με ακτίνα laser έχει συγκεκριμένη περιοχή μέτρησης. (Βλέπε παράρτημα "Τεχνικά χαρακτηριστικά"). Μετρήσεις μικρότερων ή μεγαλύτερων αποστάσεων από την περιοχή μέτρησης έχουν ως αποτέλεσμα απώλεια ακρίβειας. Η λειτουργία κάτω από δυσμενείς συνθήκες όπως πολύ κρύο ή ζέστη, έντονη ηλιοφάνεια, βροχή, χιόνι, ομίχλη ή άλλες συνθήκες που δυσχεραίνουν την ορατότητα έχουν ως αποτέλεσμα μετρήσεις μειωμένης ακρίβειας.

Αν μεταφέρετε την συσκευή μέτρησης αποστάσεως με ακτίνα laser από ένα θερμό περιβάλλον σε ένα ψυχρό (ή το αντίθετο), περιμένετε μέχρι να προσαρμοστεί η θερμοκρασία της συσκευής στις καινούριες συνθήκες.

Φυλάξτε την συσκευή μέτρησης αποστάσεως με ακτίνα laser πάντα σε κλειστός χώρους και προφυλάξτε την από κραδασμούς, δονήσεις ή ακραίες θερμοκρασίες.

Προφυλάξτε την συσκευή μέτρησης αποστάσεως με ακτίνα laser από σκόνη, υγρασία και υψηλή ατμοσφαιρική υγρασία. Κάτι τέτοιο μπορεί να καταστρέψει εξαρτήματα στο εσωτερικό της ή να επηρεάσει την ακρίβεια μέτρησης.

Μην χρησιμοποιείτε δραστικά απορρυπαντικά ή διαλυτικά. Καθαρίστε την συσκευή μόνο με ένα καθαρό και μαλακό πανί.

Αποφύγετε δυνατά χτυπήματα ή πτώση της συσκευής μέτρησης αποστάσεως με ακτίνα laser. Η ακρίβεια μέτρησης πρέπει να ελεγχθεί μετά από μια πτώση ή μετά από άλλες μηχανικές καταπονήσεις.

Απαιτούμενες εργασίες επισκευής στην συσκευή laser επιτρέπεται να διενεργούνται μόνο από εξουσιοδοτημένο ειδικευμένο προσωπικό.

Μη χρησιμοποιείτε το προϊόν σε περιοχές που ενέχουν κίνδυνο έκρηξης ή σε επιθετικά περιβάλλοντα.

Χρησιμοποιείτε μόνο φορτιστές που συνιστώνται από τον κατασκευαστή για να φορτίσετε τις μπαταρίες.



Απόβλητα ηλεκτρικών στηλών και ηλεκτρικού και ηλεκτρονικού εξοπλισμού δεν επιτρέπεται να απορρίπτονται μαζί με τα οικιακά απορρίμματα. Απόβλητα ηλεκτρικών στηλών και ηλεκτρικού και ηλεκτρονικού εξοπλισμού πρέπει να συλλέγονται και να απορρίπτονται ξεχωριστά.

Πριν την απόρριψη να αφαιρείτε ηλεκτρικές στήλες, συσσωρευτές και λαμπτήρες από τον εξοπλισμό.

Ενημερωθείτε από τις τοπικές υπηρεσίες ή από ειδικευμένους εμπόρους σχετικά με κέντρα ανακύκλωσης και συλλογής απορριμμάτων.

Ανάλογα με τους τοπικούς κανονισμούς μπορεί να είναι οι έμποροι λιανικής πώλησης υποχρεωμένοι, να παίρνουν πίσω απόβλητα ηλεκτρικών στηλών και ηλεκτρικού και ηλεκτρονικού εξοπλισμού δωρεάν. Συμβάλλετε κι εσείς μέσω επαναχρησιμοποίησης και ανακύκλωσης των αποβλήτων των ηλεκτρικών στηλών, και του ηλεκτρικού και ηλεκτρονικού εξοπλισμού σας στη μείωση της ζήτησης πρώτων υλών.

Απόβλητα ηλεκτρικών στηλών (προπαντός ηλεκτρικών στηλών ιόντων λιθίου) και ηλεκτρικού και ηλεκτρονικού εξοπλισμού περιέχουν πολύτιμες, επαναχρησιμοποιήσιμες ύλες που μπορεί να βλάπτουν το περιβάλλον και την υγεία σας κατά τη μη περιβαλλοντικώς ορθή διάθεσή τους.

Πριν την απόρριψη να διαγράφετε δεδομένα προσωπικού χαρακτήρα που πιθανόν να υπάρχουν στα απόβλητα του εξοπλισμού σας.



Ευρωπαϊκό σήμα πιστότητας



Βρετανικό σήμα πιστότητας



Ουκρανικό σήμα πιστότητας



Ευρασιατικό σήμα πιστότητας

ΤΕΧΝΙΚΑ ΣΤΟΙΧΕΙΑ

Κατηγορία αντοχής για σκόνη και νερό	IP54
Φακός	14 mm
Εστιακό σημείο	35 mm
Μέγιστη απόσταση μέτρησης	50 μέτρα (ανοχή: 55 m)
Ελάχιστη απόσταση μέτρησης	0,05 μέτρα
Απόλυτη ακρίβεια @ < 10m	± 1,5 mm (Max)
Ακρίβεια επανάληψης @ < 10	± 1,5 mm (τιμή αναφοράς max. 2σ)
Ακρίβεια επανάληψης @ > 10	αύξηση κατά ± 0,25 mm / μέτρο (τιμή αναφοράς max. 2σ)
Χρόνος μέτρησης	0,5 s
Τύπος οθόνης	LCD (22,7mm x 31 mm)
Ηλεκτρική τροφοδοσία	AAA 2x (αλκαλική μπαταρία)
Χρόνος ζωής μπαταρίας	10000 (μεμονωμένες μετρήσεις)
Ισχύς εξόδου laser	0,6 mW ~ 0,95 mW (κλάση 2, 650nm)
Μέγεθος στίγματος laser	25 x 30 mm @ 16 m (Max)
Κατηγορία λέιζερ	2
Τύπος λέιζερ	650 nm, < 1 mW
Κατακόρυφη γωνία ακτίνας laser	+1 μοίρα
Οριζόντια γωνία ακτίνας laser	±1 μοίρα
Αυτόματη απενεργοποίηση συσκευής	180 δευτερόλεπτα
Αυτόματη απενεργοποίηση laser	30 δευτερόλεπτα
Περιοχή θερμοκρασίας λειτουργίας	-10°C μέχρι +50°C
Περιοχή θερμοκρασίας αποθήκευσης	-25°C μέχρι +70°C
Βάρος χωρίς μπαταρία	80 g

ΧΡΗΣΗ ΣΥΜΦΩΝΑ ΜΕ ΤΟ ΣΚΟΠΟ ΠΡΟΟΡΙΣΜΟΥ

Η συσκευή μέτρησης αποστάσεως με ακτίνα laser είναι κατάλληλη για μετρήσεις απόστασης και κλίσης.

Αυτή η συσκευή επιτρέπεται να χρησιμοποιηθεί μόνο σύμφωνα με τον αναφερόμενο σκοπό προορισμού.

ΠΙΝΑΚΑΣ ΚΩΔΙΚΩΝ ΣΦΑΛΜΑΤΩΝ

Κωδικός	Περιγραφή	Λύση
Err01	Εκτός περιοχής μέτρησης	Διεξάγετε την μέτρηση μέσα στην προβλεπόμενη περιοχή μέτρησης.
Err02	Το ανακλώμενο σήμα είναι πολύ αδύναμο	Διαλέξτε μια καλύτερη επιφάνεια.
Err03	Εκτός περιοχής ένδειξης (μεγ. τιμή: 99.999) π.χ. το αποτέλεσμα της επιφάνειας ή του όγκου ξεπερνά τη μέγιστη τιμή ένδειξης	Ελέγξτε αν οι τιμές και τα βήματα της διαδικασίας είναι σωστά.
Err04	Σφάλμα στον πυθαγόρειο υπολογισμό	Ελέγξτε αν οι τιμές και τα βήματα της διαδικασίας είναι σωστά.
Err05	Αδύναμη μπαταρία	Βάλτε καινούριες μπαταρίες
Err06	Εκτός περιοχής θερμοκρασίας λειτουργίας	Διεξάγετε την μέτρηση μέσα στην προβλεπόμενη περιοχή θερμοκρασίας.
Err07	Περιβάλλον πολύ φωτεινό	Φροντίστε ώστε η περιοχή μέτρησης να μην είναι πολύ φωτεινή.

Πυθαγόρας
Διαφορά ύψους

Επίπεδο μέτρησης

Μέτρηση μήκους

Ελάχιστο / μέγιστο για συνεχή μέτρηση

Πρόσθεση / αφαίρεση

ON / ΜΕΤΡΗΣΗ

- ▶ On
- ▶ Μέτρηση
- ▶ Συνεχής μέτρηση (πιέστε για 2 δευτερόλεπτα)
Μέγιστο / ελάχιστο Λειτουργία

ΠΡΟΣΘΕΣΗ / ΑΦΑΙΡΕΣΗ

- ▶ Πρόσθεση τιμής
- ▶ Πλοήγηση στη μνήμη

ΕΠΙΦΑΝΕΙΑ / ΟΓΚΟΣ

- ▶ Επιφάνεια (πιέστε 1x)
- ▶ Όγκος (πιέστε 2x)
- ▶ Έμμεση μέτρηση επιφάνειας (πιέστε 3x / 4x)

ΕΝΕΡΓΟΠΟΙΗΣΗ

- ▶ On
- ▶ Off (πιέστε για 2 δευτερόλεπτα)
- ▶ Διαγραφή

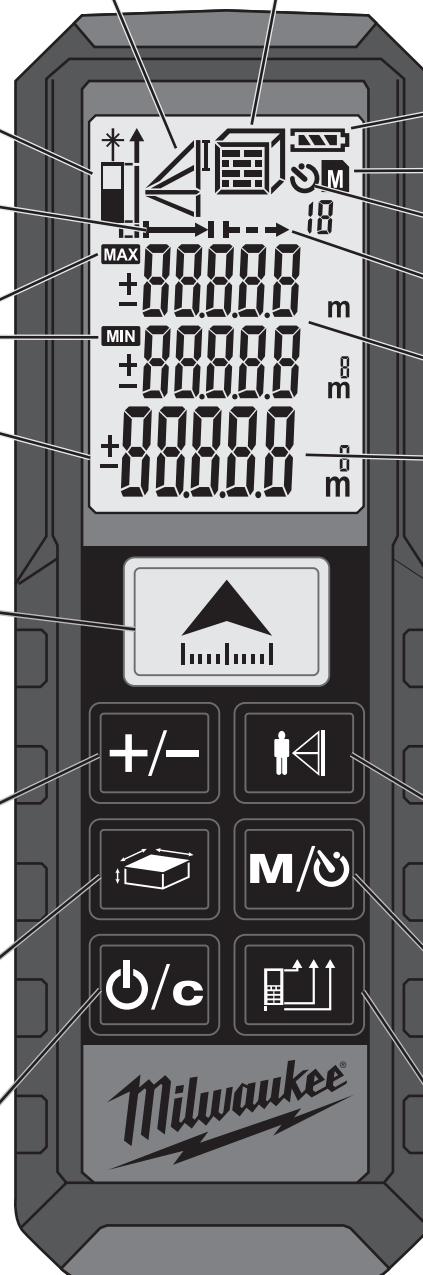

Επιφάνεια / όγκος
Έμμεση μέτρηση επιφάνειας

Κατάσταση μπαταρίας

Μνήμη

Χρονοδιακόπτης

Συνεχής μέτρηση

Ενδιάμεσες τιμές

Συνολική τιμή

ΠΥΘΑΓΟΡΑΣ

- ▶ Πυθαγόρας 1 (πιέστε 1x)
- ▶ Πυθαγόρας 2 (πιέστε 2x)
- ▶ Πυθαγόρας 3 (πιέστε 3x)

ΜΝΗΜΗ

- ▶ Χρονοδιακόπτης 3-15 δευτερόλεπτα (πιέστε 1x)
- ▶ Μνήμη 1-20 (πιέστε 1x για 2 δευτερόλεπτα)
- ▶ Ανάκληση των τιμών μνήμης (πιέστε επανειλημμένα)

ΑΛΛΑΓΗ ΕΠΙΠΕΔΟΥ ΜΕΤΡΗΣΗΣ

- ▶ Μπροστά
- ▶ Πίσω
- ▶ Ακίδα γωνίας

ΑΛΛΑΓΗ ΜΠΑΤΑΡΙΑΣ

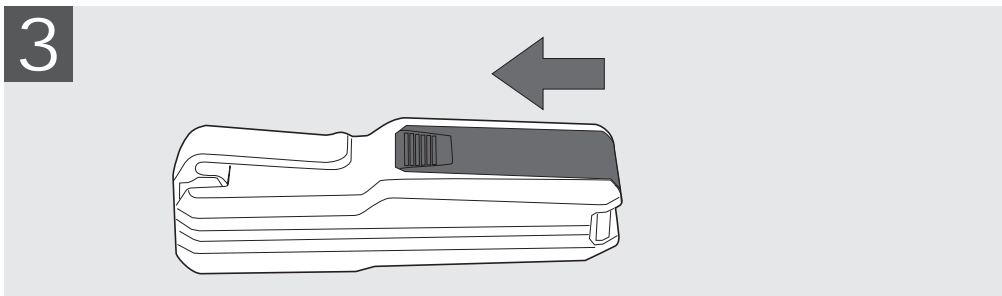
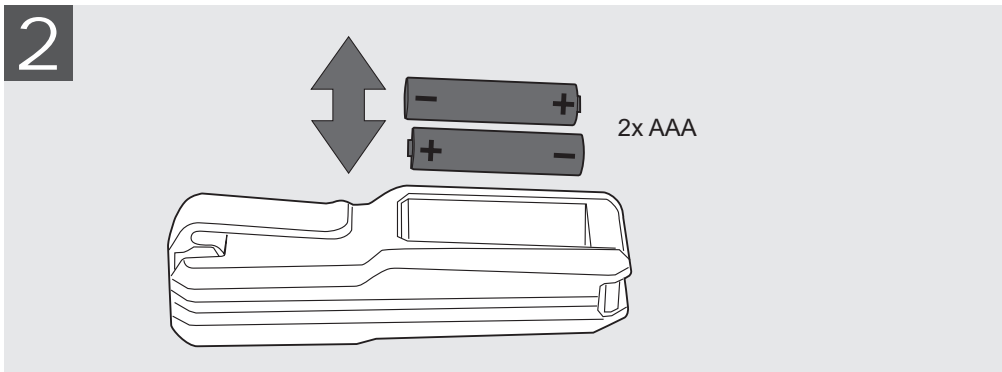
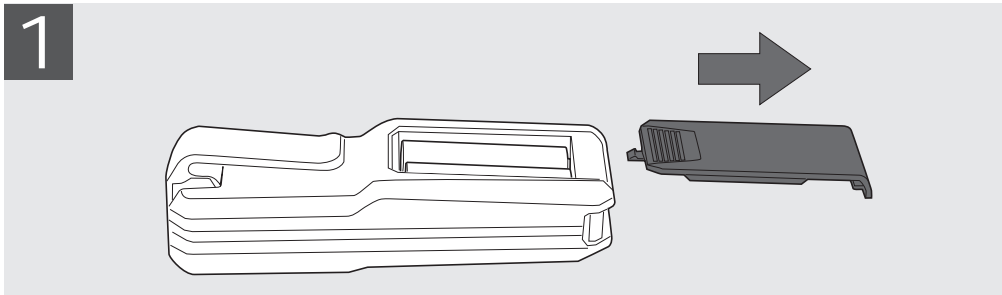
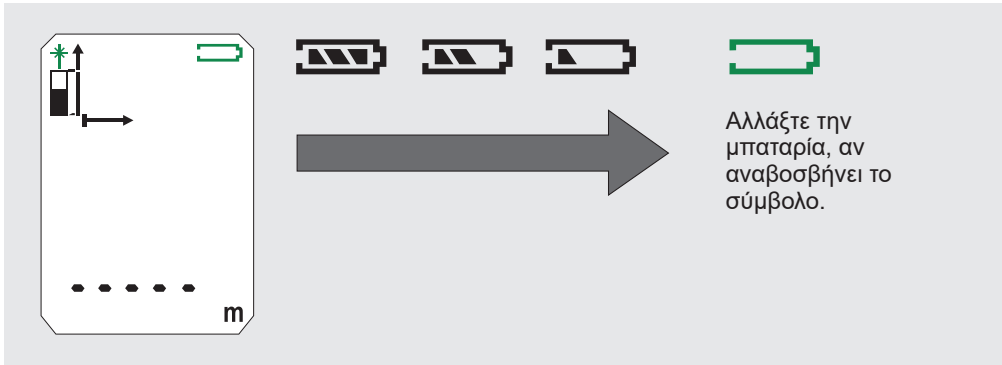

ΑΚΙΔΑ ΓΩΝΙΑΣ

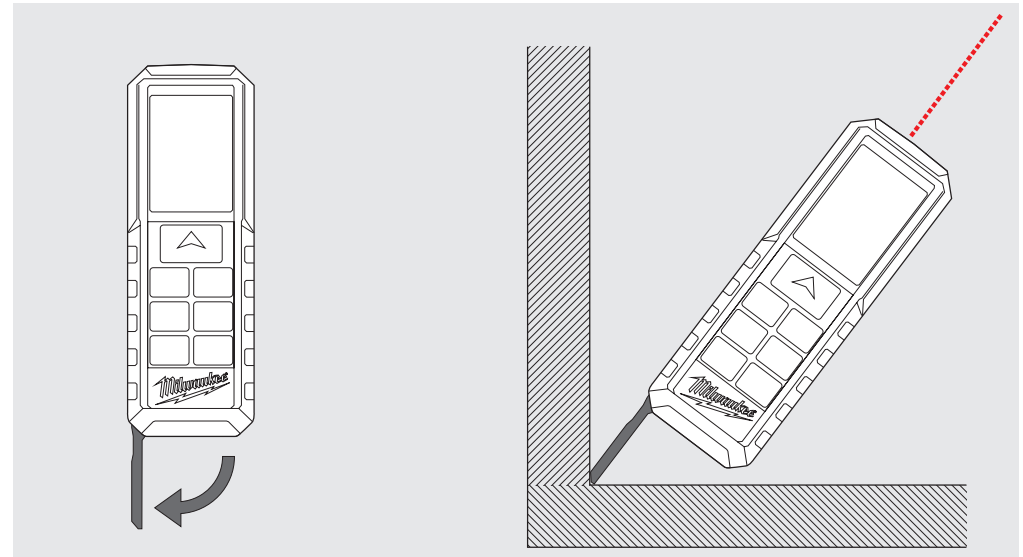

ΚΛΙΠ ΖΩΝΗΣ

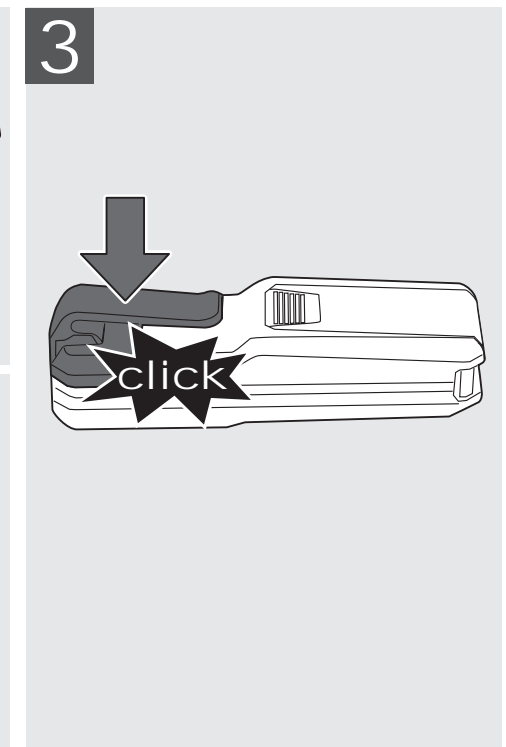
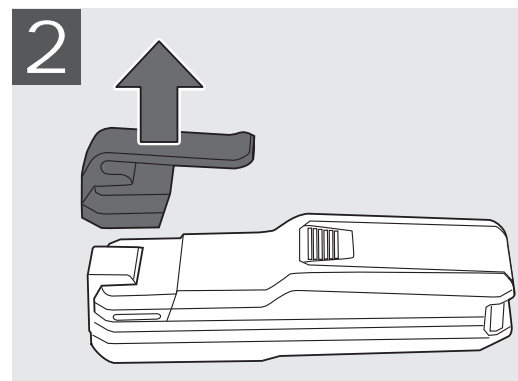
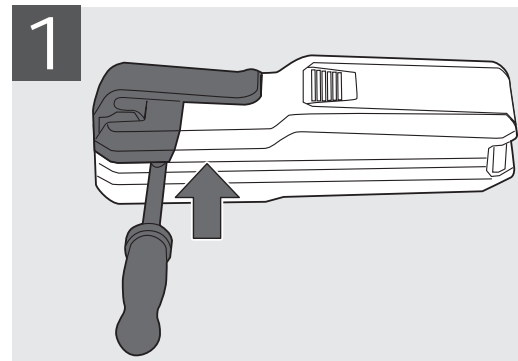

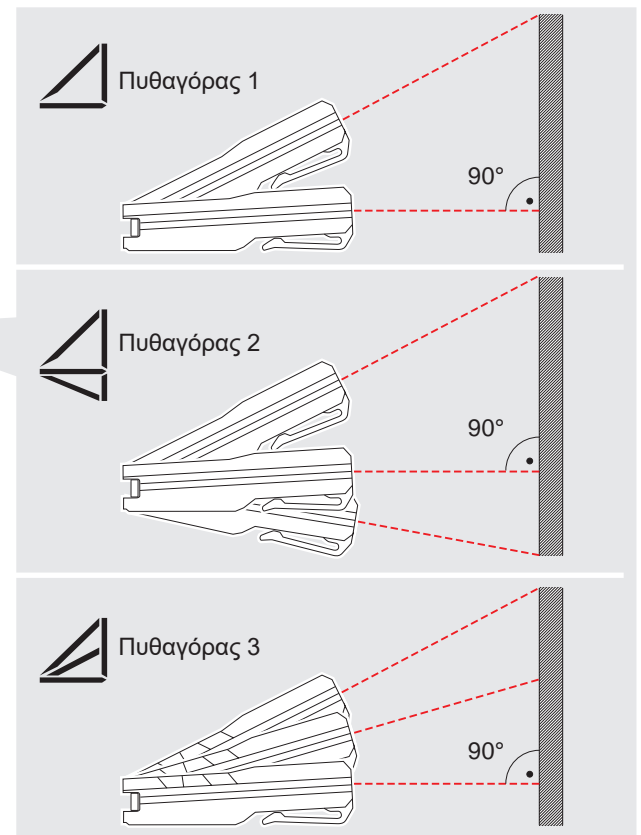
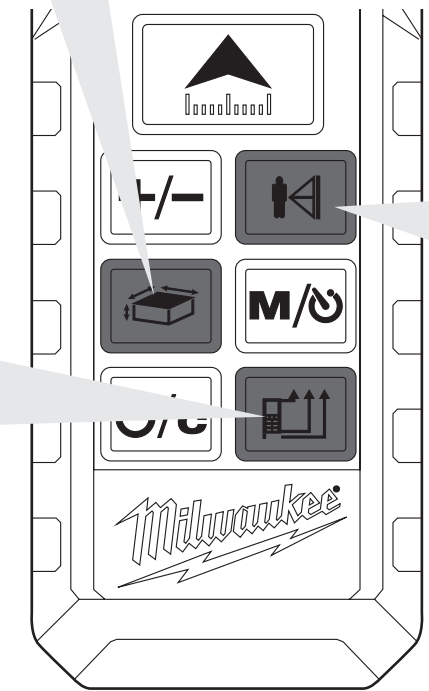
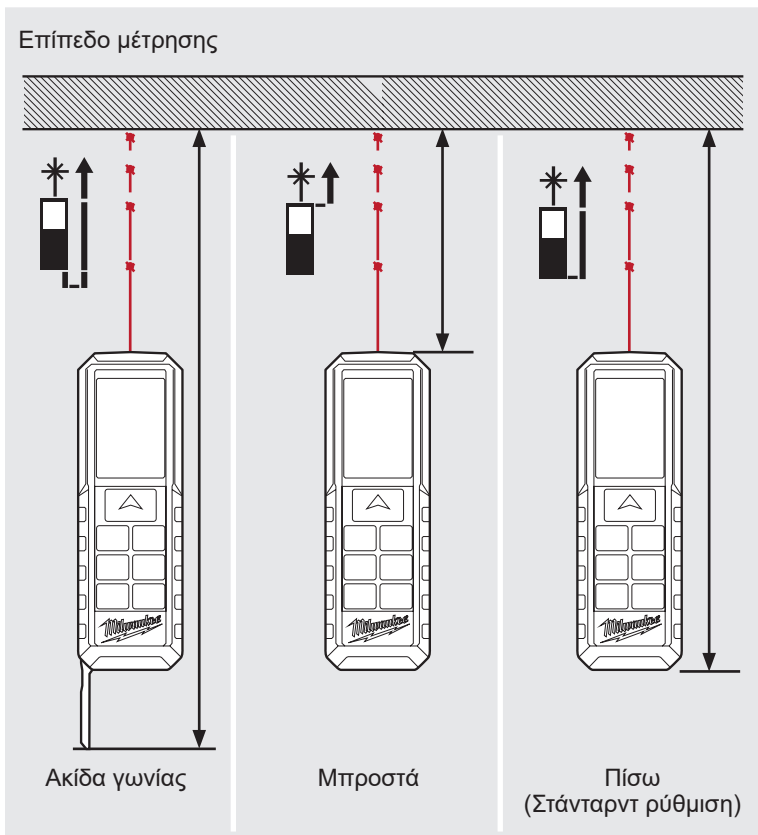
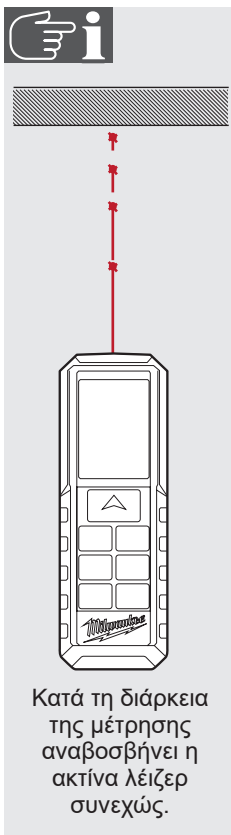
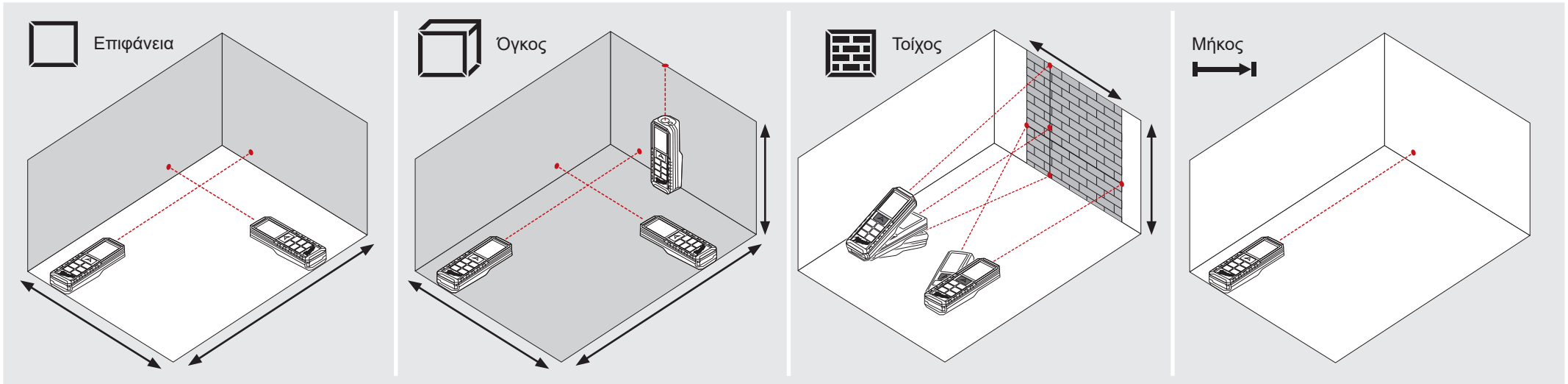

0

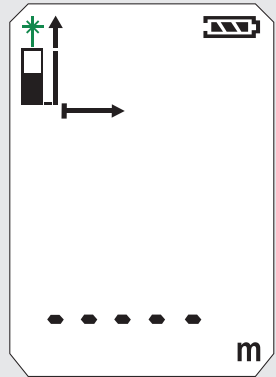

1

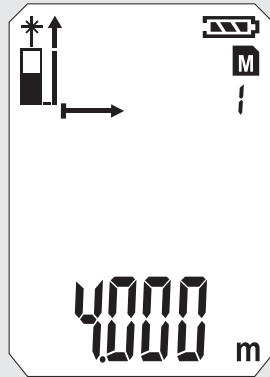

2

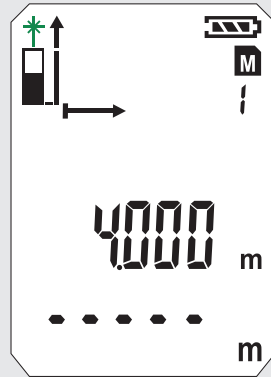

3

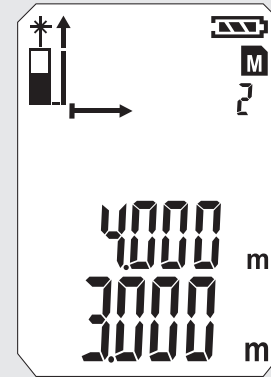

4

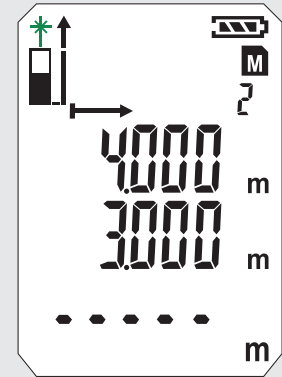

5

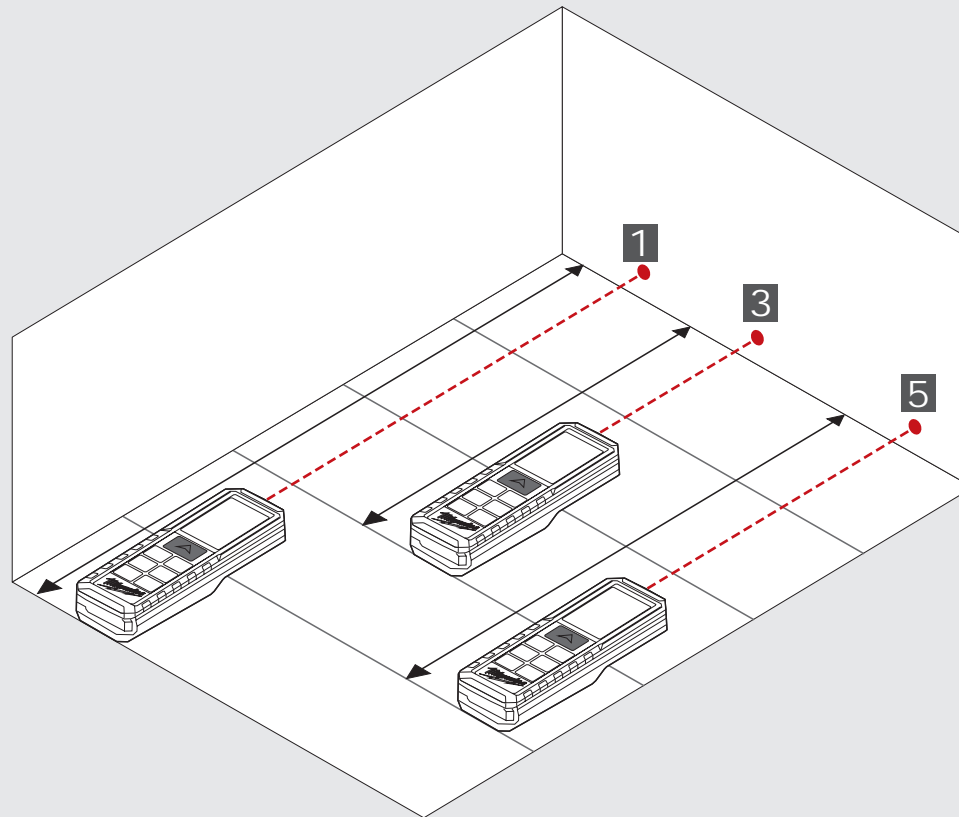
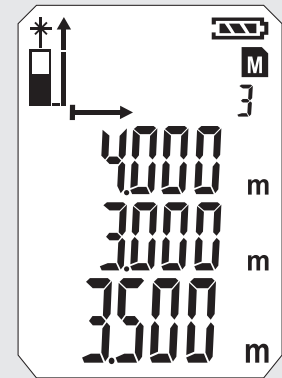

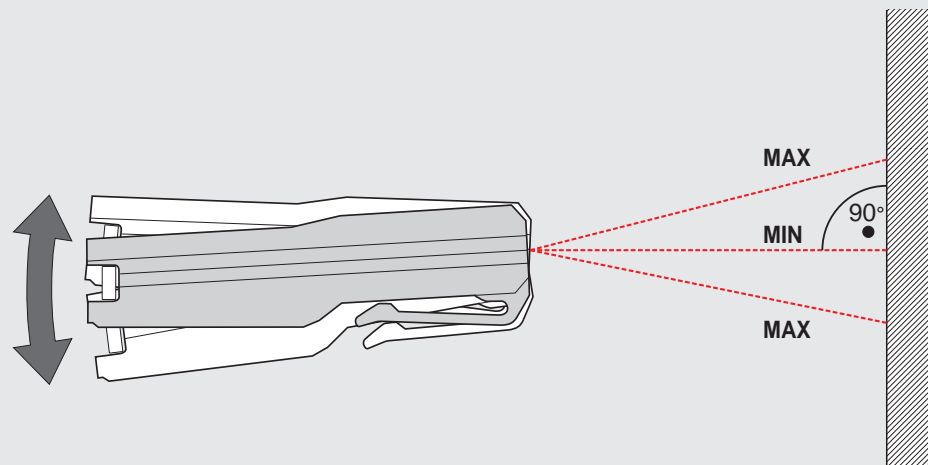
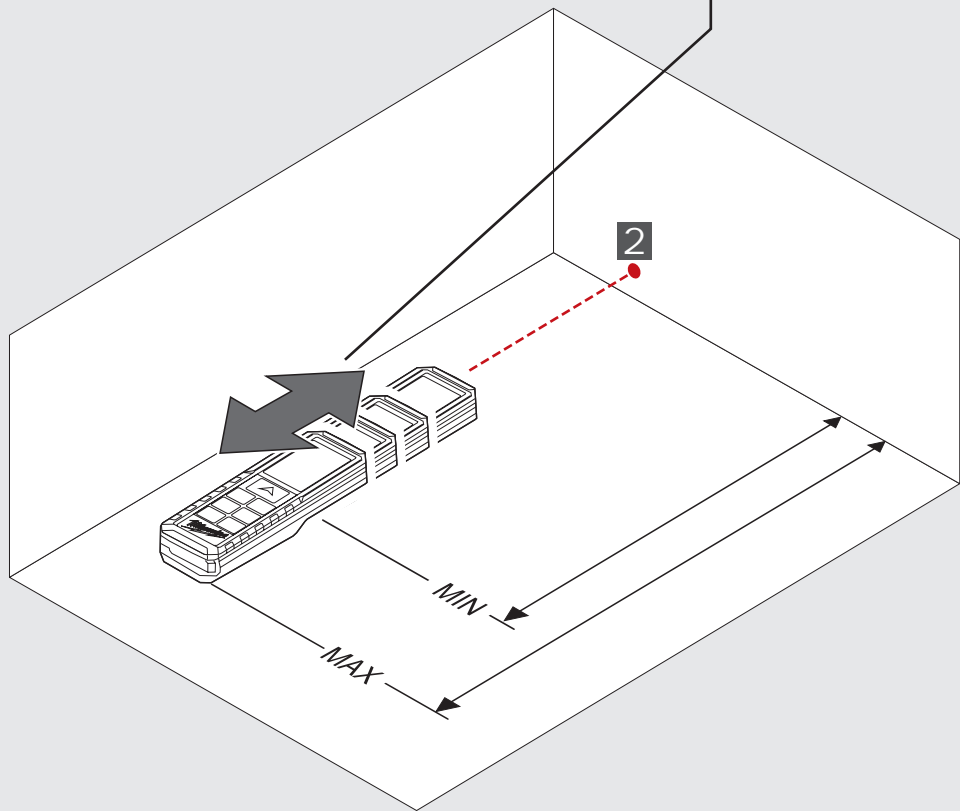
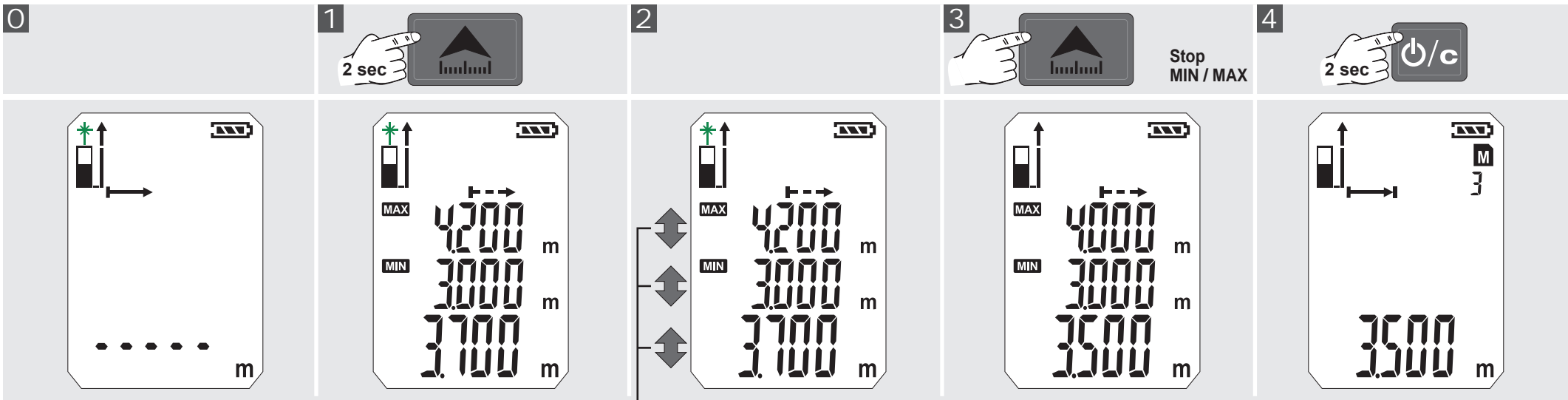

0

1

2

3

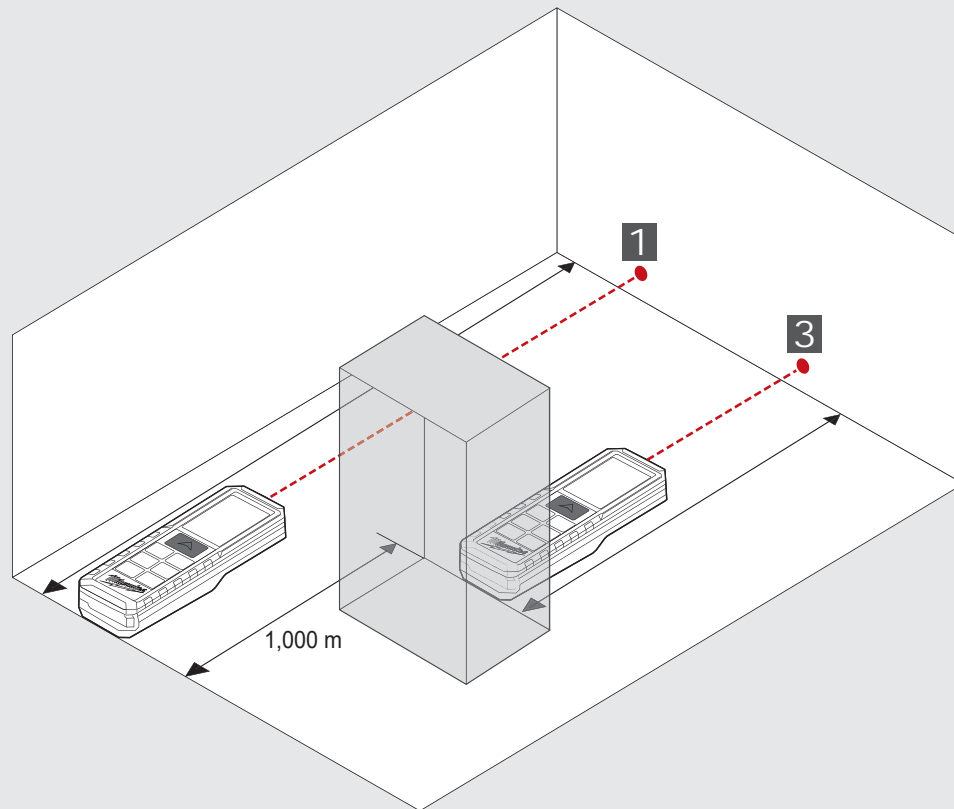
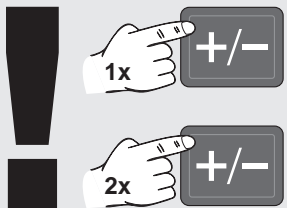
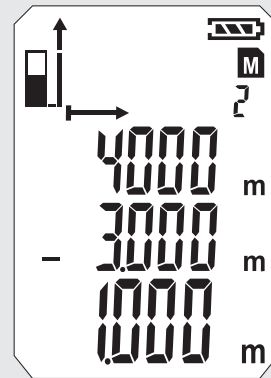
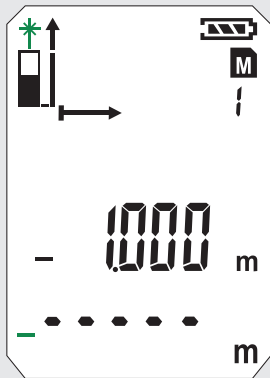
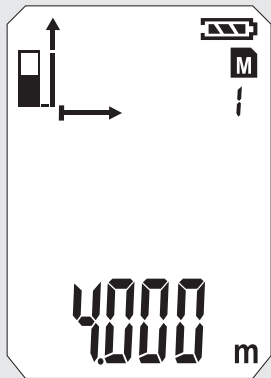
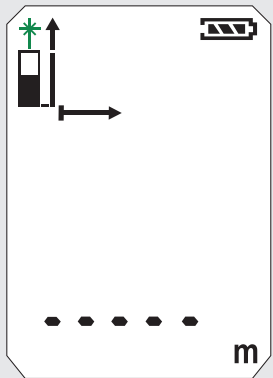

0



1



2

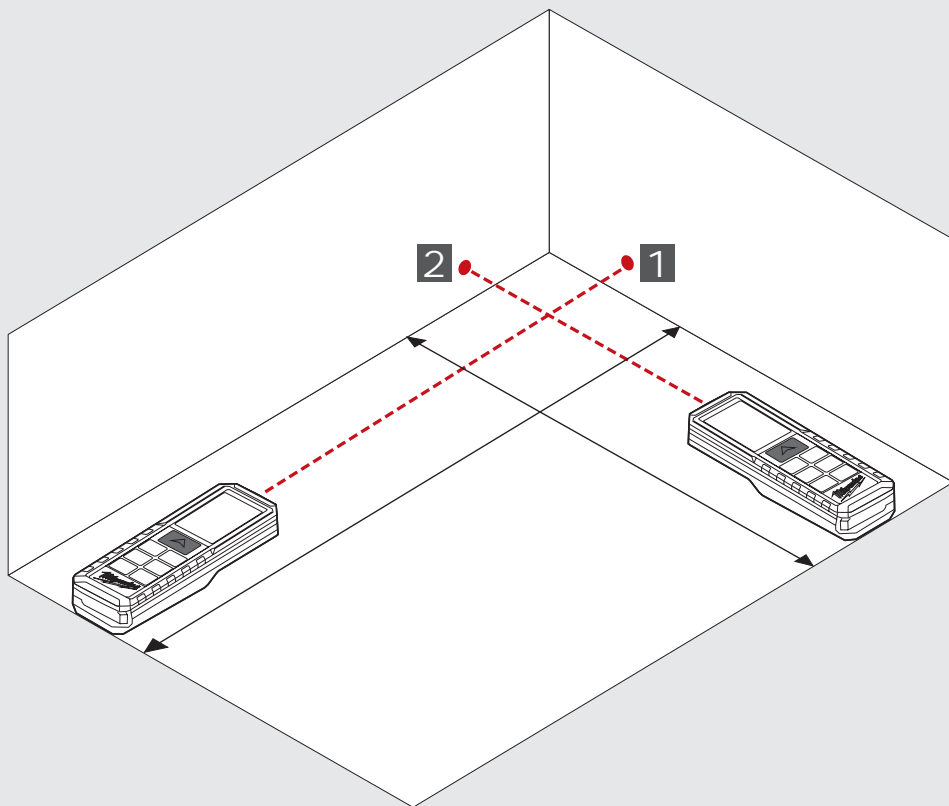
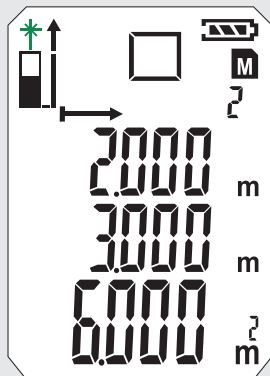
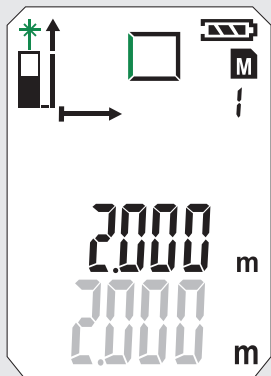
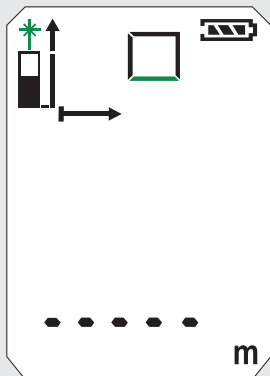

0



1



2



3

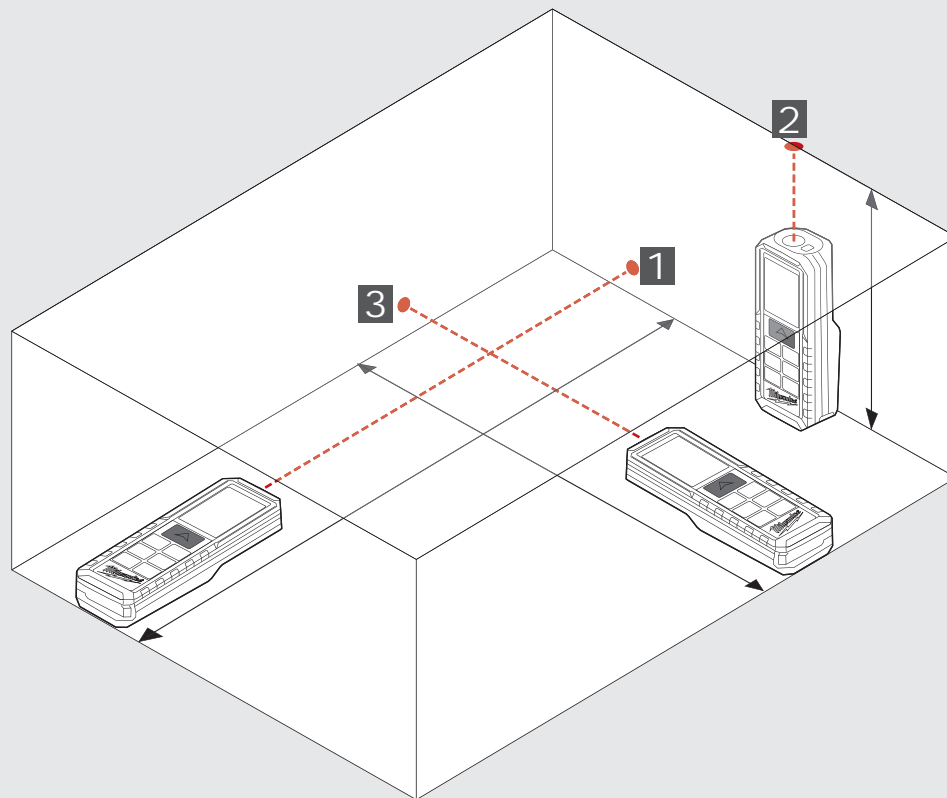
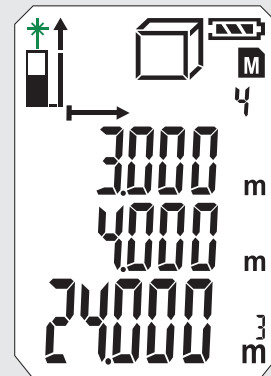
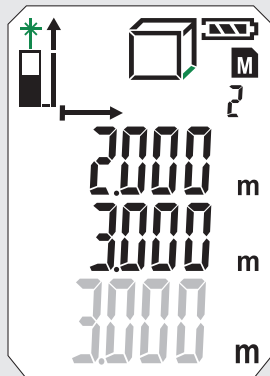
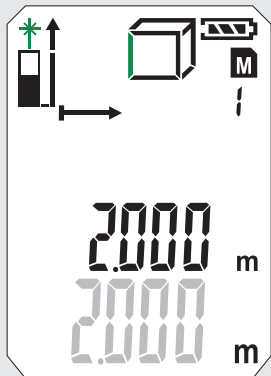
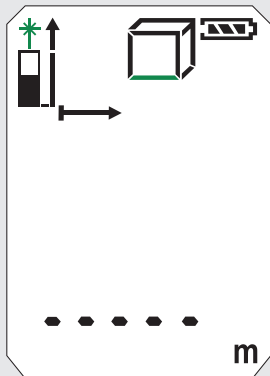

ΕΜΜΕΣΗ ΜΕΤΡΗΣΗ (ΠΥΘΑΓΟΡΑΣ 1)

0



1 x





1

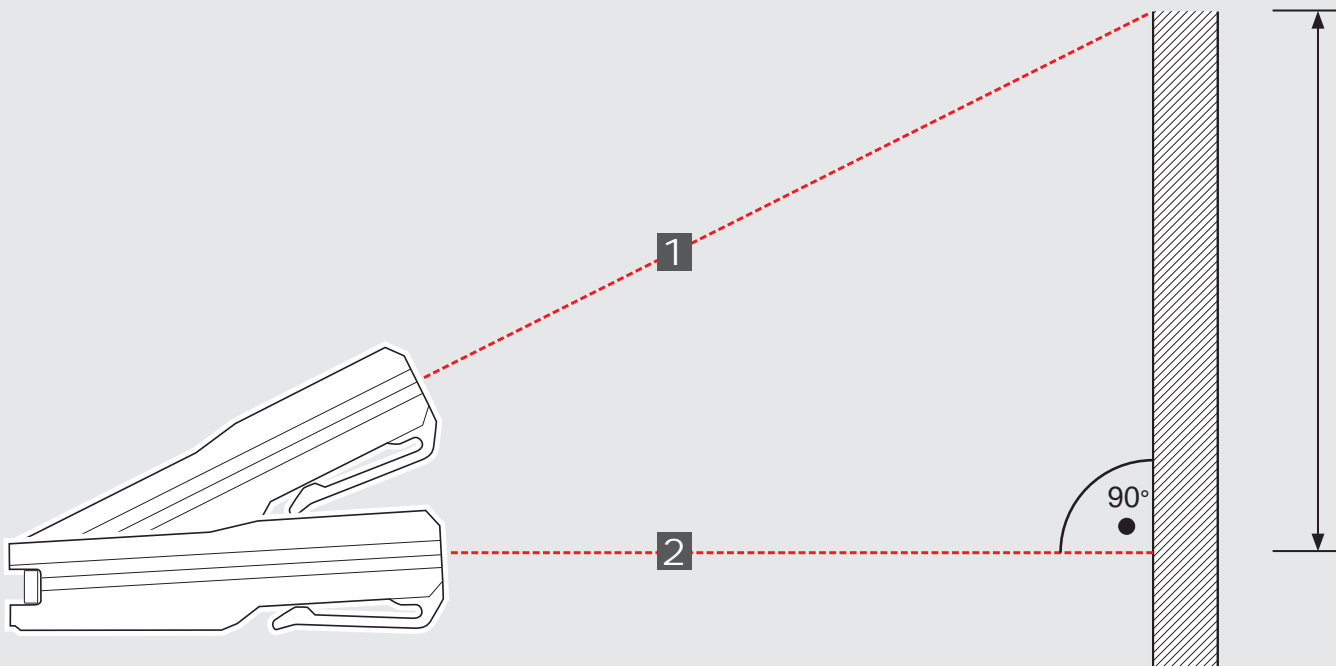
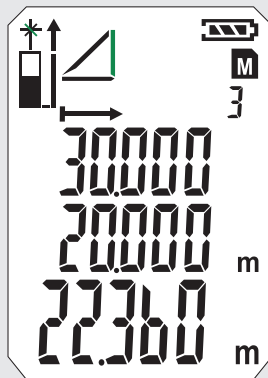
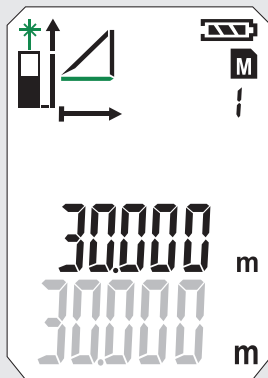
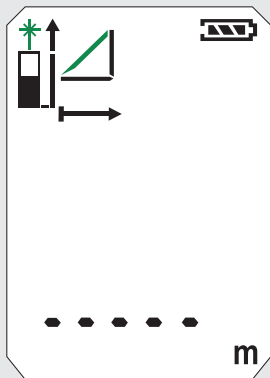

2

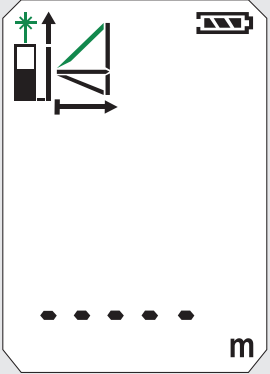
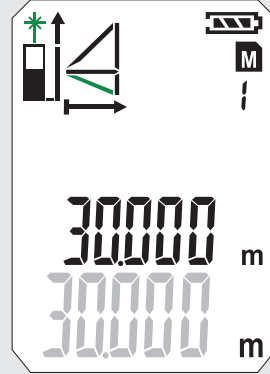
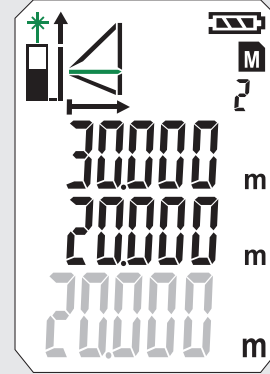
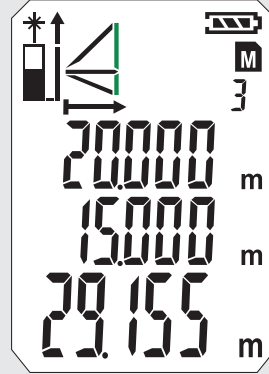

ΕΜΜΕΣΗ ΜΕΤΡΗΣΗ (ΠΥΘΑΓΟΡΑΣ 2)

<p>0</p>  <p>2 x</p>	<p>1</p> 	<p>2</p> 	<p>3</p> 
			

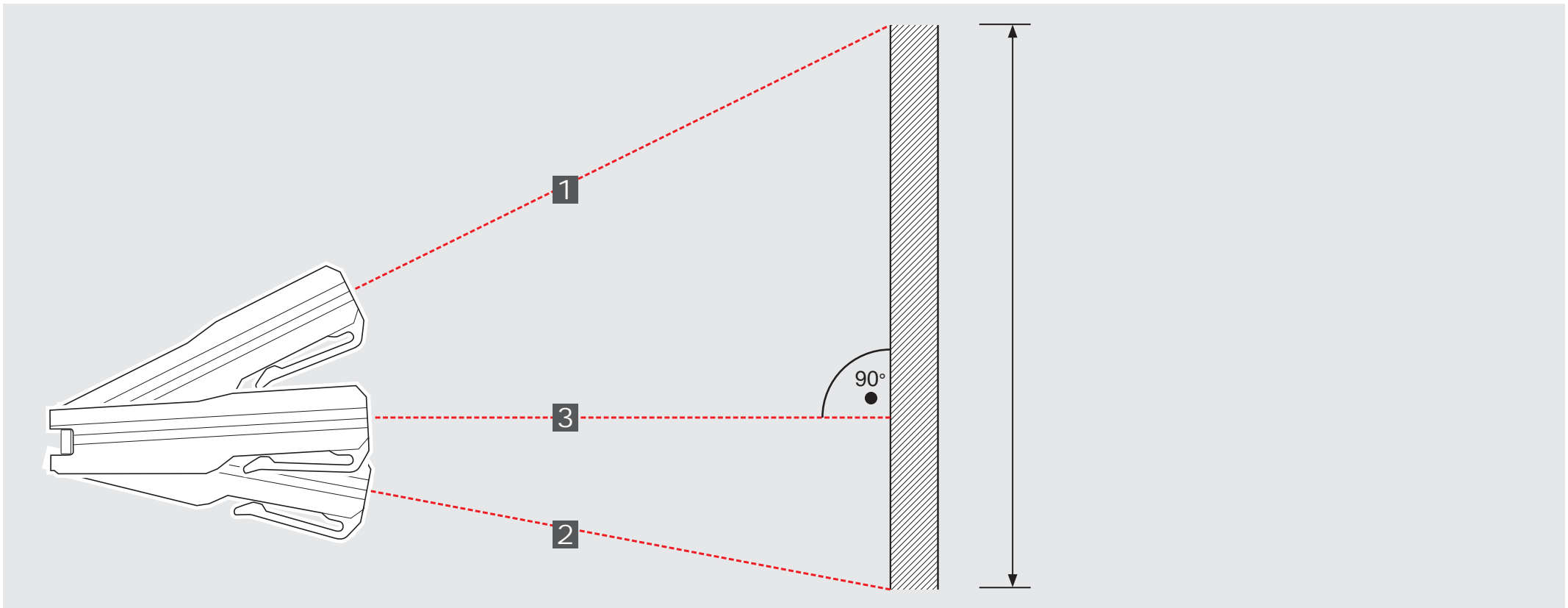

ΕΜΜΕΣΗ ΜΕΤΡΗΣΗ (ΠΥΘΑΓΟΡΑΣ 3)

1



2







3

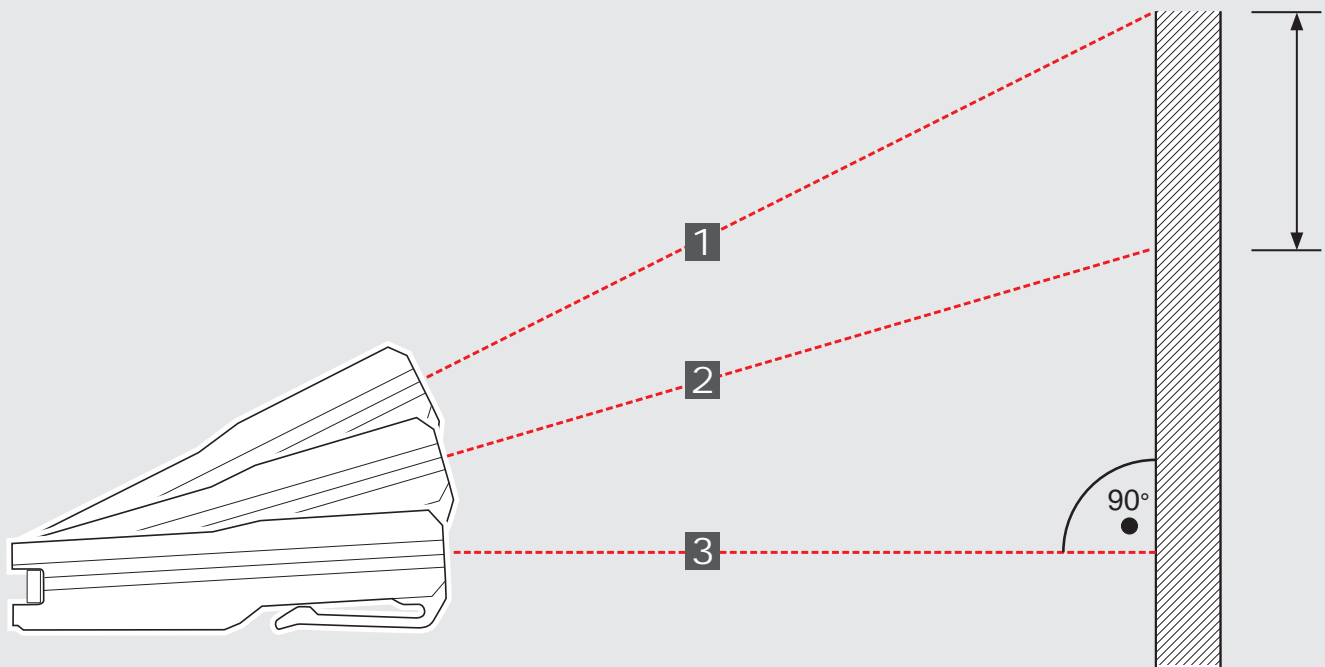
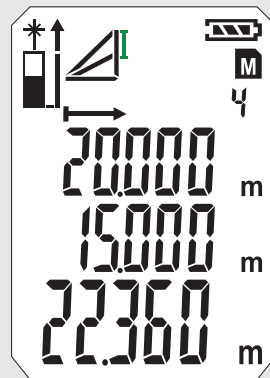
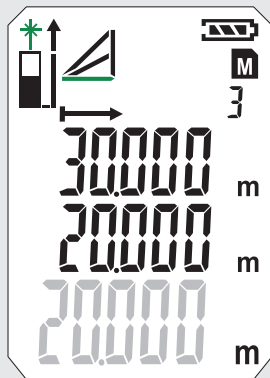
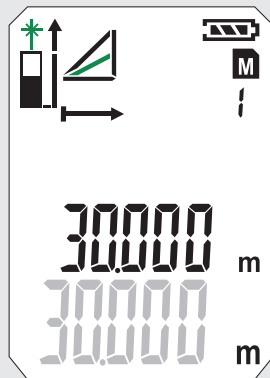
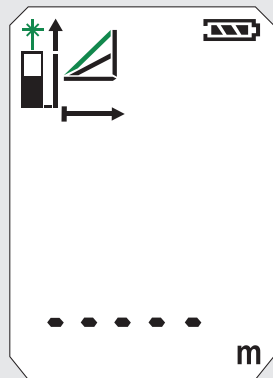

4

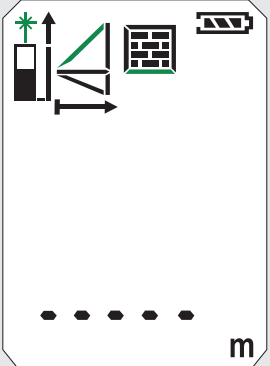
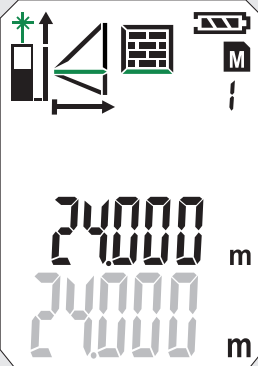
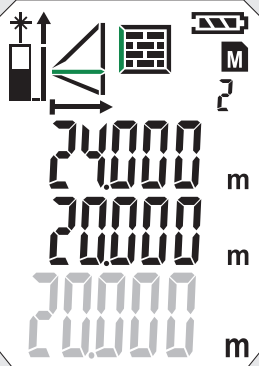
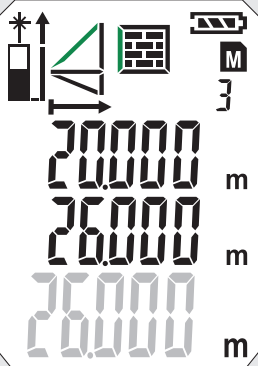
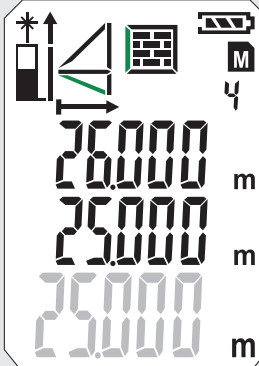

ΜΕΤΡΗΣΗ ΕΠΙΦΑΝΕΙΑΣ ΤΟΙΧΟΥ (ΔΙΑΔΙΚΑΣΙΑ 1)

<p>0</p> 	<p>1</p> 	<p>2</p> 	<p>3</p> 	<p>4</p> 
				

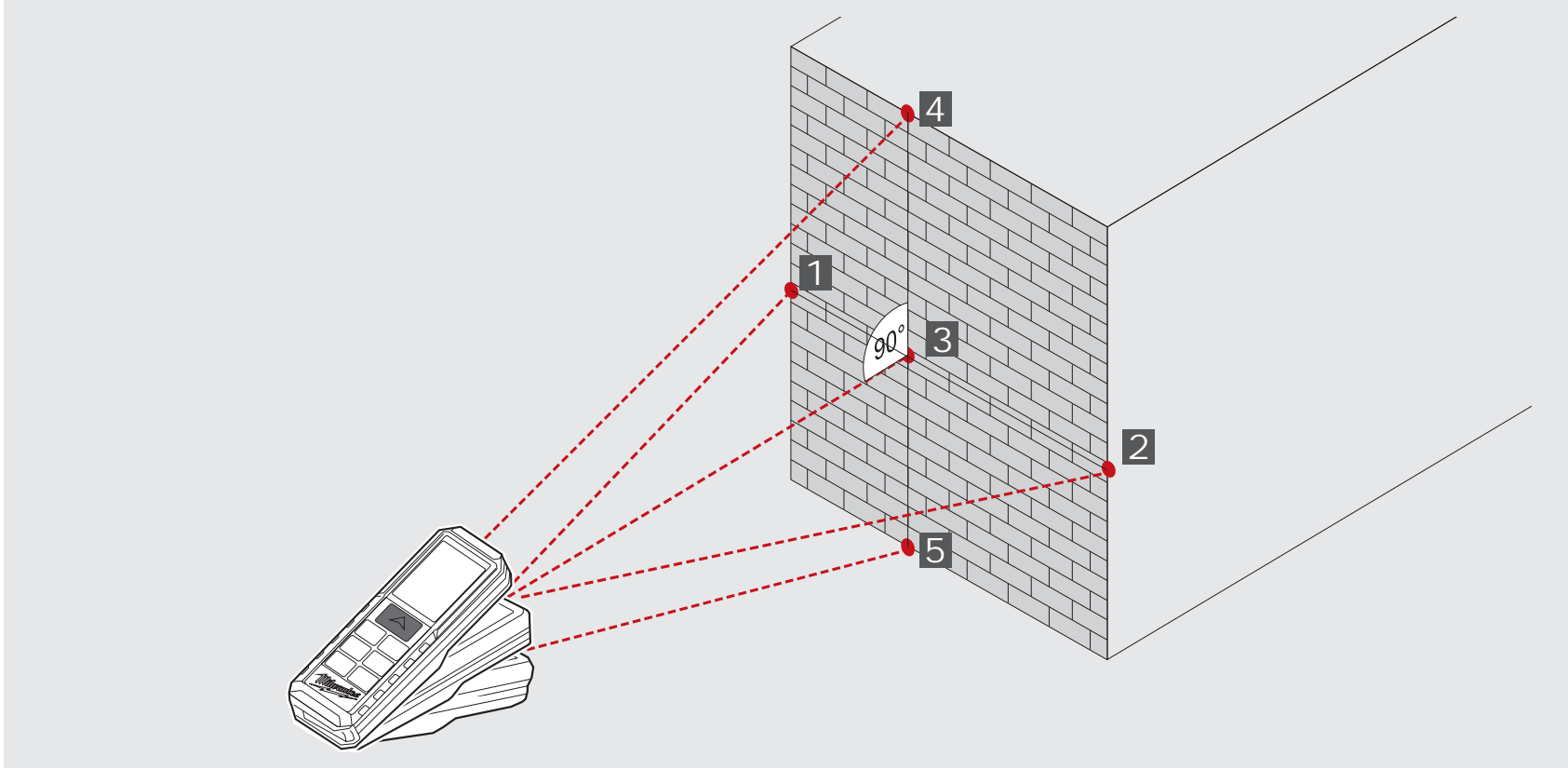



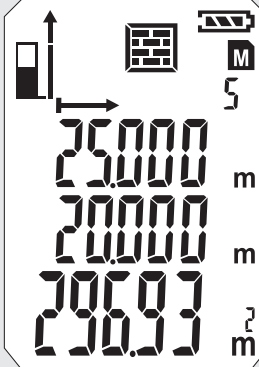

5



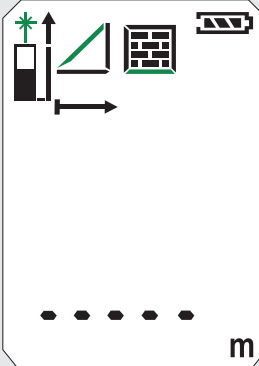
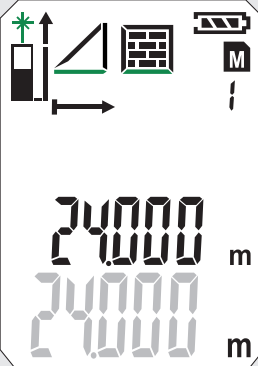
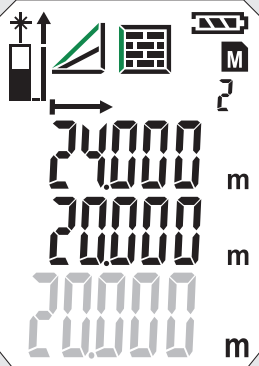
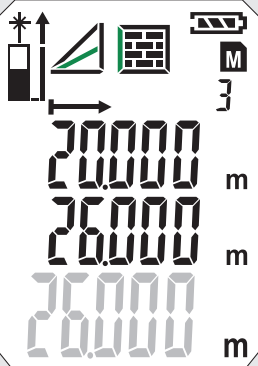
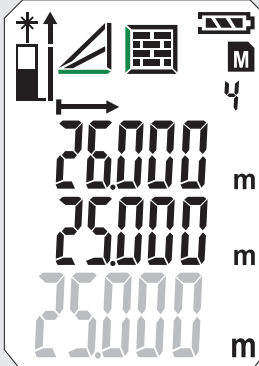

ΜΕΤΡΗΣΗ ΕΠΙΦΑΝΕΙΑΣ ΤΟΙΧΟΥ (ΔΙΑΔΙΚΑΣΙΑ 2)

<p>0</p> 	<p>1</p> 	<p>2</p> 	<p>3</p> 	<p>4</p> 
				

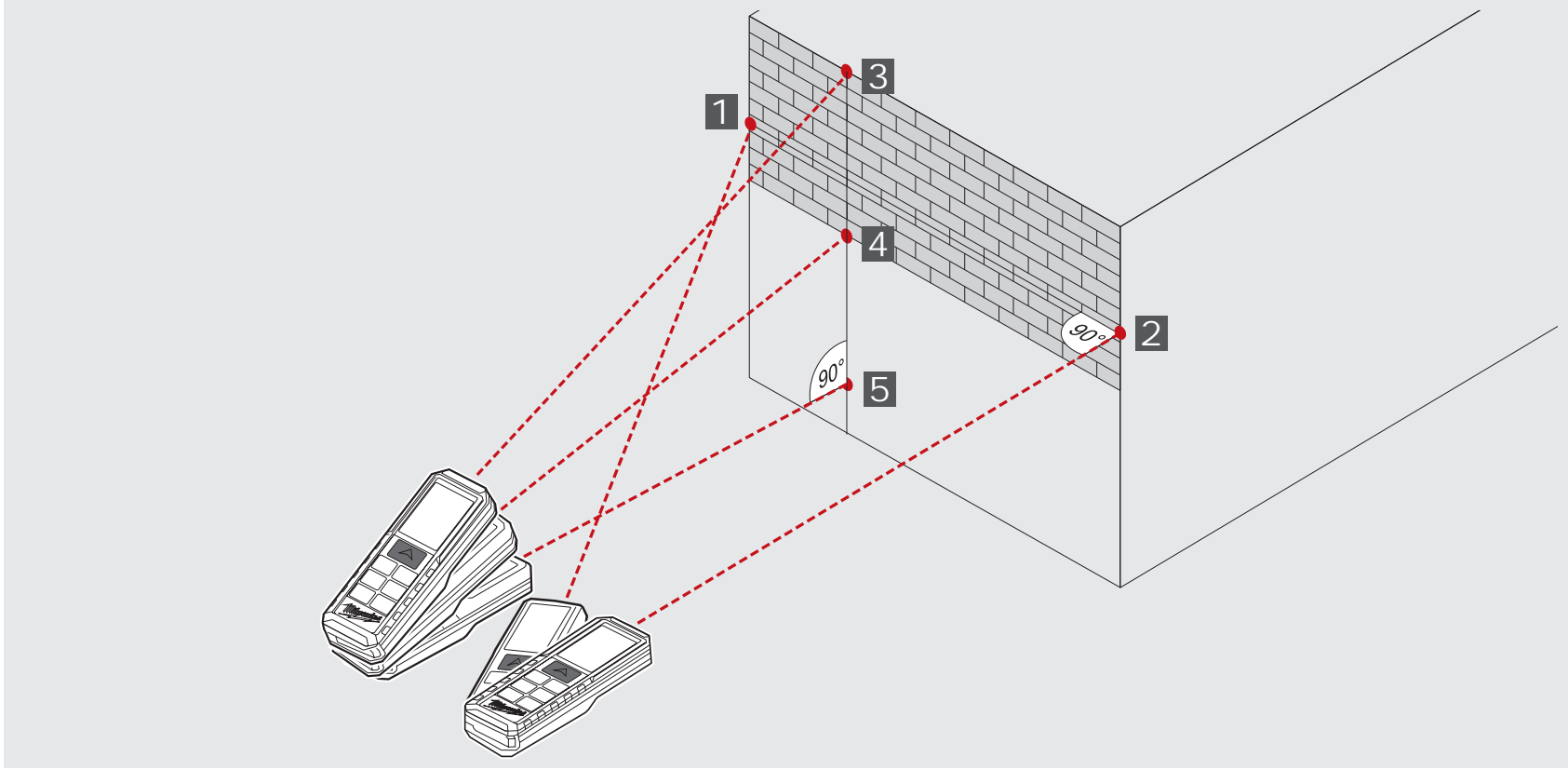

5

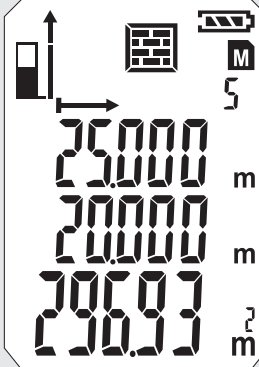



ΧΡΟΝΟΔΙΑΚΟΠΤΗΣ

Χρησιμοποιώντας τον χρονοδιακόπτη μπορείτε να διενεργήσετε την μέτρηση με καθυστέρηση, ούτως ώστε να τοποθετήσετε π.χ. ένα εξάρτημα στην ακτίνα μέτρησης

Πιέστε το πλήκτρο 

- Το σύμβολο εμφανίζεται
Πιέζοντας το πλήκτρο  μπορείτε να ρυθμίσετε τον χρονοδιακόπτη ανάμεσα σε 3 και 15 δευτερόλεπτα.

Πιέστε το πλήκτρο 

- Αντίστροφη μέτρηση των δευτερολέπτων μέχρι την μέτρηση.

- Στο 0 λαμβάνει χώρα η μέτρηση.

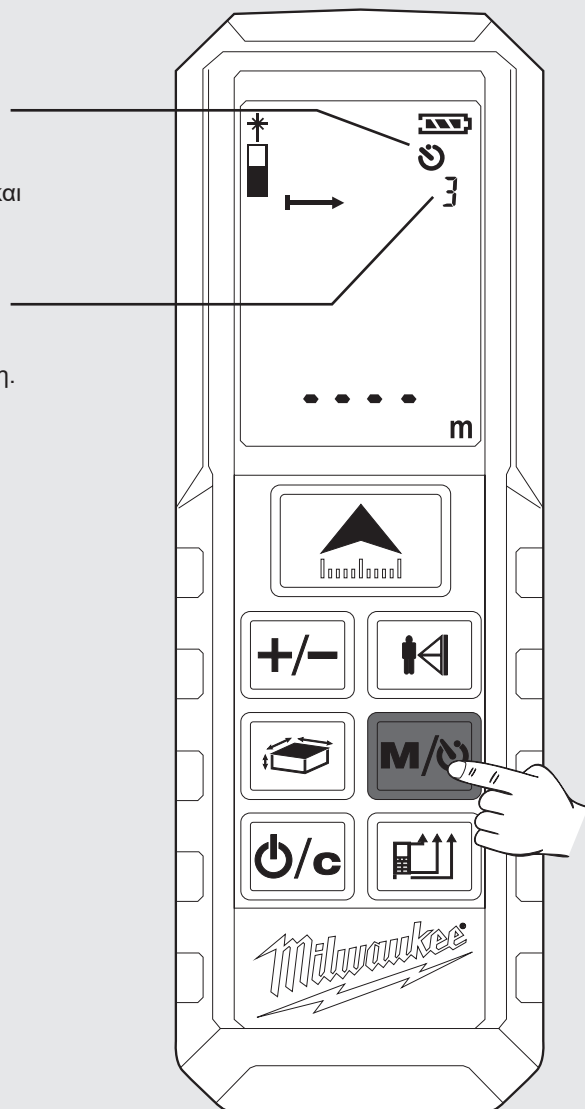

ΜΝΗΜΗ

Οι τιμές μέτρησης αποθηκεύονται διαδοχικά και αυτόματα στην μνήμη.

Οι αποθηκευμένες τιμές μπορούν να ανακληθούν πιέζοντας το πλήκτρο .

Πιέστε το πλήκτρο  για 2 δευτερόλεπτα.

- Εμφανίζεται το σύμβολο και ο αριθμός θέσης μνήμης.

- Εμφανίζεται το αντίστοιχο μέγεθος μέτρησης.

- Εμφανίζεται η αποθηκευμένη τιμή στην κύρια γραμμή.

- Ανακαλέστε τις τιμές μνήμης πιέζοντας επανειλημμένα το πλήκτρο .

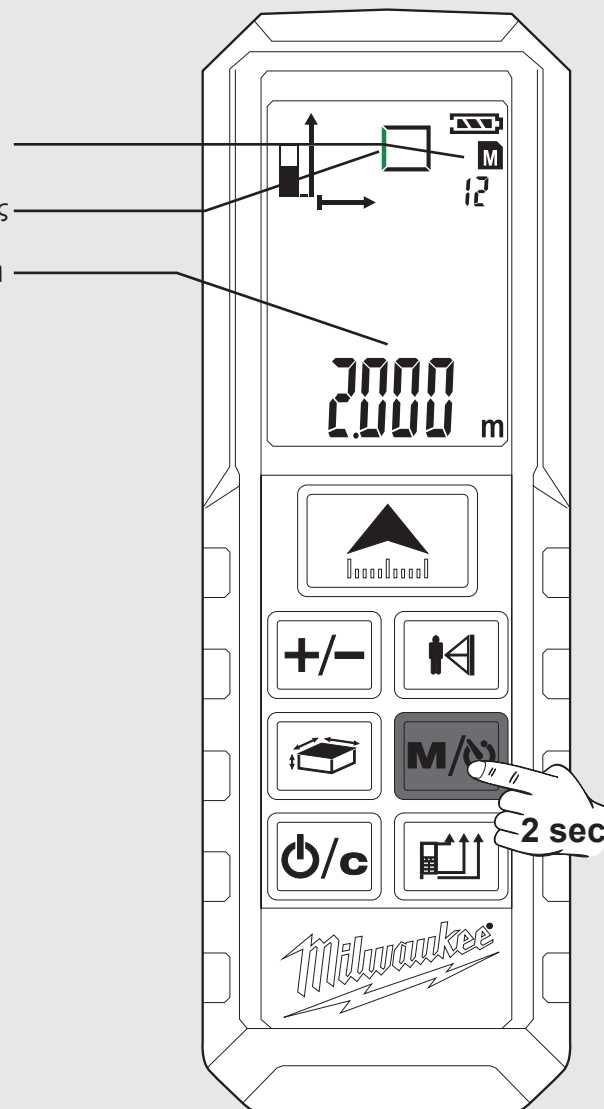

ΠΕΡΙΓΡΑΦΗ ΤΗΣ ΒΑΣΙΚΗΣ ΔΙΑΔΙΚΑΣΙΑΣ ΜΕΤΡΗΣΗΣ ΧΡΗΣΙΜΟΠΟΙΩΝΤΑΣ ΤΟ ΠΑΡΑΔΕΙΓΜΑ ΜΙΑΣ ΜΕΤΡΗΣΗΣ ΕΠΙΦΑΝΕΙΑΣ (1)

1 Ενεργοποιήστε

Πιέστε το πλήκτρο .
⚠ Προσοχή! Το laser είναι ενεργό!
 Μην το στρέφετε πάνω σε ανθρώπους!

2 Επιλογή επιπέδου μέτρησης

Στάνταρντ ρύθμιση μετά την ενεργοποίηση: Πίσω
 Πιέστε 1x -> Ακίδα γωνίας
 Πιέστε 2x -> Μπροστά
 Πιέστε 3x -> Πίσω

3 Επιλογή λειτουργίας

Μετά την ενεργοποίηση η συσκευή είναι ρυθμισμένη σε μέτρηση απόστασης.
 Πιέστε  1x - Μέτρηση επιφάνειας.

4 Μέτρηση μήκους

Ευθυγραμμίστε την συσκευή και πιέστε 

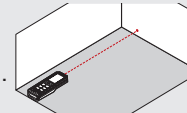

5 Μέτρηση πλάτους

Ευθυγραμμίστε την συσκευή και πιέστε 

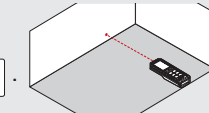

Το σύμβολο laser αναβοσβήνει (Στην εικόνα το πράσινο σύμβολο)

Εμφανίζεται το σύμβολο

- Εμφανίζεται το σύμβολο
 - Το μέγεθος της μέτρησης αναβοσβήνει (Στην εικόνα το πράσινο σύμβολο)

- Η τιμή μέτρησης εμφανίζεται για λίγο στην κύρια γραμμή.
 - Μετά από 1 δευτερόλεπτο η τιμή μέτρησης αλλάζει θέση στην γραμμή από πάνω.
 - Η τιμή μέτρησης αποθηκεύεται στην μνήμη με αύξοντα αριθμό.
 - Αναβοσβήνει το δεύτερο μέγεθος μέτρησης. Η συσκευή είναι έτοιμη για τη μέτρηση της δεύτερης τιμής.

- Η τιμή μέτρησης εμφανίζεται για λίγο στην κύρια γραμμή.
 - Μετά από 1 δευτερόλεπτο η τιμή μέτρησης αλλάζει θέση στην γραμμή από πάνω.
 - Η τιμή μέτρησης αποθηκεύεται στην μνήμη με αύξοντα αριθμό.
 - Το αποτέλεσμα εμφανίζεται στην κύρια γραμμή και αποθηκεύεται στην μνήμη με αύξοντα αριθμό.

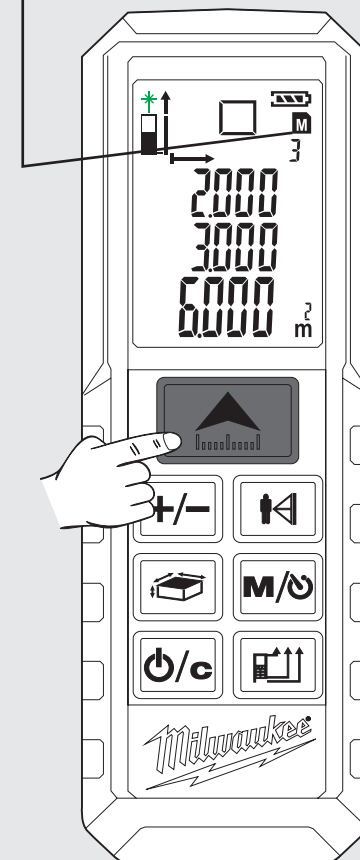
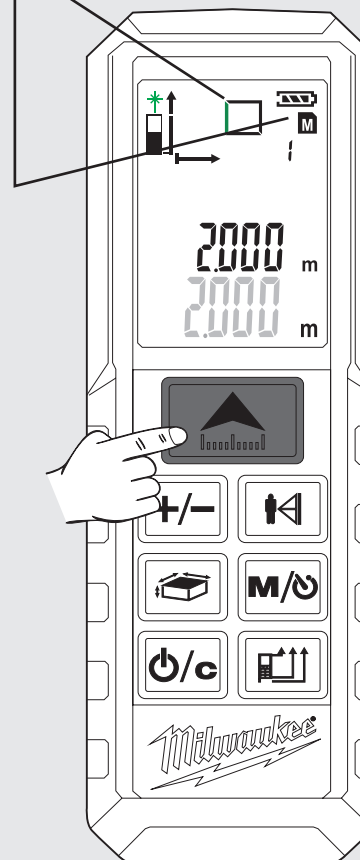
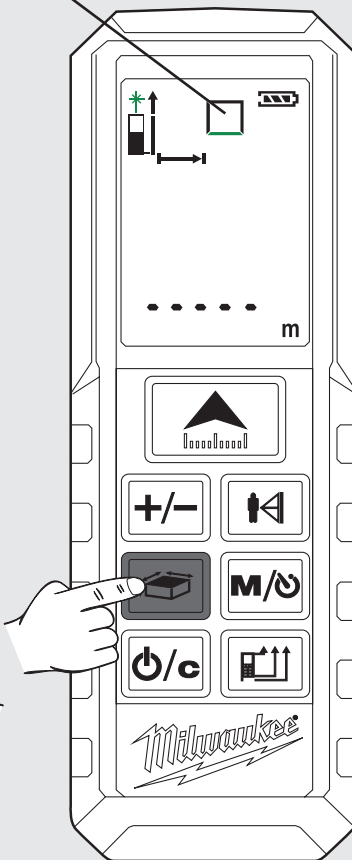
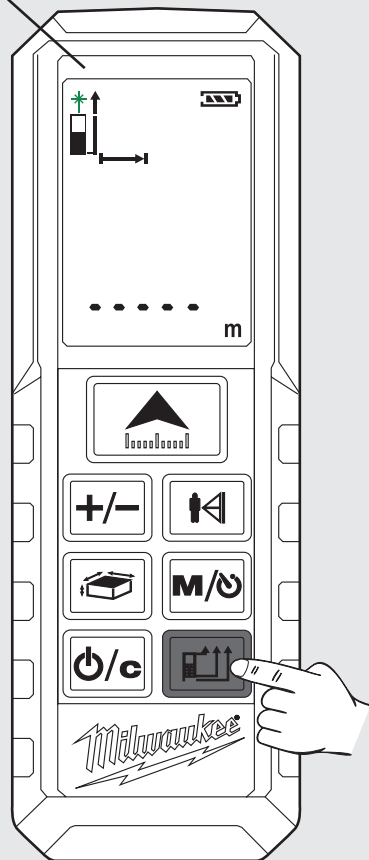
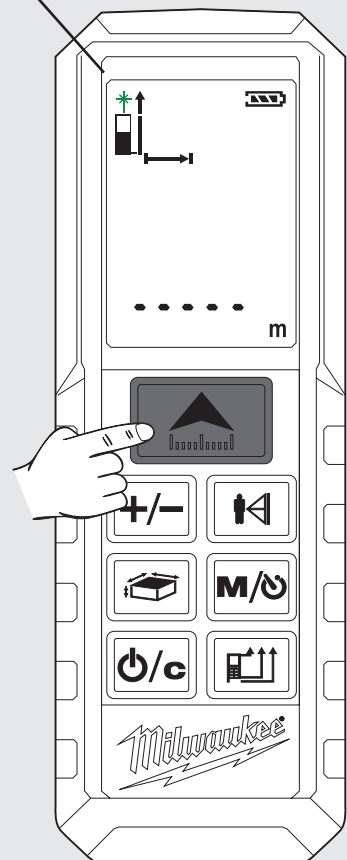

6 Εμφάνιση αποθηκευμένων τιμών

Πιέστε το πλήκτρο **M/0** για 2 δευτερόλεπτα.

Πιέστε επανειλημμένα το πλήκτρο **M/0**

- Οι αποθηκευμένες τιμές εμφανίζονται στην κύρια γραμμή.

- Εμφανίζεται το αντίστοιχο σύμβολο και το μέγεθος μέτρησης αναβοσβήνει (στην εικόνα το πράσινο σύμβολο)

7 Έξοδος από την μνήμη

Πιέστε το πλήκτρο **0/c**

8 Απενεργοποίηση

Πιέστε το πλήκτρο **0/c** για 2 δευτερόλεπτα
(Πριν αυτού πρέπει να έχετε βγει από την λειτουργία μνήμης)

- Η συσκευή σβήνει.

- Αν δεν πιέσετε κάποιο πλήκτρο για 3 λεπτά, η συσκευή απενεργοποιείται αυτόματα.

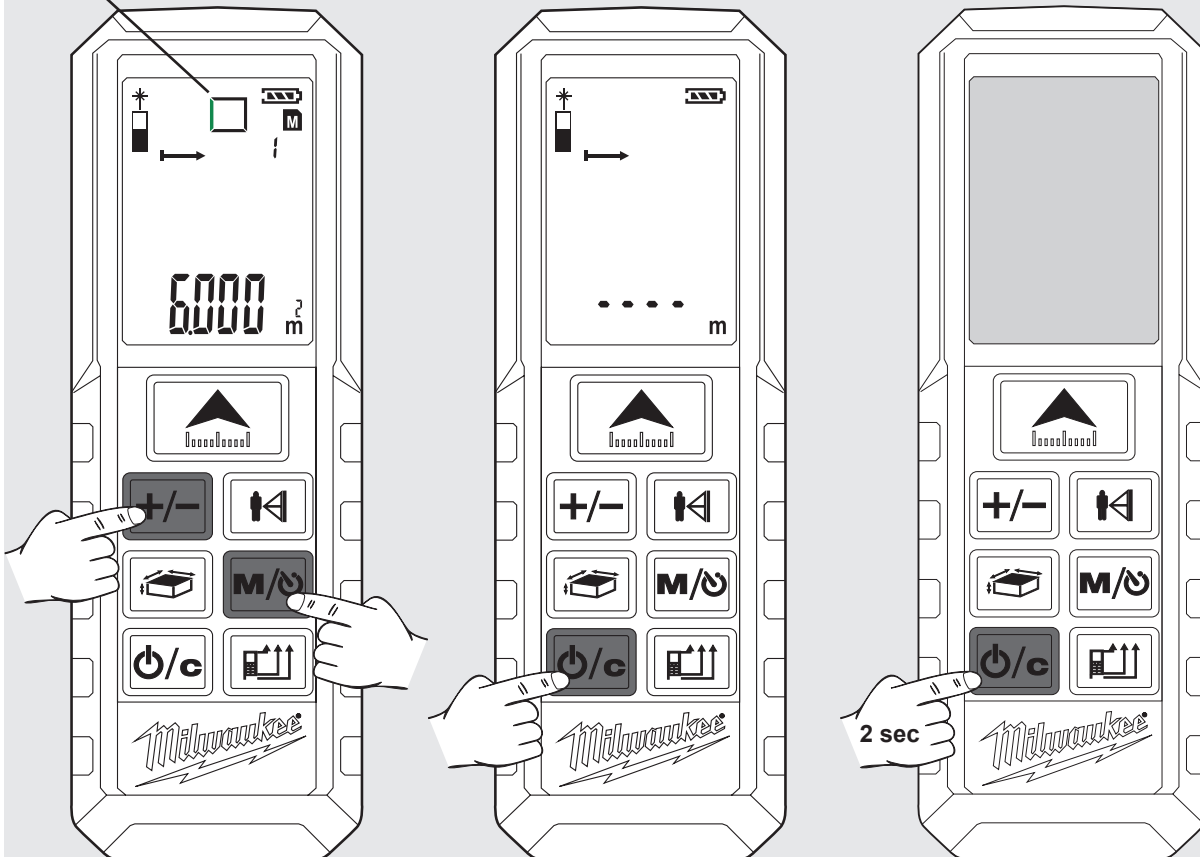

İÇİNDEKİLER

Önemli Emniyet Talimatnamesi	1
Teknik veriler.....	2
Kullanım.....	2
Hata Kodu Tablosu	2
Genel Bakış	3
Pillerin değiştirilmesi	4
Köşe Pimi	4
Kemer Klipsi	4
Fonksiyon Düğmesi, Pisagor, Ölçüm Referansı	5
Münferit Mesafe Ölçümü	6
Sürekli / Minimum-Maksimum Ölçüm	7
Eklemeli / Çıkarmalı Ölçüm	8
Alan Ölçümü	9
Hacim Ölçümü	10
Dolaylı Ölçüm (Pisagor 1).....	11
Dolaylı Ölçüm (Pisagor 2).....	12
Dolaylı Ölçüm (Pisagor 3).....	13
Duvar Alanı Ölçümü (Senaryo 1).....	14
Duvar Alanı Ölçümü (Senaryo 2).....	15
Zamanlayıcı	16
Bellek.....	16
Alan ölçümü örneği (1) ile ilgili Temel Açıklama.....	17
Alan ölçümü örneği (2) ile ilgili Temel Açıklama.....	18

ÖNEMLİ EMNİYET TALİMATNAMESİ



Ürünle birlikte verilen CD'deki Emniyet talimatnamesini ve Kullanma kılavuzunu okumadan önce ürünü kullanmayın.

Lazer Sınıfı

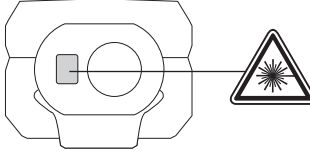

İKAZ:

Bu ürün, EN60825-1:2014 standardına göre, **Sınıf 2** lazer kategorisine girer.

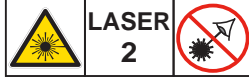

λ 650 nm P<1 mW

Uyarı:

Doğrudan ışına bakmayınız. Lazer ışını ışık körlüğüne yol açabilir.

Gözünüzü, gereksiz yere lazer ışınına dikmeyiniz ve bu ışınları başkalarının üzerine tutmayınız.

Diğer şahıslara yöneltmeyin.

Uyarı:

Lazer cihazını çocukların yakınında kullanmayın veya çocukların lazer cihazını kullanmalarına izin vermeyin.

Dikkat! Yansıma yapan bir yüzey lazer ışını kullanıcıya veya başka kişilere geri yansıtabilir.

Dönen parçalarla aranızda emniyetli bir mesafe bulundurun.

Periyodik olarak denetleme ölçümleri yapın. Özellikle, önemli ölçümleri yapmadan önce, yaparken ve yaptıktan sonra.

Cihazın düşürülmesinden veya uygun olmayan alanda kullanılmasından ya da üzerinde yapılan değişiklikten kaynaklanan bir arıza sebebiyle, hatalı ölçümlerden sakınız.

Uyarı: Kumanda elemanlarının kullanılması, el kitabında tespit edilmiş yöntemlerden farklı yöntemlerin veya ayarların uygulanması tehlikeli ışınımın oluşmasına neden olabilir.

Lazerli mesafe ölçerin kullanımıyla ilgili sınırlar vardır. (Bkz. "Teknik Veriler" bölümü). Maksimum ve minimum aralık dışındaki ölçüm denemeleri yanlış sonuçlara neden olacaktır. Çok sıcak, çok soğuk, çok parlak güneş ışığı, yağmur, kar, sis veya diğer görüşü kısıtlayan koşullar gibi olumsuz koşullarda kullanım, yanlış ölçüm değerlerinin elde edilmesine yol açacaktır.

Lazerli mesafe ölçer çok soğuk koşullardan sıcak bir ortama getirilirse veya tam tersi bir durumda, kullanımdan önce cihaz ortam sıcaklığına gelene kadar bekleyiniz.

Lazerli mesafe ölçeri daima kapalı ortamda saklayınız, cihazı şok, sürekli titreşim veya aşırı sıcaklıklara maruz bırakmayınız.

Aleti daima toz, sıvılar ve yüksek nem koşullarından uzakta tutunuz. Bunlar, iç bileşenlere zarar verebilir veya doğruluk hassasiyetini etkileyebilir.

Aşındırıcı temizlik maddeleri veya çözeltilerini kullanmayınız. Temizlik için yalnızca temiz, yumuşak bir bez kullanınız.

Ölçüm aletinin ağır bir darbeye uğramasını veya yere düşmesini önleyiniz. Cihaz yere düşürülmüşse veya diğer mekanik gerilimlere maruz kalmışsa, kullanımdan önce aletin doğruluğu kontrol edilmelidir.

Bu lazer cihazında gerekli olan tamirler sadece yetkili servis personeli tarafından yapılabilir.

Agresif veya patlayıcı ortamlarda çalıştırmayın.

Bataryaları şarj etmek için sadece imalatçı tarafından önerilen şarj cihazını kullanın.



Atık pillerin, atık elektrikli ve elektronik eşyaların evsel atıklarla birlikte bertaraf edilmesi yasaktır. Atık piller, atık elektrikli ve elektronik eşyalar ayrılarak biriktirilmeli ve bertaraf edilmelidirler.

Bertaraf etmeden önce cihazların içindeki atık pilleri, atık akümülatörleri ve lambaları çıkartınız.

Yerel makamlara veya satıcınıza geri dönüşüm tesisleri ve atık toplama merkezlerinin yerlerini danışınız.

Yerel yönetmeliklere göre perakende satıcılar atık pilleri, atık elektrikli ve elektronik eşyaları ücret talep etmeden geri almak zorunda olabilirler.

Atık pillerinizi, atık elektrikli ve elektronik eşyalarınızı tekrar kullanarak ve geri dönüşüme vererek ham madde gereksiniminin az tutulmasına katkıda bulununuz.

Atık piller (özellikle lityum iyon piller), atık elektrikli ve elektronik eşyalar, çevreye uygun şekilde bertaraf edilmediklerinde çevre ve sağlığınız üzerinde olumsuz etkilere neden olabilen değerli, tekrar kullanılabilir malzemeler içerirler.

Bertaraf etmeden önce atık eşyanız içinde mevcut olabilen şahsınızla ilgili bilgileri siliniz.

 Avrupa uyumluluk işareti

 Britanya Uygunluk İşareti

 Ukrayna uyumluluk işareti

 Avrasya uyumluluk işareti

TEKNİK VERİLER

Toz ve Su direnci	IP54
Alıcı Mercekler	14 mm
Odak noktası	35 mm
Maksimum Ölçüm Aralığı	50 metre (Tolerans: 55m)
Minimum Ölçüm Aralığı	0.05 metre
< 10m'de Mutlak Ölçüm Hassasiyeti	± 1.5 mm (Maks.)
< 10m'de Tekrar Elde Edilebilir Hassasiyet	± 1.5 mm (Maks. Tipik 2σ)
> 10m'de Tekrar Elde Edilebilir Hassasiyet	Artış ± 0.25 mm / metre (Maks. Tipik 2σ)
Ölçme Süresi	0.5 sn.
Ekran Tipi	LCD (22.7 mm x 31 mm)
Güç Türü	AAA 2x (Kalem PİL)
Pil Ömrü	10000 (Münferit Ölçüm)
Lazer Çıkış Gücü	0.6 mW ~ 0.95 mW (Sınıfı 2, 650nm)
Lazer Hedef Noktası Büyüklüğü	25 x 30 mm @ 16 m (Maks.)
Lazer sınıfı	2
Lazer tipi	650 nm, < 1 mW
Lazer Işınımı Düşey Açısı	+1 derece
Lazer Işınımı Yatay Açısı	± 1 derece
Cihazın otomatik kapanma süresi	180 saniye
Lazerin otomatik kapanma süresi	30 saniye
Çalışma Sıcaklığı Aralığı	-10°C ila +50°C
Saklama Sıcaklığı Aralığı	-25°C ila +70°C
Pilsiz Ağırlığı	80 g

KULLANIM

Lazerli mesafe ölçer, uzaklıklar ve eğimlerin ölçümü için kullanılabilir.
Bu alet sadece belirtildiği gibi ve usulüne uygun olarak kullanılabilir.

HATA KODU TABLOSU

Kod	Tanım	Çözüm
Hata01	Ölçüm aralığı dışında	Uygun bir aralıkta ölçüm yapın
Hata02	Alınan sinyal çok zayıf	Daha iyi bir yüzey seçin
Hata03	Görüntüleme aralığı dışında(maks. değer: 99.999) yani alan veya hacim sonucu ekranda görüntülenemiyor	Değerlerin ve adımları kontrol edin ve doğru olduklarından emin olun
Hata04	Pisagor hesaplama hatası	Değerler ve adımları kontrol edin ve doğru olduklarından emin olun
Hata05	Pil zayıf	Yeni piller takın
Hata06	Çalışma sıcaklığı dışında	Belirtilen çalışma sıcaklığındaki bir ortamda ölçüm yapın
Hata07	Ortam ışığı çok güçlü	Daha karanlık bir yerde ölçüm yapın (hedefe gölge yapın)

Pisagor
Yükseklik farkı

Ölçüm Referansı

Normal Ölçüm Modu

Sürekli Ölçüm için Minimum / Maksimum

Ekleme / Çıkarma

AÇIK / ÖLÇÜM

- ▶ Açık
- ▶ Ölçüm
- ▶ Sürekli Ölçüm (2 sn basın)
+ Min / Maks. Fonksiyonu

EKLE / ÇIKAR

- ▶ Değer ekle
- ▶ Bellek menüsünde gezin

ALANLAR / HACİMLER

- ▶ Alan (1 kez basın)
- ▶ Hacim (2 kez basın)
- ▶ Dolaylı Yüzey Ölçümü (3 kez / 4 kez basın)

GÜÇ

- ▶ Açık
- ▶ Kapalı (2 sn basın)
- ▶ Sil

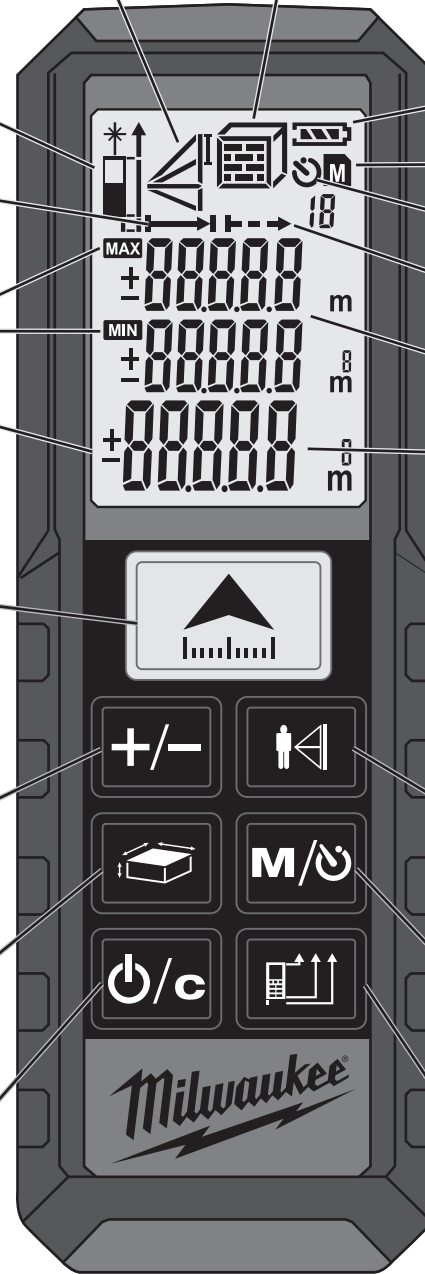

Alan/ Hacim
Dolaylı Yüzey Ölçümü

Pil Durumu

Bellek

Zamanlayıcı

Sürekli ölçüm modu

Değerler Arası

Ana Değer

PISAGOR

- ▶ Pisagor 1 (1 kez basın)
- ▶ Pisagor 2 (2 kez basın)
- ▶ Pisagor 3 (3 kez basın)

BELLEK

- ▶ Zamanlayıcı 3-15 sn (1 kez basın)
- ▶ Bellek 1-20 (1 kez, 2 sn basın)
- ▶ Kaydedilen değerlerin açılması (tekrar basınız)

ÖLÇÜM NOKTASINI DEĞİŞTİR

- ▶ Ön
- ▶ Arka (Standart otomatik)
- ▶ Köşe pimi

PİLLERİN DEĞİŞTİRİLMESİ

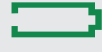
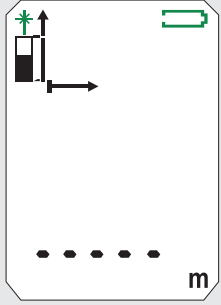

Pil işareti yanıp söndüğünde pilleri değiştirin.

1

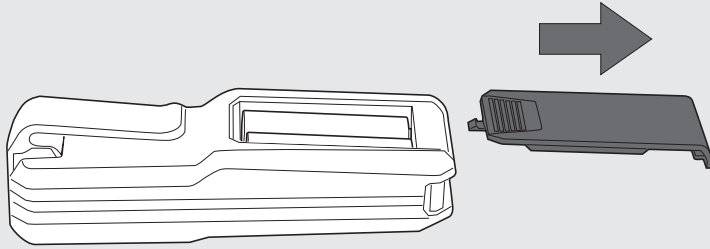

2

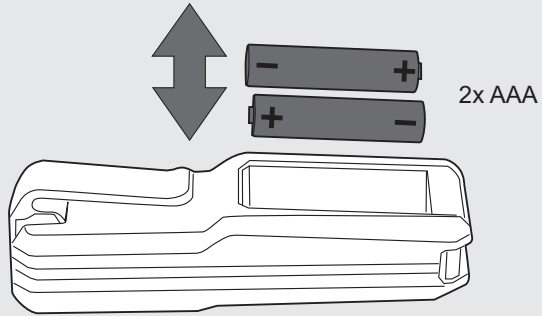

3

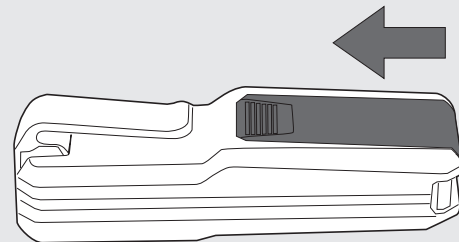

KOŞE PİMİ

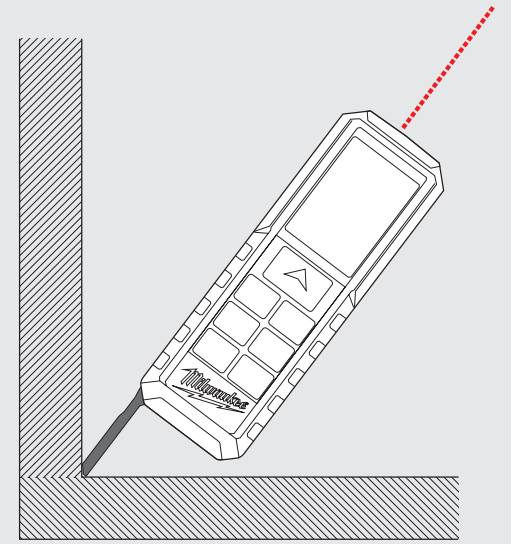
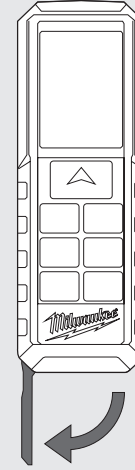

KEMER KLİPSİ

1

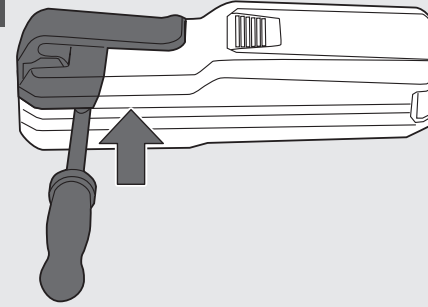

2

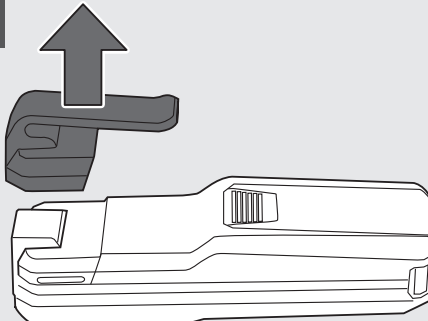

3

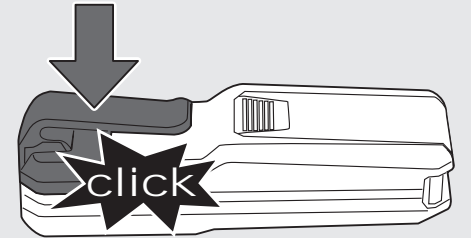

FONKSİYON DÜĞMESİ, PISAGOR, ÖLÇÜM REFERANSI

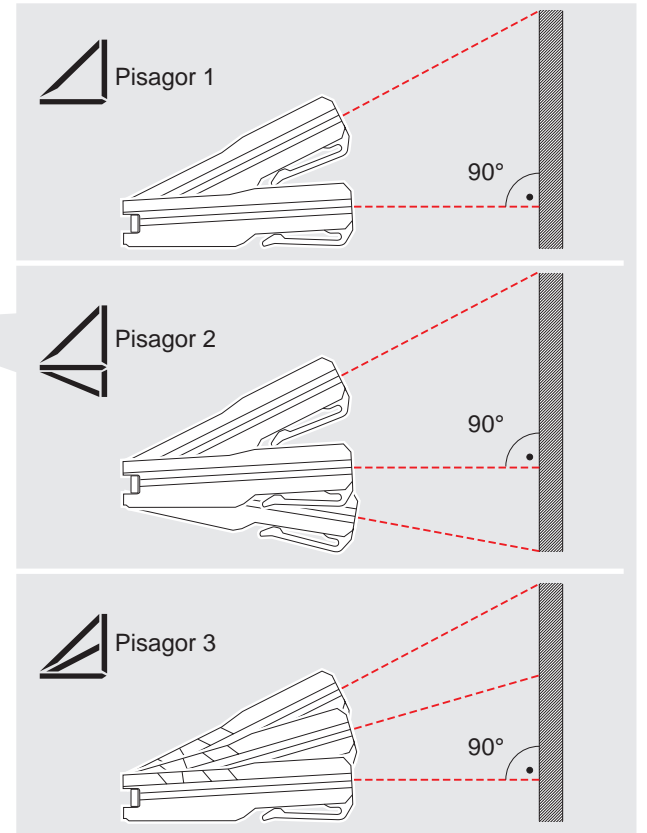
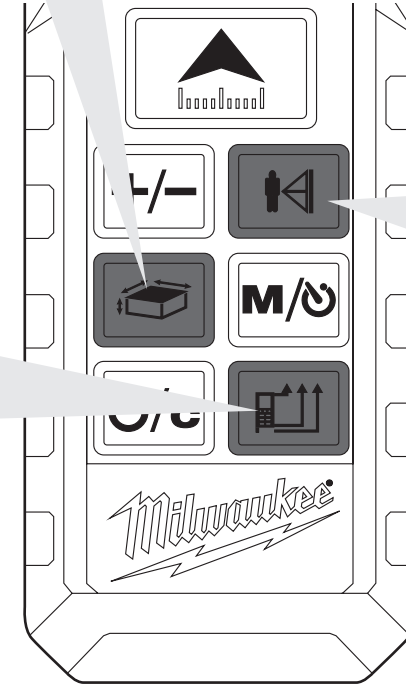
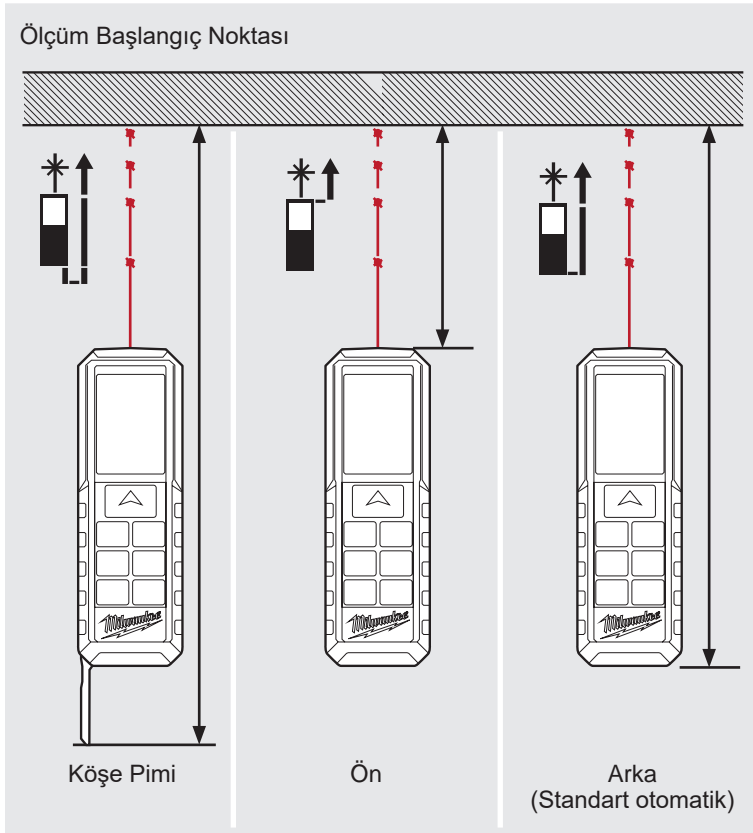
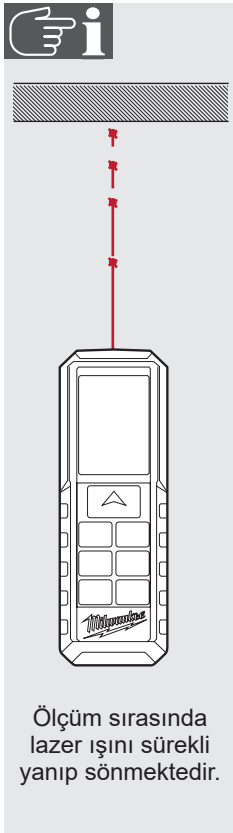
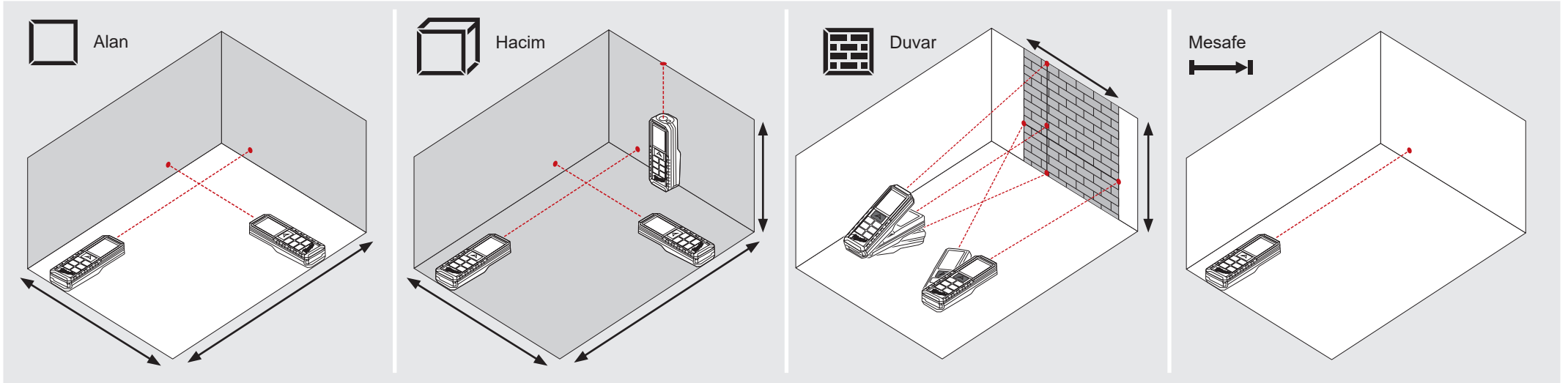

MÜNFERIT MESAFE ÖLÇÜMÜ

0

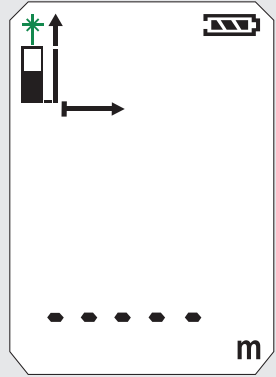

1

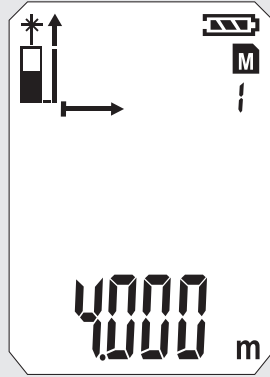

2

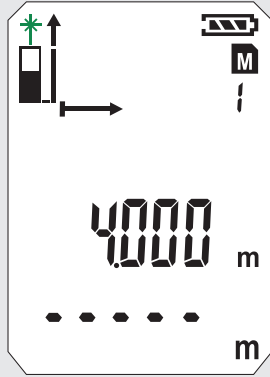

3

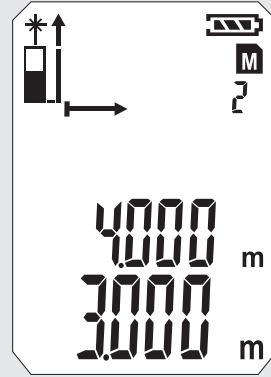

4

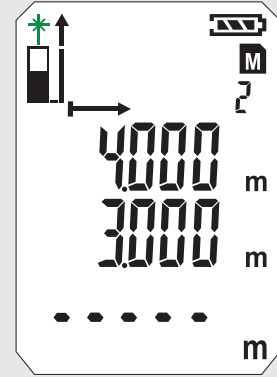

5

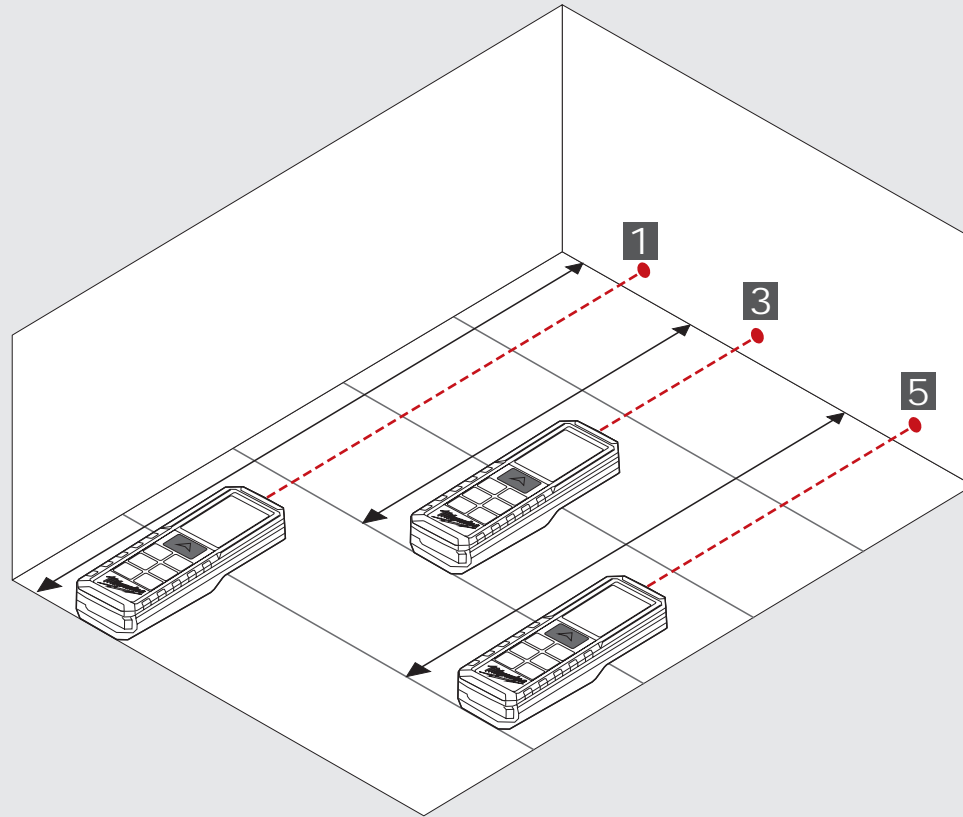
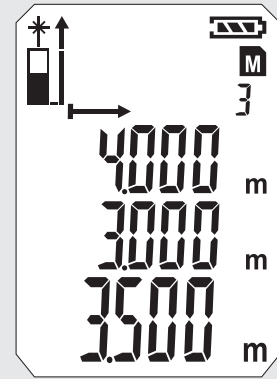

SÜREKLİ / MINIMUM-MAKSİMUM ÖLÇÜM

0

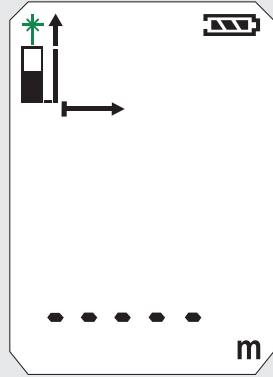

1

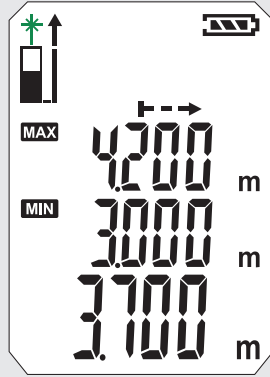

2

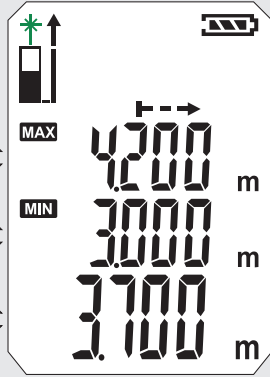

3

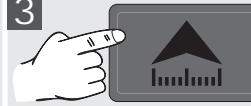

Stop
MIN / MAX

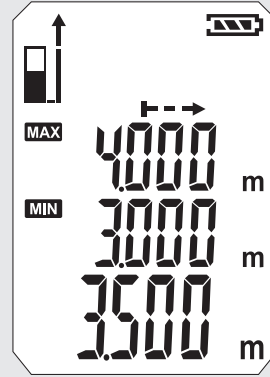

4

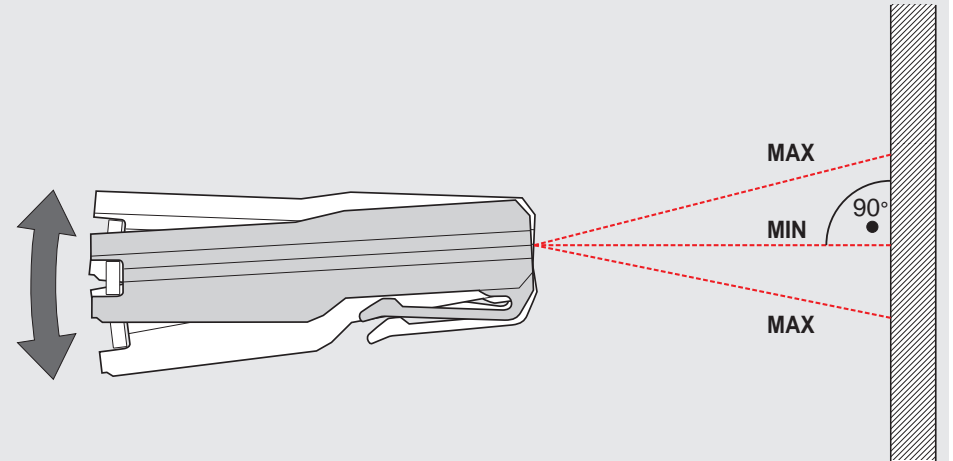
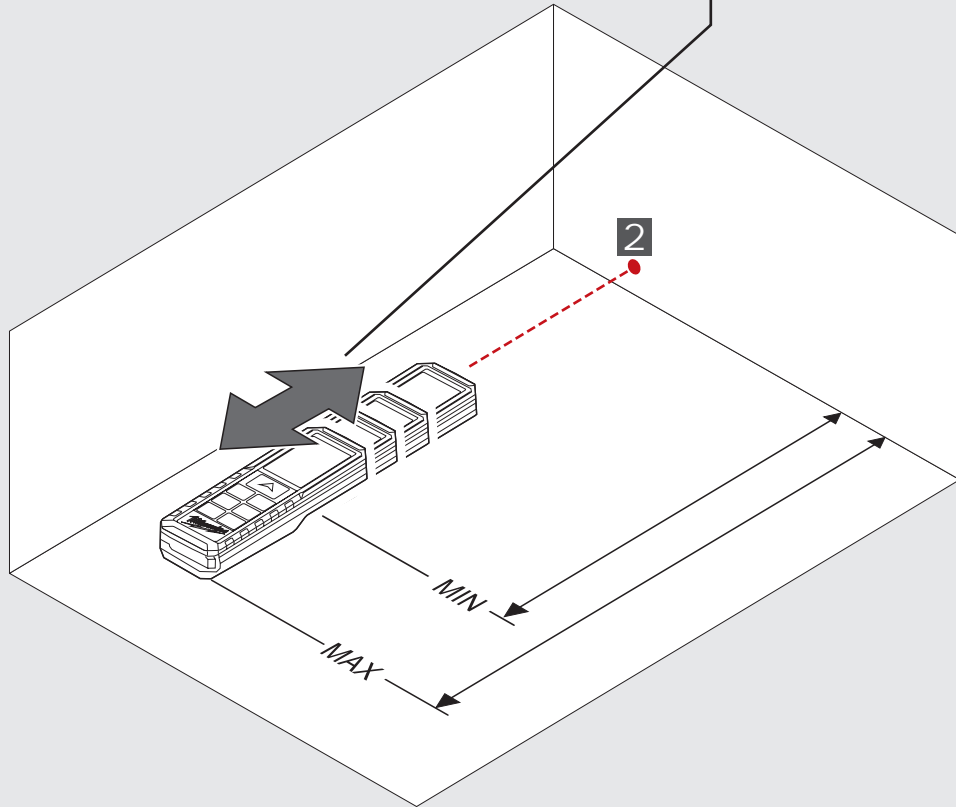
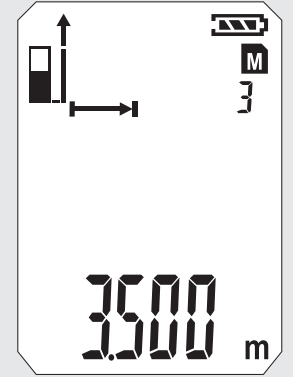

0

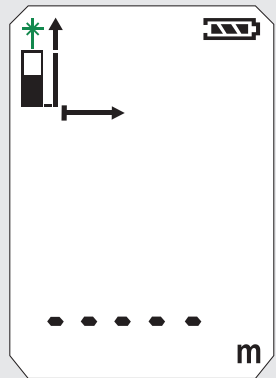

1

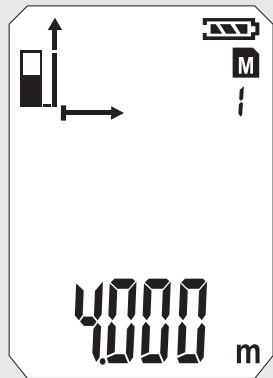

2

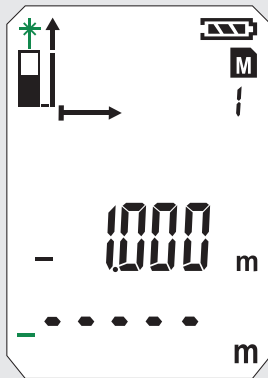

3

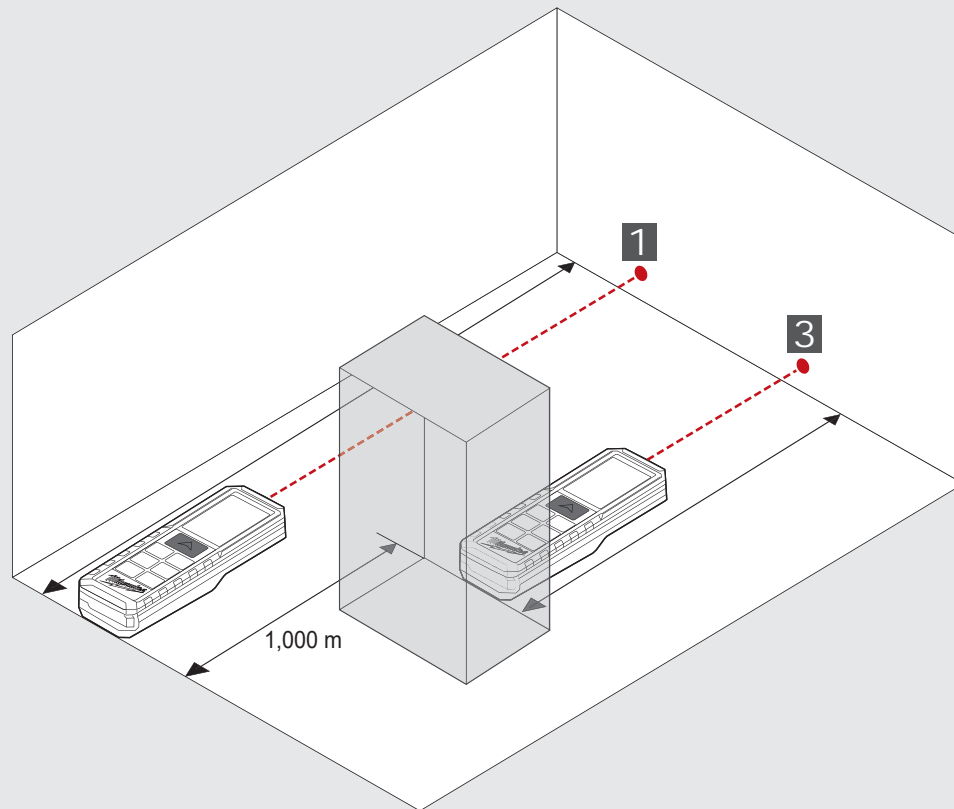
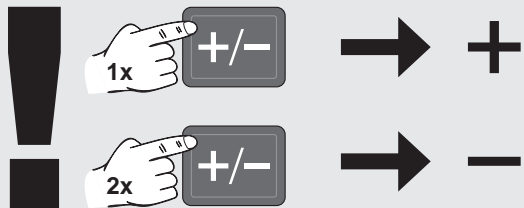
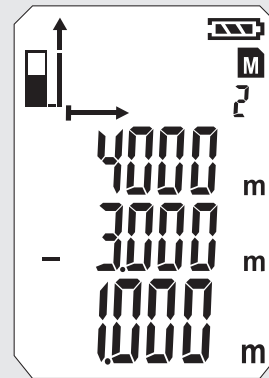

ALAN ÖLÇÜMÜ

0



1



2

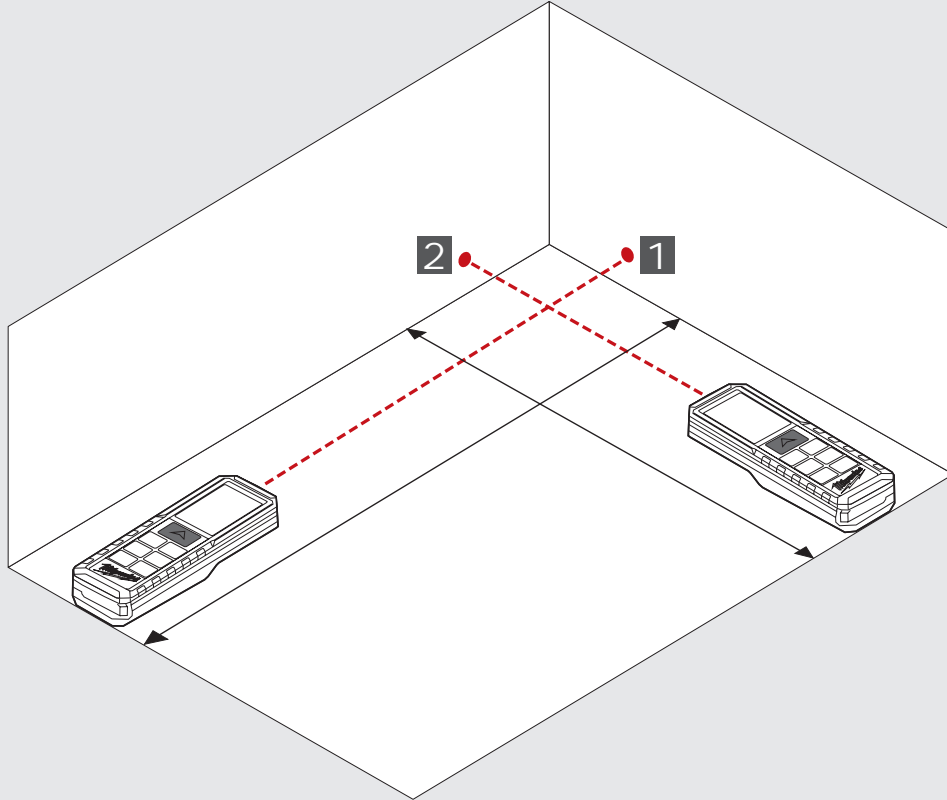
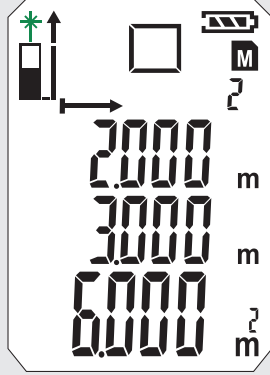
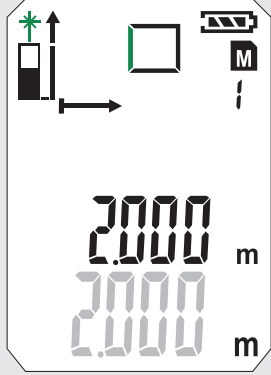
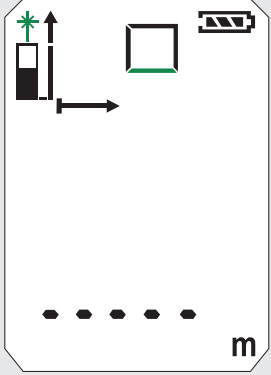

HACİM ÖLÇÜMÜ

0



1



2



3

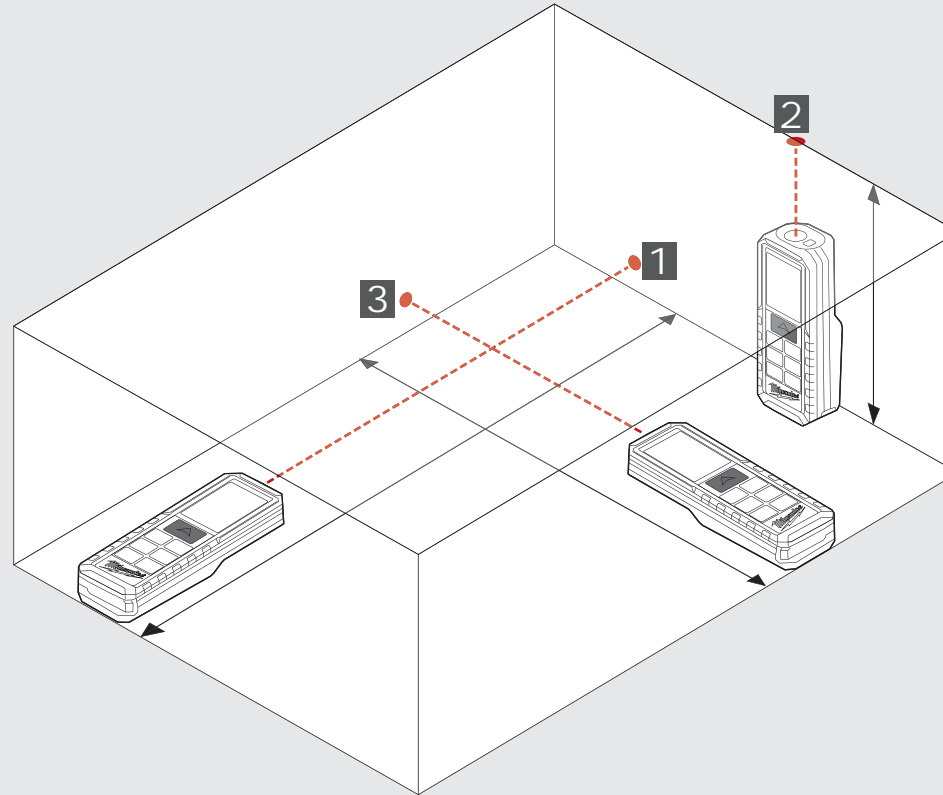
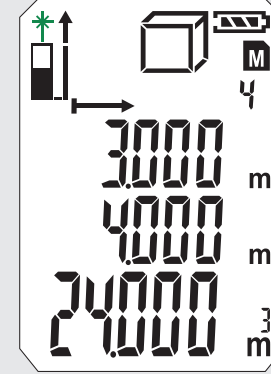
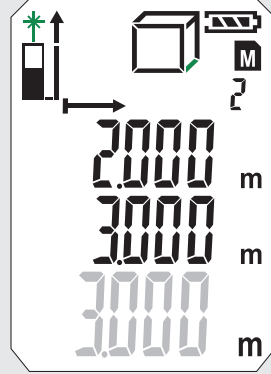
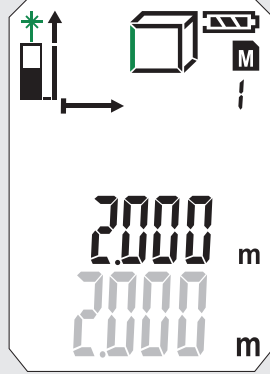
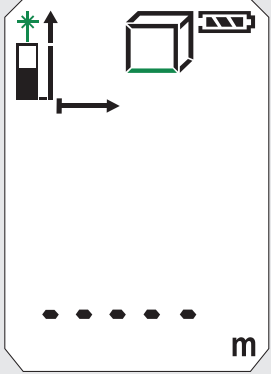

DOLAYLI ÖLÇÜM (PISAGOR 1)

0



1



2

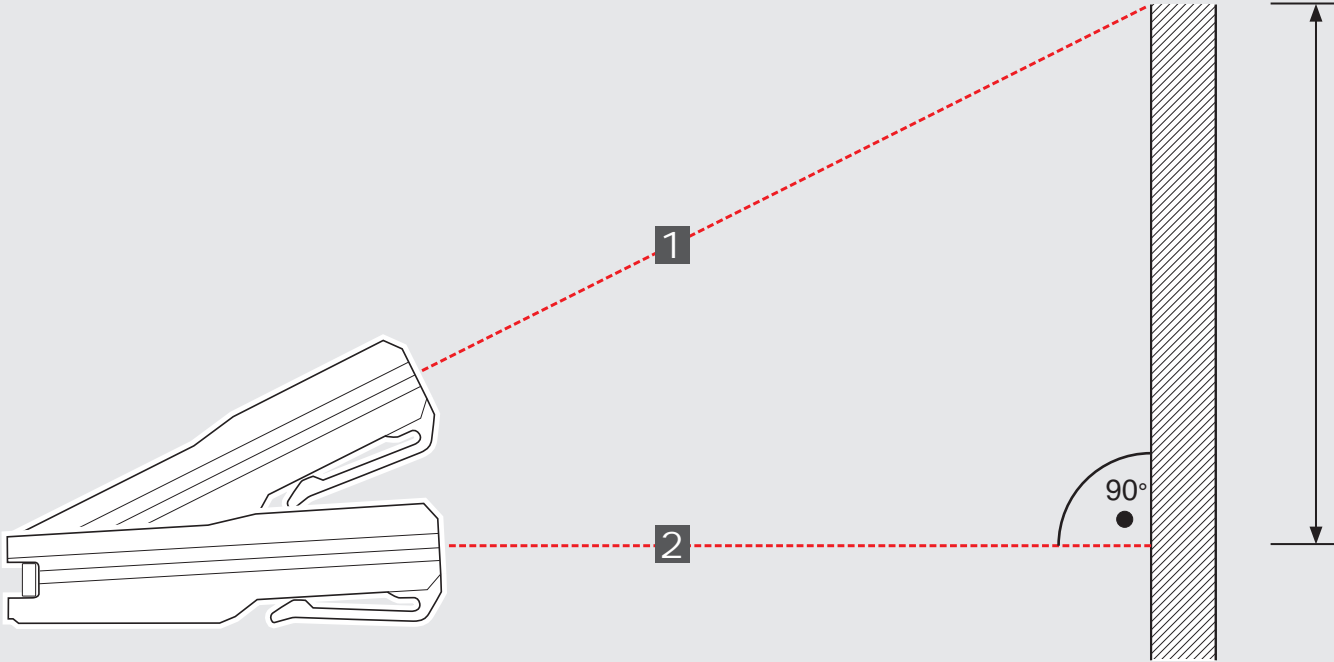
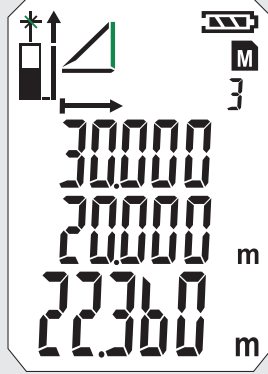
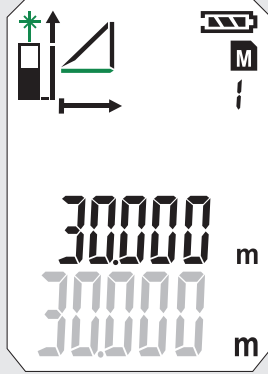
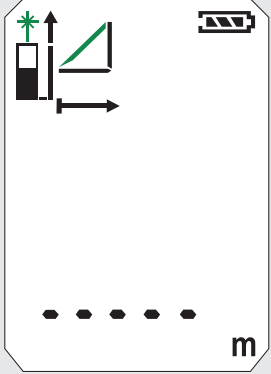

DOLAYLI ÖLÇÜM (PISAGOR 2)

0

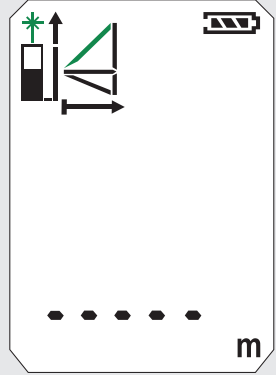

1

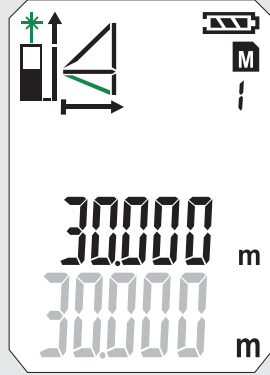

2

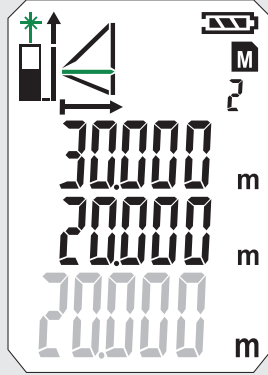

3

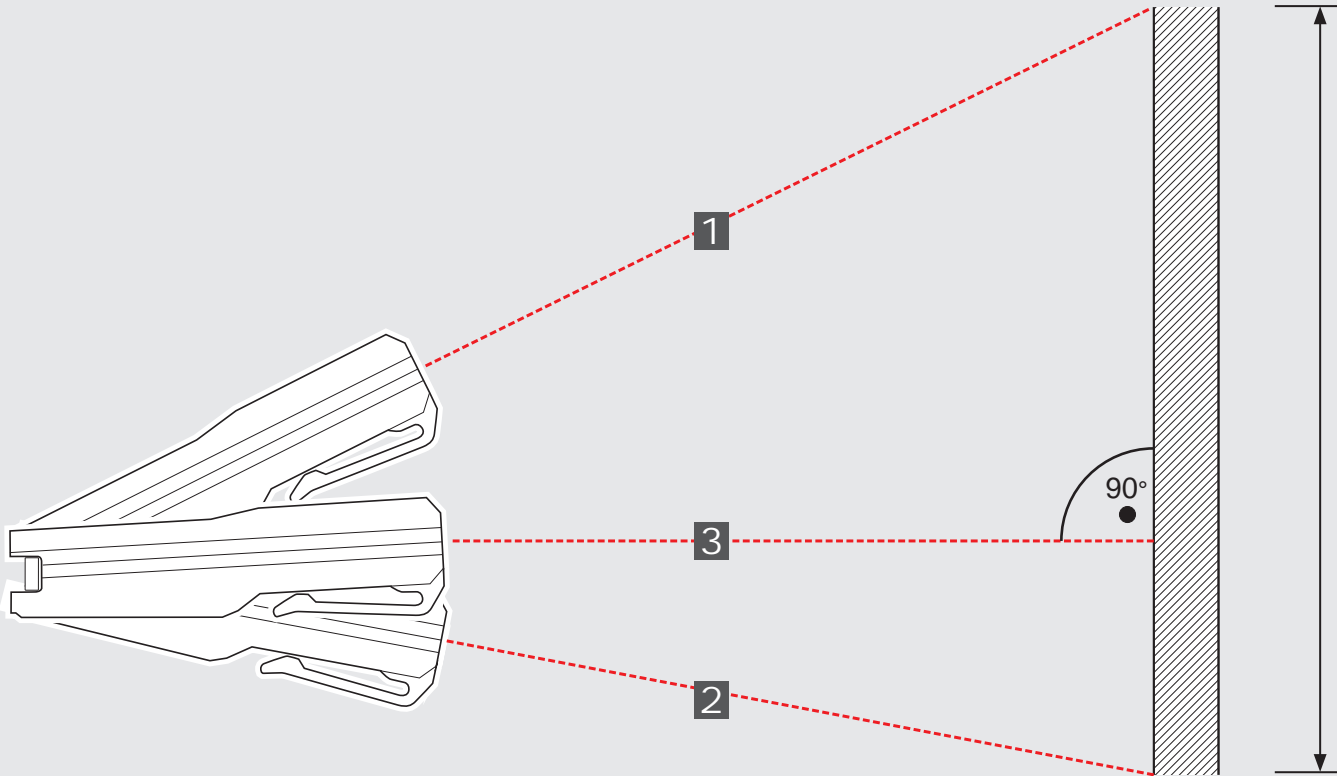
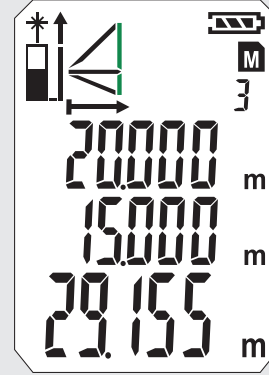

DOLAYLI ÖLÇÜM (PISAGOR 3)

1



2







3

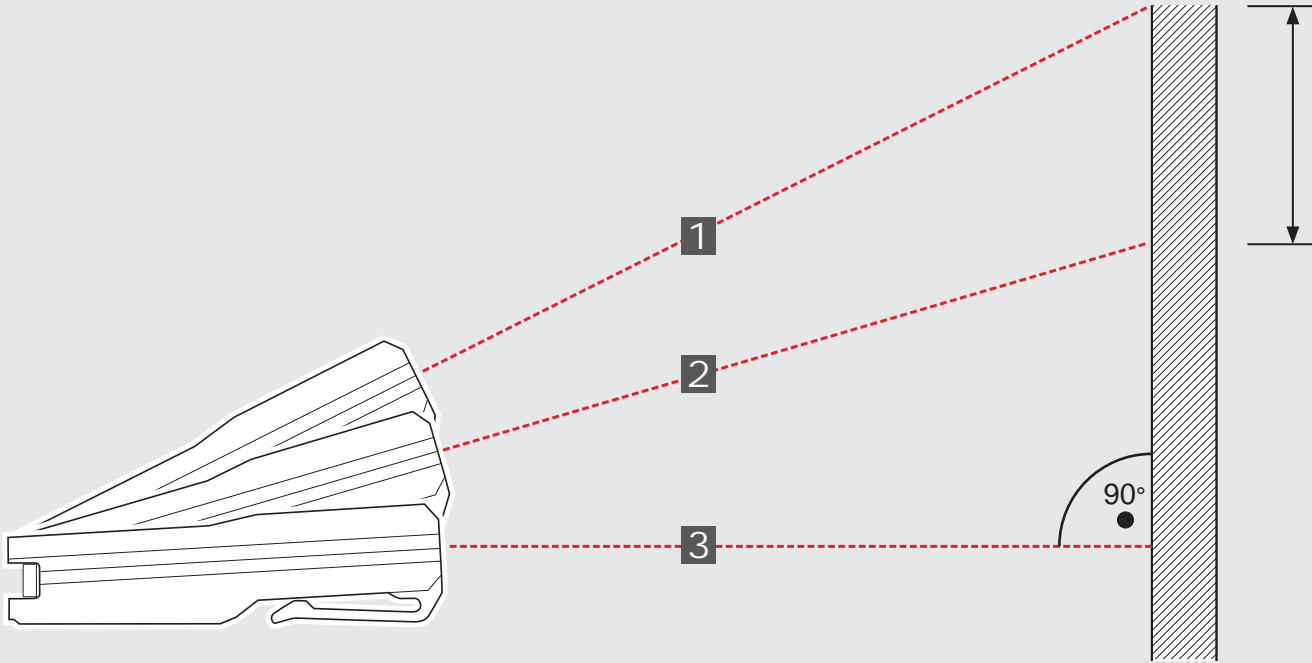
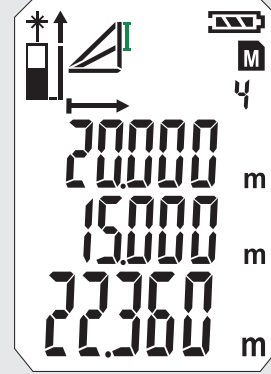
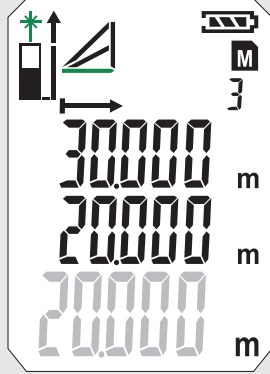
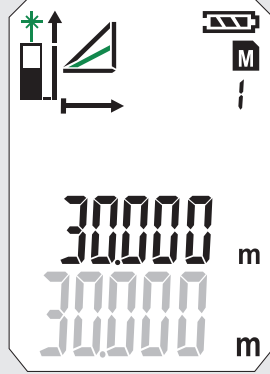
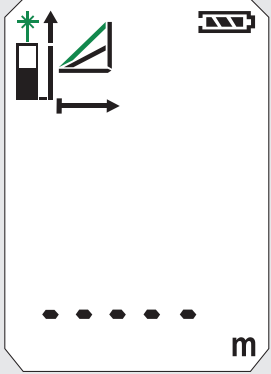

4

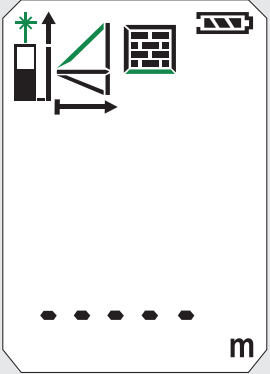
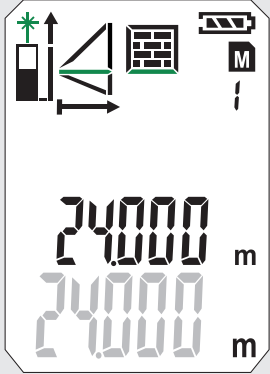
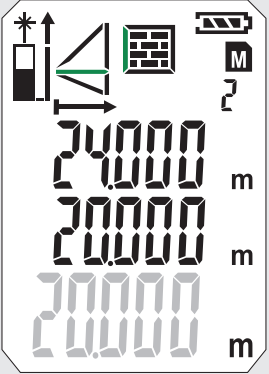
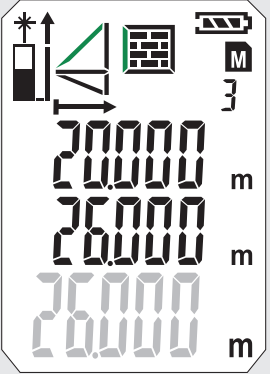
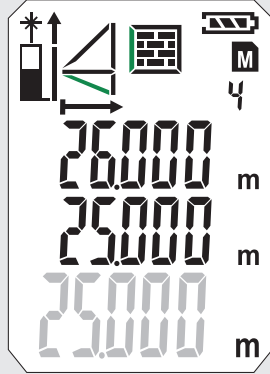

DUVAR ALANI ÖLÇÜMÜ (SENARYO 1)

0	1	2	3	4
				
				

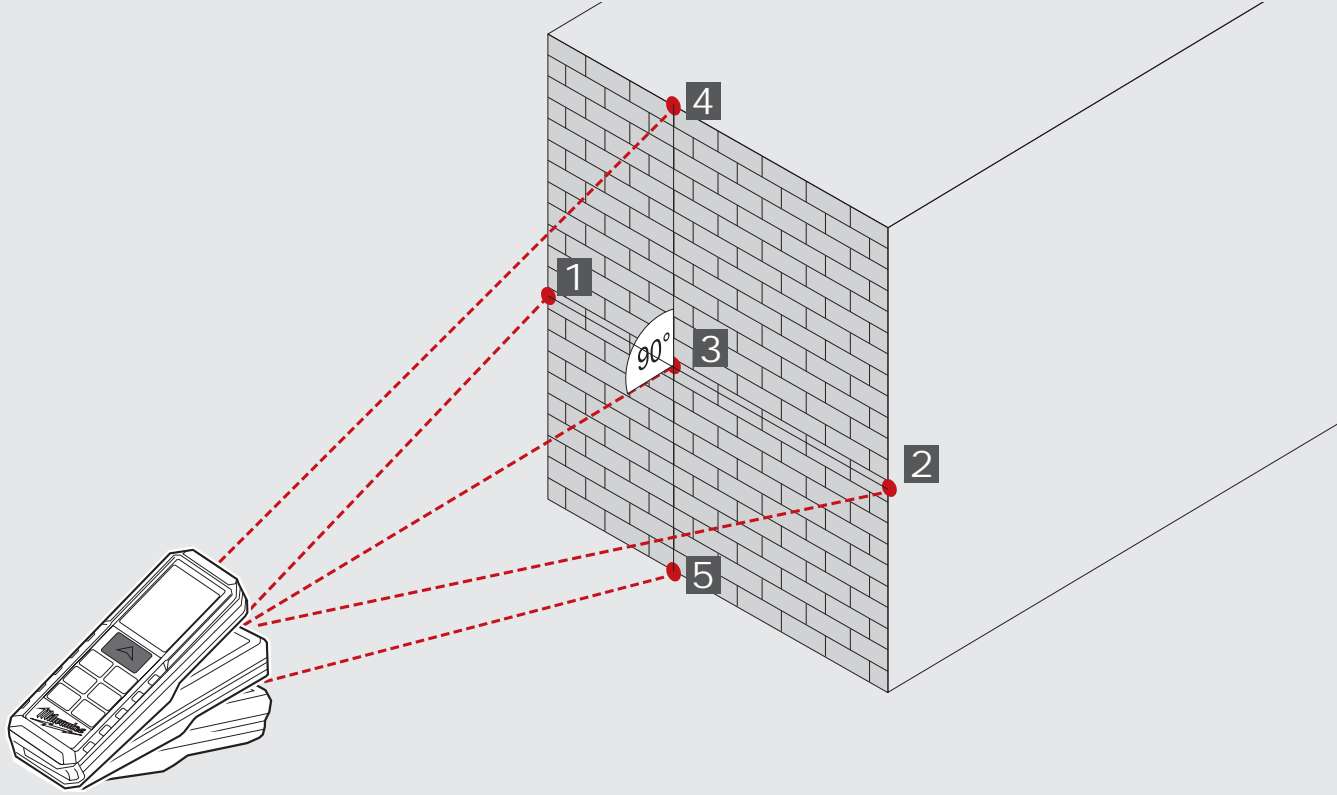
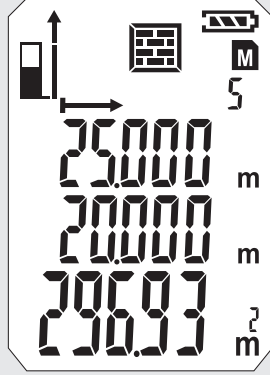

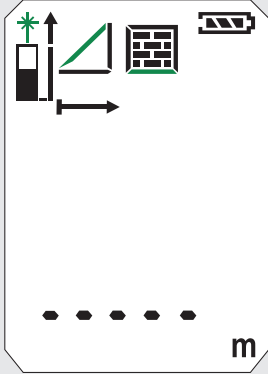

DUVAR ALANI ÖLÇÜMÜ (SENARYO 2)

0

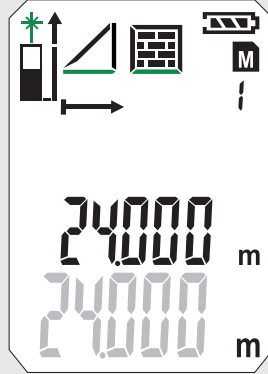

1



2

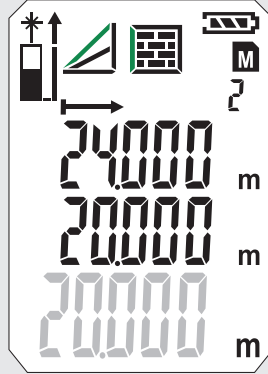

3

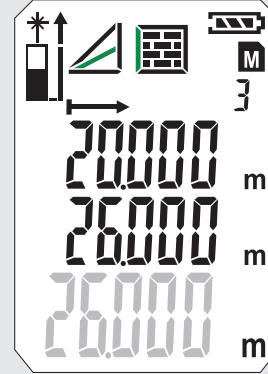

4

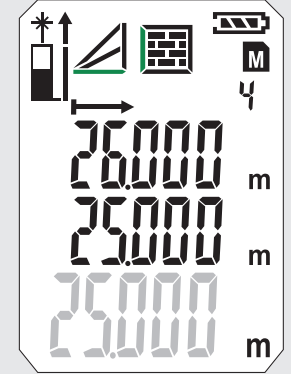

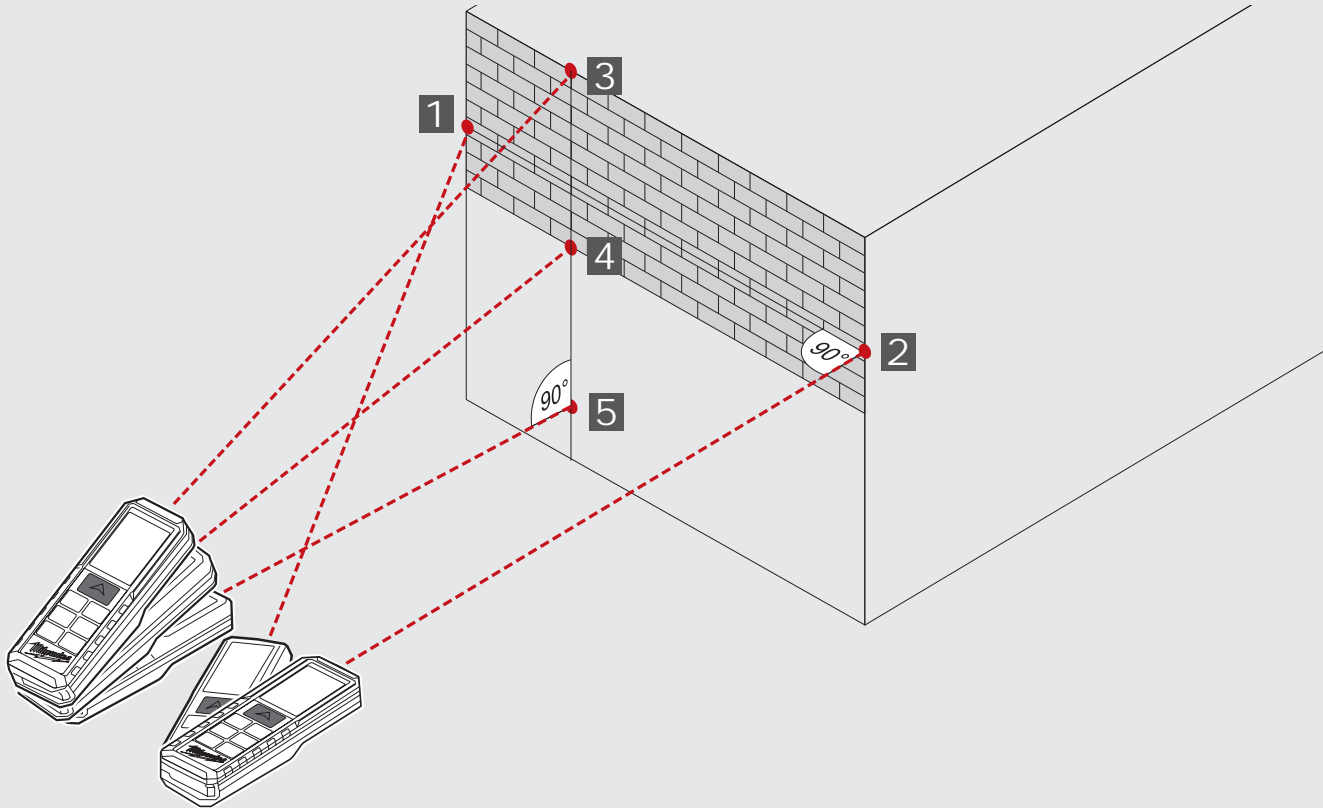
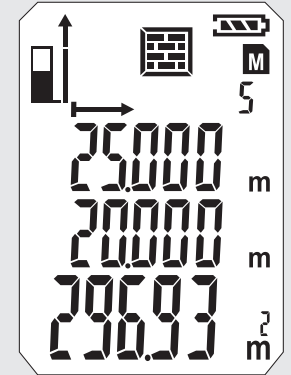

5



ZAMANLAYICI

Zamanlayıcı ile ölçüm geç başlatılabilir. Örneğin, ölçüm ışınına bir parçanın yerleştirilmesi için.

 (bellek) düğmesine bas

- Simge görüntülenir. Zamanlayıcı,  düğmesine basılarak, 3 ila 15 sn aralığında ayarlanabilir.

 düğmesine bas

- Ölçüm başlayana kadar saniyeler geriye doğru sayılır.
- 0'da ölçüm başlar.

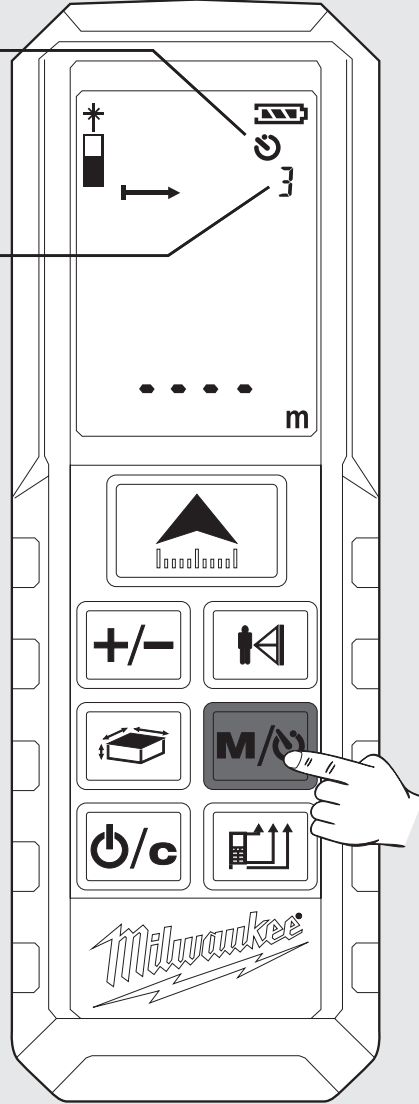

BELLEK

Ölçülen değerler, sürekli ve otomatik olarak bellekte kaydedilir. Kaydedilen değerlere  (bellek) düğmesine basılarak ulaşılabilir.

 (bellek) düğmesine 2 sn basın.

- Simge ve bellek sayısı ekranda görünür.
- İlişkili ölçülmüş parametre gösterilir.
- Kaydedilmiş değer, ana satırda gösterilir.
- Kaydedilen değerleri  tuşuna tekrar basarak açınız.

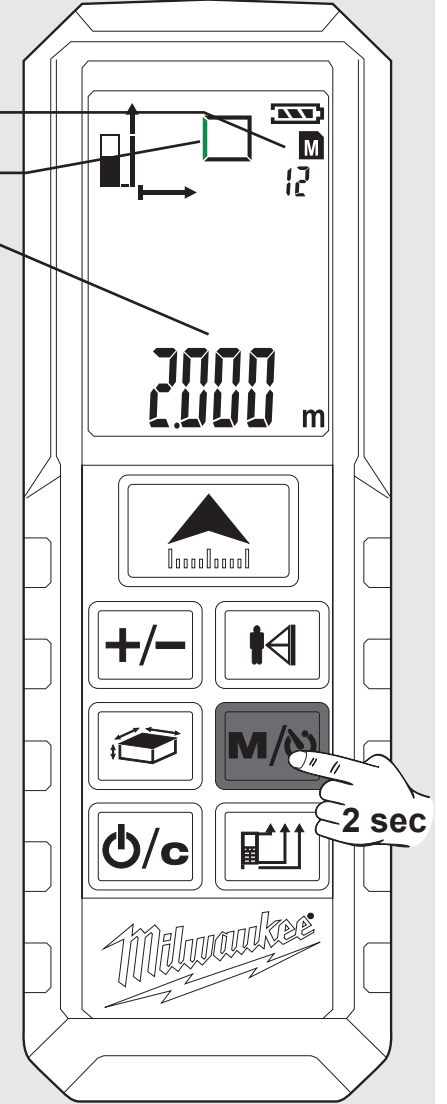

ALAN ÖLÇÜMÜ ÖRNEĞİ (1) İLE İLGİLİ TEMEL AÇIKLAMA

1 Cihazı Aç

Düğmesine bas
⚠ Dikkat! Lazer açık!
Başkasına doğrultmayın!

Lazer simgesi yanıp söner
(yanıp sönen yeşil ışıkla
gösterilir).

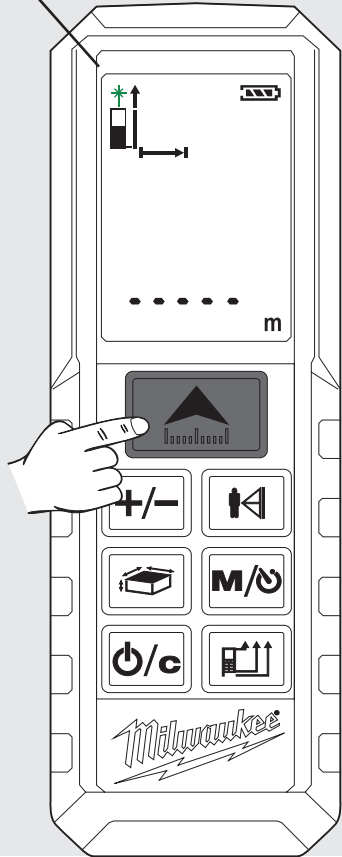

2 Ölçüm Aralığını Seç

Cihazın açılmasından sonra
standart: Alt

1 kez basın -> Köşe Pimi
2 kez basın -> Üst
3 kez basın -> Alt

Simge görüntülenir.

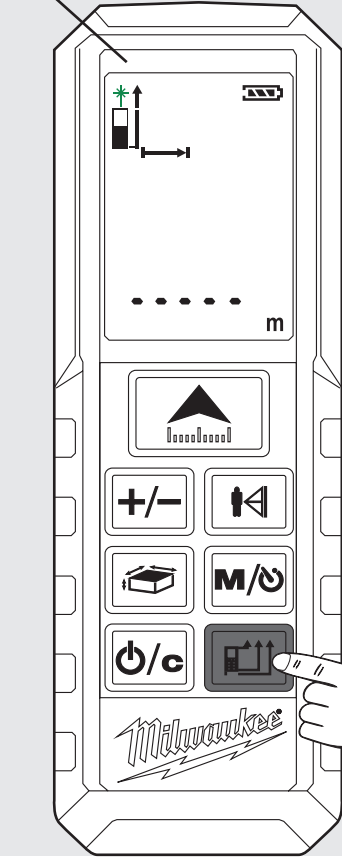

3 Fonksiyonu Seç

Cihaz açıldıktan sonra daima
münferit mesafe ölçümüne ayarlıdır
1 kez basın - Alan Ölçümü.

- Simge görüntülenir.
- Ölçülen parametre yanıp söner
(yanıp sönen yeşil ışıkla gösterilir)

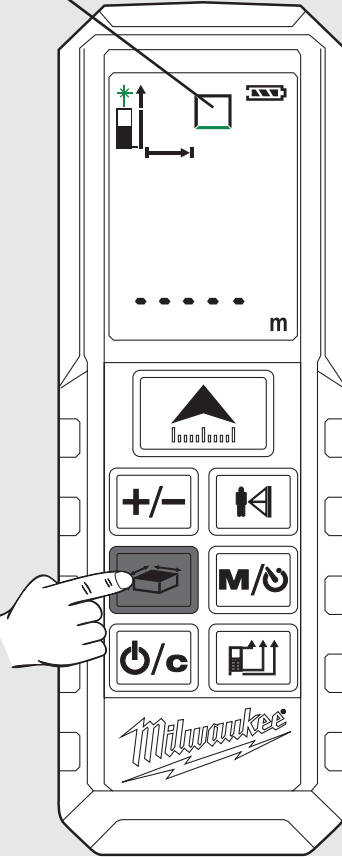

4 Uzunluğu ölç

Cihazı hedefe
doğru yöne ve
düğmesine bas.

- Ölçülen değer kısa bir süre için
ana satırda görüntülenir.
- Ölçülen değer, yukarıdaki satırda
1 saniye atlar.
- Ölçülen değer, ardışık sayılar
halinde belleğe kaydedilir.
- İkinci ölçülen parametre yanıp
söner. Cihaz ikinci değer için
hazırdır.

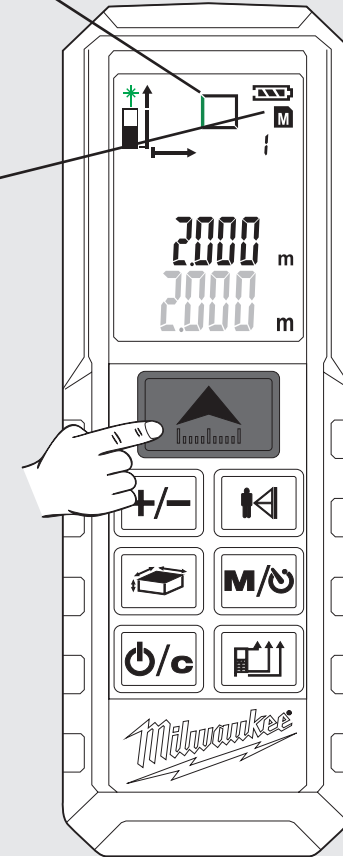

5 Genişliği ölç

Cihazı hedefe doğru
yöne ve
düğmesine bas.

- Ölçülen değer kısa bir süre için alt
satırda görüntülenir.
- Ölçülen değer, yukarıdaki satırda
1 saniye atlar.
- Ölçülen değer, ardışık sayılar
halinde belleğe kaydedilir.
- Sonuç ana satırda görüntülenir ve
ardışık sayılar halinde belleğe
kaydedilir.

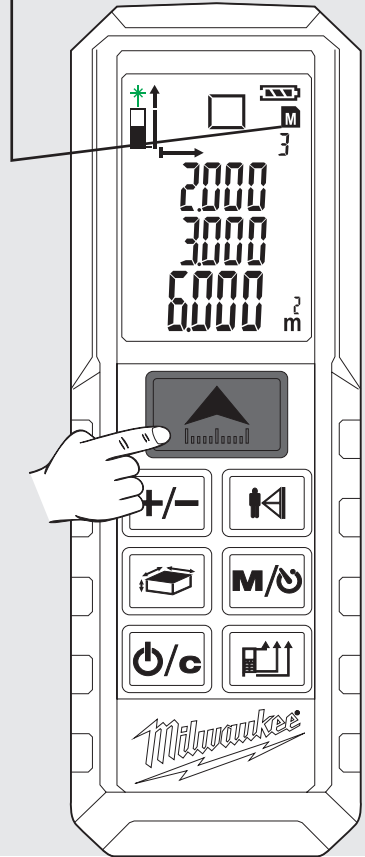

ALAN ÖLÇÜMÜ ÖRNEĞİ (2) İLE İLGİLİ TEMEL AÇIKLAMA

6 Kaydedilen değerleri görüntüle

M/Ö (bellek) düğmesine 2 sn basın.
M/Ö tuşuna tekrar basınız

7 Bellekten çık

Ö/c (güç) düğmesine bas.

8 Cihazı kapat

Ö/c düğmesine 2 sn basın
(Önce bellekten çıkmış olmalısınız)

- Kaydedilmiş değerler, ana satırda gösterilir.
- İlişkili simge ekranda belirir ve ölçülen parametre yanıp söner (yanıp sönen yeşil ışıkla gösterilir)

- Cihaz kapanır.
- Hiçbir düğmeye basılmazsa, cihaz 3 dakika sonra kendiliğinden kapanır.

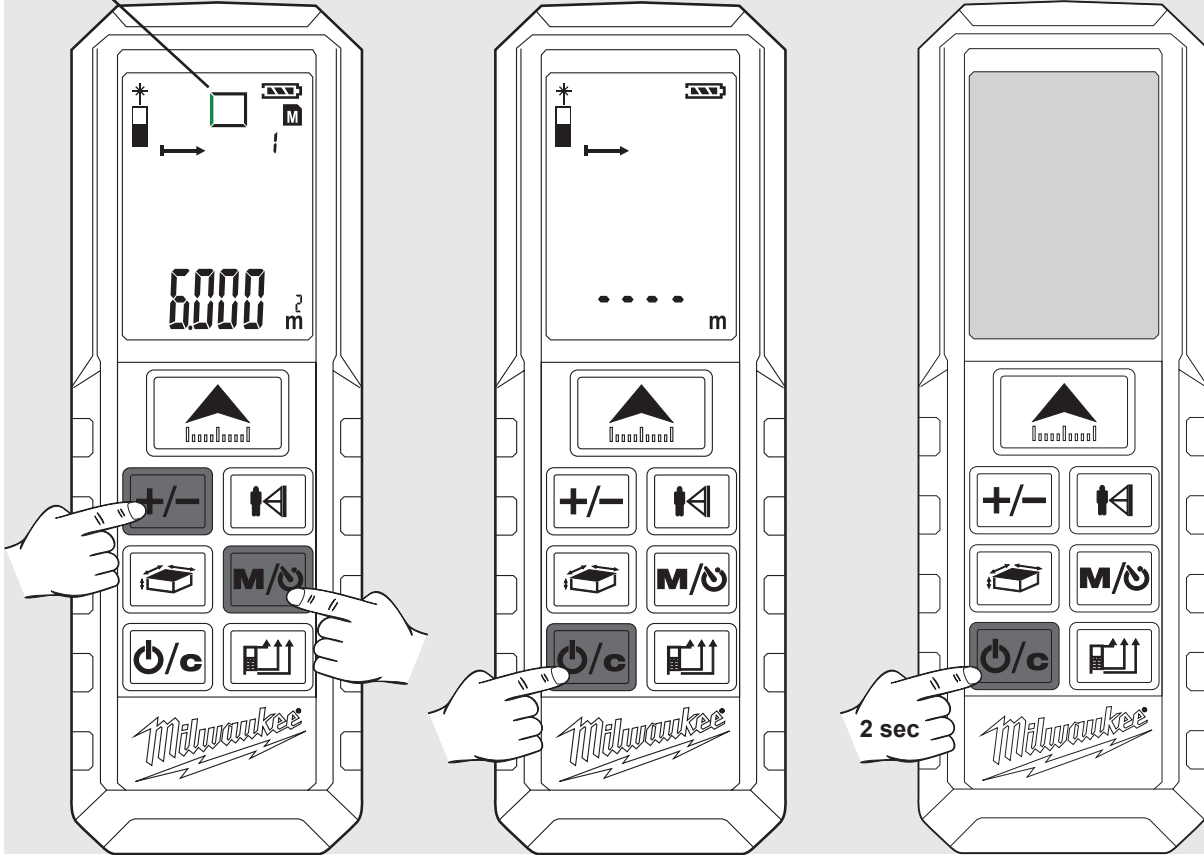

OBSAH

Důležité bezpečnostní pokyny.....	1
Technická data	2
Oblast Využití	2
Tabulka chybových kódů	2
Přehled	3
Výměna baterií	4
Rohový kolík.....	4
Držák na opasek.....	4
Funkční tlačítko, Funkce Pythagoras, Úroveň měření.....	5
Jednoduché měření délky	6
Kontinuální měření / měření minima - maxima.....	7
Měření připočítáním / měření odpočítáním.....	8
Měření plochy	9
Měření objemu.....	10
Nepřímé měření (funkce Pythagoras 1)	11
Nepřímé měření (funkce Pythagoras 2)	12
Nepřímé měření (funkce Pythagoras 3)	13
Měření plochy stěny (scénář 1)	14
Měření plochy stěny (scénář 2)	15
Časovač.....	16
Paměť.....	16
Základní způsob fungování na příkladu měření plochy (1)..	17
Základní způsob fungování na příkladu měřené plochy (2)..	18

DŮLEŽITÉ BEZPEČNOSTNÍ POKYNY



Než začnete výrobek používat, prostudujte si bezpečnostní pokyny a návod k obsluze na přiloženém CD.

Klasifikace laseru

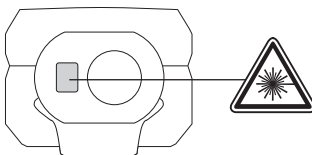

ÚPOZORNĚNÍ:

Jedná se o laserový výrobek **třídy 2** podle normy EN60825-1:2014.



λ 650 nm P<1 mW

Výstraha:

Vyhnete se přímému kontaktu s očima. Laserový paprsek může poškodit oči zábleskem a vést ke krátkodobému oslepení.

Nedívejte se přímo do laserového paprsku ani jej nesměřujte zbytečně na jiné osoby.

Neoslňujte jiné osoby.

Výstraha:

Laserový přístroj neprovozujte v blízkosti dětí a dětem nedovolte, aby laserový přístroj používaly.

Pozor! Reflexní povrch by mohl laserový paprsek odrazit zpět na obsluhu nebo jiné osoby.

Udržujte bezpečnou vzdálenost končetin od pohyblivých součástí.

Provádějte pravidelná zkušební měření. Zejména před důležitými měřeními, během nich a po nich.

Dávejte pozor na chybná měření, jestliže je výrobek vadný nebo pokud byl upuštěn či nesprávně používán nebo upravován.

Výstraha: Použití ovládacích prvků, nastavení nebo zrealizování jiných postupů než bylo stanoveno v příručce může vést k nebezpečnému ozáření.

Laserový měřicí přístroj má omezenou oblast použití. (Viz odstavec "Technické údaje"). Pokusy měřit mimo maximální a minimální rozsah způsobí nepřesnosti. Použití přístroje za nepříznivých podmínek, jako je příliš vysoká a příliš nízká teplota, velmi ostré sluneční světlo, déšť, sníh, mlha nebo jiné podmínky omezující viditelnost, může vést k nepřesným měřením.

Pokud bude přístroj přenesený z teplého prostředí do studeného prostředí (nebo naopak), musíte počkat, až se přístroj přizpůsobí nové teplotě okolního prostředí.

Laserový měřicí přístroj vždy uskladňujte v místnosti, přístroj chraňte před otřesy, vibracemi a extrémními teplotami.

Laserový měřicí přístroj chraňte před prachem, mokrým prostředím a vysokou vzdušnou vlhkostí. Tyto vlivy mohou zničit vnitřní součástky nebo ovlivnit přesnost měření.

Nepoužívejte žádné agresivní čisticí prostředky nebo rozpouštědla. Čistěte jen čistým měkkým hadříkem.

Vyhnete se silným úderům do přístroje nebo pádu laserového měřicího přístroje. Přesnost přístroje by se měla zkontrolovat tehdy, jestliže přístroj spadl nebo byl vystaven jinému mechanickému zatížení.

Potřebné opravy na tomto laserovém přístroji smí realizovat jen autorizovaný odborný personál.

Nepoužívejte výrobek v prostorách s nebezpečím výbuchu nebo v agresivním prostředí.

K nabíjení baterií používejte pouze nabíječky doporučené výrobcem.



Odpadní baterie a odpadní elektrická a elektronická zařízení se nesmějí likvidovat společně s domovním odpadem. Odpadní baterie a odpadní elektrická a elektronická zařízení je nutné sbírat a likvidovat odděleně.

Před likvidací odstraňte ze zařízení odpadní baterie, odpadní akumulátory a osvětlovací prostředky.

Informujte se na místních úřadech nebo u vašeho odborného prodejce ohledně recyklačních dvorů a sběrných míst.

Podle místních ustanovení mohou maloobchodní prodejci být povinni bezplatně odebrat zpět odpadní baterie a odpadní elektrická a elektronická zařízení.

Opětovným použitím a recyklací vašich odpadních baterií a vašich odpadních elektrických a elektronických zařízení přispíváte ke snížení potřeby surovin.

Odpadní baterie (především lithium-iontové baterie), odpadní elektrická a elektronická zařízení obsahují cenné, opětovně použitelné materiály, které při ekologické likvidaci nemohou mít negativní účinky na životní prostředí a vaše zdraví.

Před likvidací pokud možno vymažte na vašem odpadním přístroji existující osobní údaje.



Značka shody v Evropě



Britská značka shody



Značka shody na Ukrajině



Značka shody pro oblast Eurasie

TECHNICKÁ DATA

Třída ochrany	IP54 (chráněný proti prachu a stříkající vodě)
Optika	14 mm
Ohnisko	35 mm
Max. měřený rozsah	50 metrů (tolerance: 55 m)
Min. měřený rozsah	0,05 metru
Absolutní přesnost @ < 10m	± 1,5 mm (Max)
Opakovaná přesnost @ < 10m	± 1,5 mm (typicky max. 2σ)
Opakovaná přesnost @ > 10m	vzestup ± 0,25 mm / metr (typicky max. 2σ)
Doba měření	0,5 s
Typ displeje	LCD (22,7 mm x 31 mm)
Napájení	AAA 2x (alkalické baterie)
Životnost baterií	10000 (jednotlivých měření)
Výstupní výkon laseru	0,6 mW ~ 0,95 mW (třída 2, 650 nm)
Velikost laserového bodu	25 x 30 mm @ 16 m (Max)
Třída laseru	2
Typ laseru	650 nm, < 1 mW
Laserový paprsek vertikální úhel	+1 stupeň
Laserový paprsek horizontální úhel	±1 stupeň
Automatické vypnutí přístroje	180 sekund
Automatické vypnutí laseru	30 sekund
Rozsah provozní teploty	-10°C do +50°C
Rozsah teploty na uskladnění přístroje	-25°C do +70°C
Hmotnost bez baterií	80 g

OBLAST VYUŽITÍ

Laserový měřicí přístroj je vhodný na měření vzdáleností a sklonů.
Toto zařízení lze používat jen pro uvedený účel.

TABULKA CHYBOVÝCH KÓDŮ

Kód	Popis	Řešení
Err01	Mimo měřený rozsah	Měření proveďte ve stanoveném rozsahu.
Err02	Odražený signál je příliš slabý	Vyberte si lepší povrch.
Err03	Mimo interval zobrazování (max. hodnota: 99.999) např. když je výsledek plochy nebo objemu mimo interval zobrazování	Zkontrolujte, jestli jsou hodnoty a kroky správně.
Err04	Chyba ve výpočtu podle Pythagorovy věty	Zkontrolujte, jestli jsou hodnoty a kroky správně.
Err05	Slabé baterie	Vložte nové baterie.
Err06	Mimo rozsah provozní teploty	Měření zrealizujte ve stanoveném rozsahu provozní teploty.
Err07	Příliš jasné světlo okolního prostředí	Cílovou zónu zatemněte.

Funkce Pythagoras
převýšení

úroveň měření

měření délky

minimum / maximum pro kontinuální měření

sčítání / odčítání

ZAP / MĚŘIT

- ▶ Zap
- ▶ Měřit
- ▶ Kontinuální měření (stisknout 2 sek)
Min. / Max. funkce

SČÍTÁNÍ / ODČÍTÁNÍ

- ▶ Sčítat hodnotu
- ▶ Navigovat v paměti

PLOCHA / OBJEM

- ▶ Plocha (stisknout 1x)
- ▶ Objem (stisknout 2x)
- ▶ Nepřímé měření plochy (stisknout 3x / 4x)

ZAPNUTÍ

- ▶ Zap
- ▶ Vyp (stisknout 2 sek)
- ▶ Vrátit do původního stavu

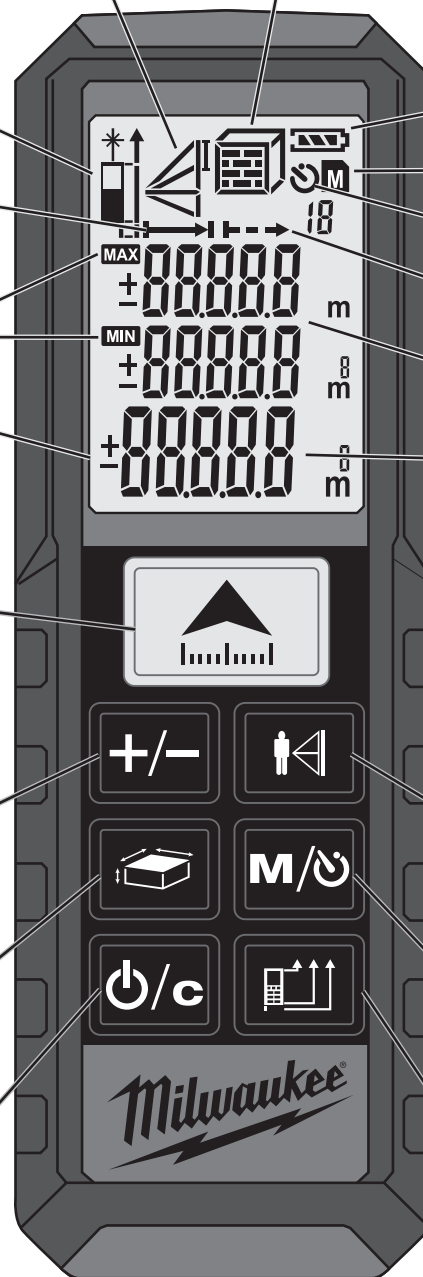

plocha / objem
nepřímé měření plochy

stav baterií

paměť

časovač

kontinuální měření

mezihodnoty

celková hodnota

FUNKCE PYTHAGORAS

- ▶ Funkce Pythagoras 1 (stisknout 1x)
- ▶ Funkce Pythagoras 2 (stisknout 2x)
- ▶ Funkce Pythagoras 3 (stisknout 3x)

PAMĚŤ

- ▶ Časovač 3-15 sek (stisknout 1x)
- ▶ Paměť 1-20 (stisknout 1x 2 sek)
- ▶ Vyvolat si hodnoty z paměti (opětovně stisknout)

ZMĚNA ÚROVNĚ MĚŘENÍ

- ▶ od přední části
- ▶ od zadní části
- ▶ od rohového kolíku

VÝMĚNA BATERIÍ

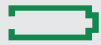
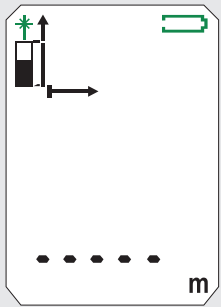

Když bliká symbol,
je třeba vyměnit
baterie.

1

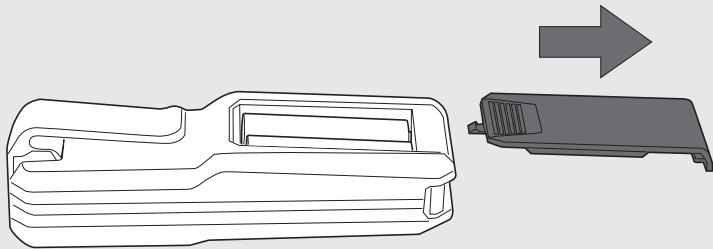

2

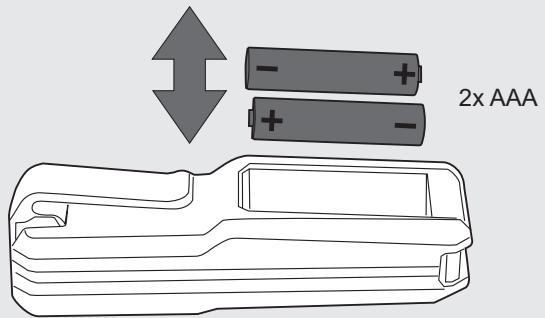

3

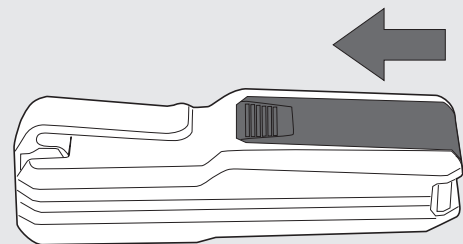

ROHOVÝ KOLÍK

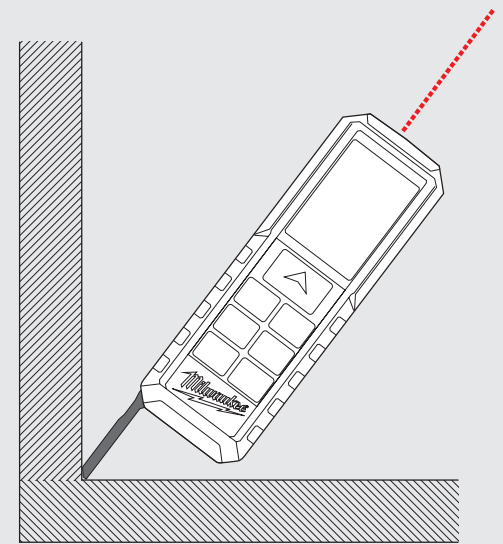
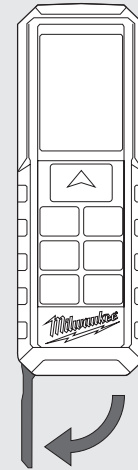

DRŽÁK NA OPASEK

1

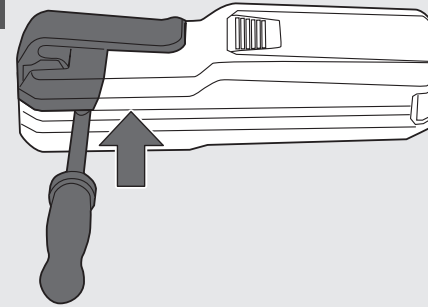

2

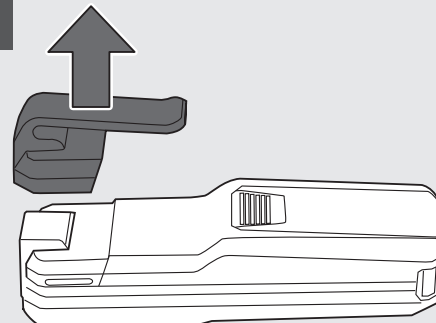

3

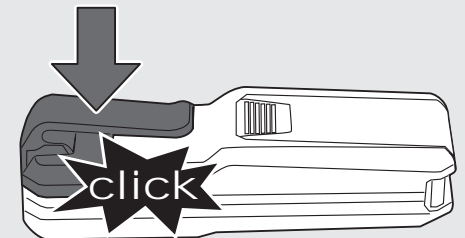

FUNKČNÍ TLAČÍTKO, FUNKCE PYTHAGORAS, ÚROVEŇ MĚŘENÍ

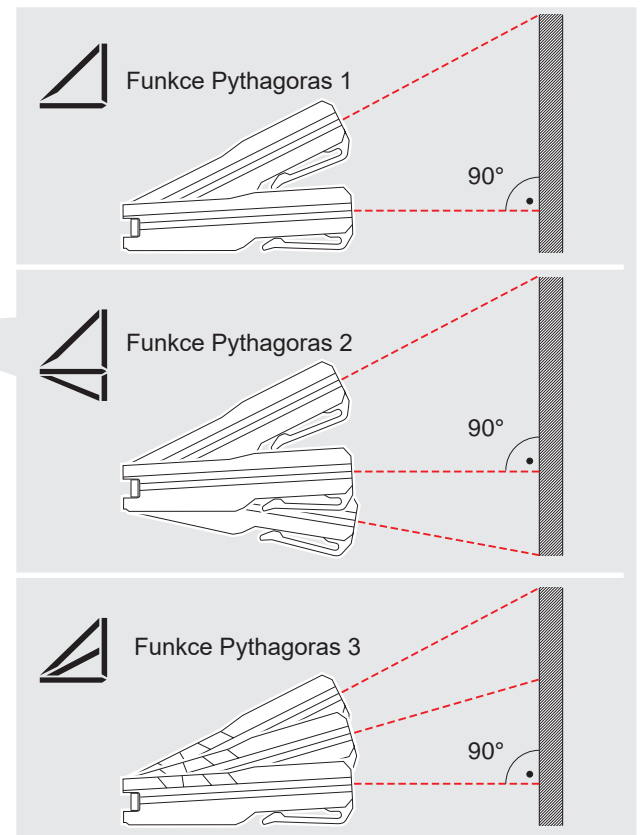
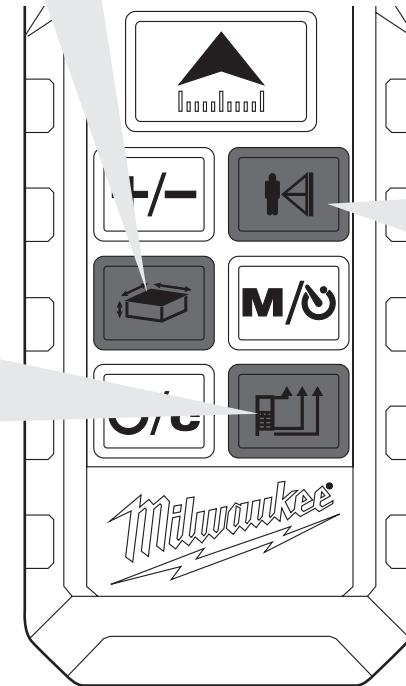
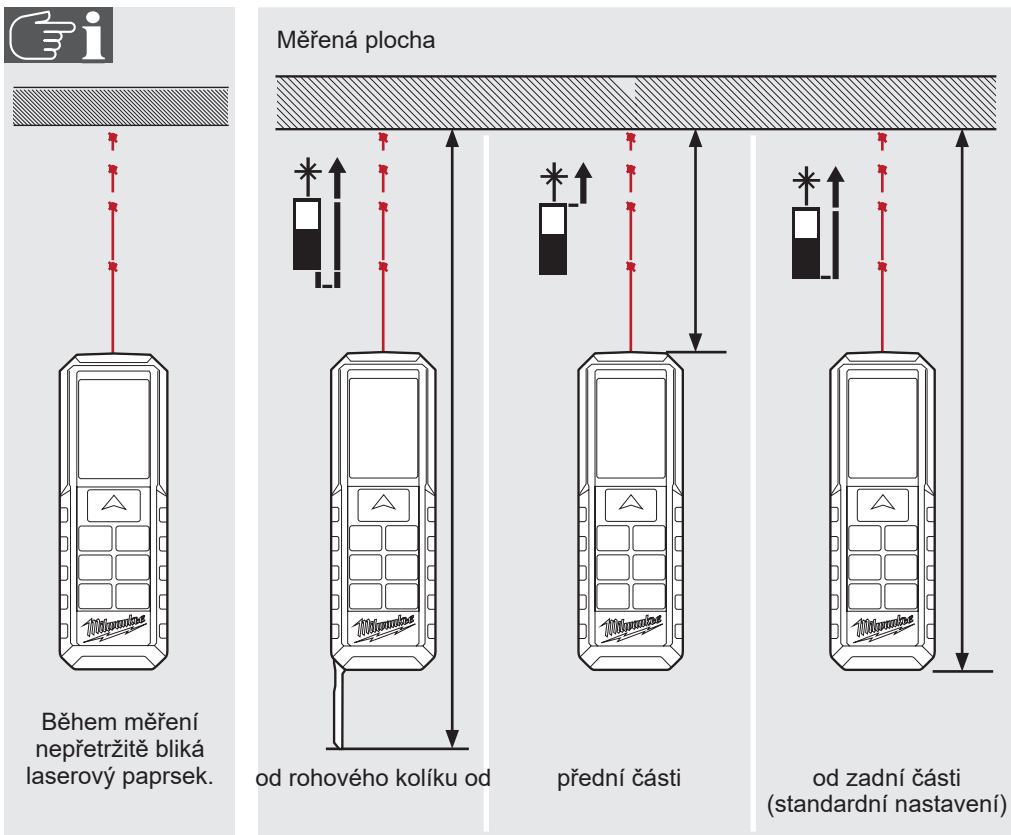
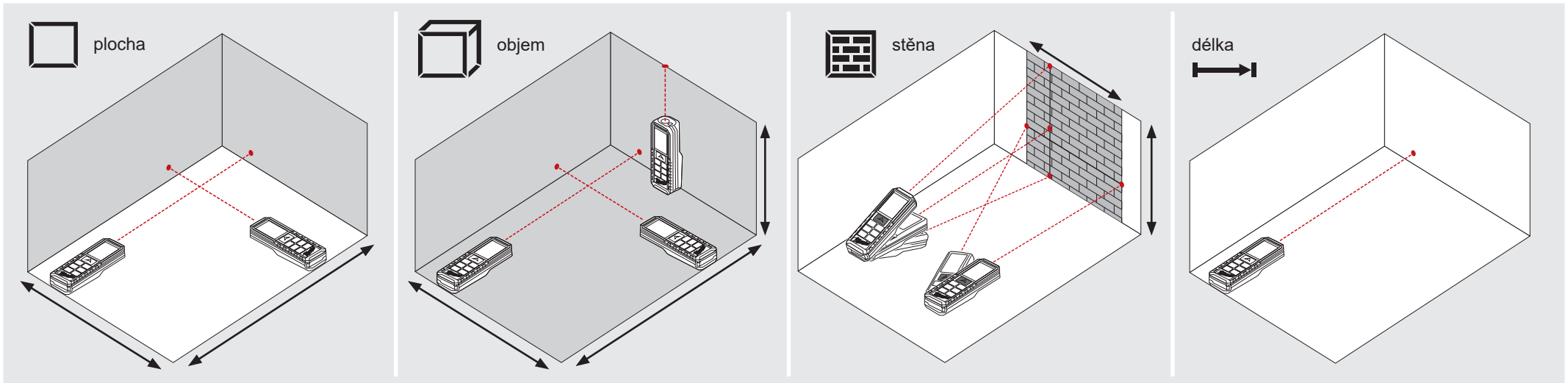

JEDNODUCHÉ MĚŘENÍ DÉLKY

0	1	2	3	4

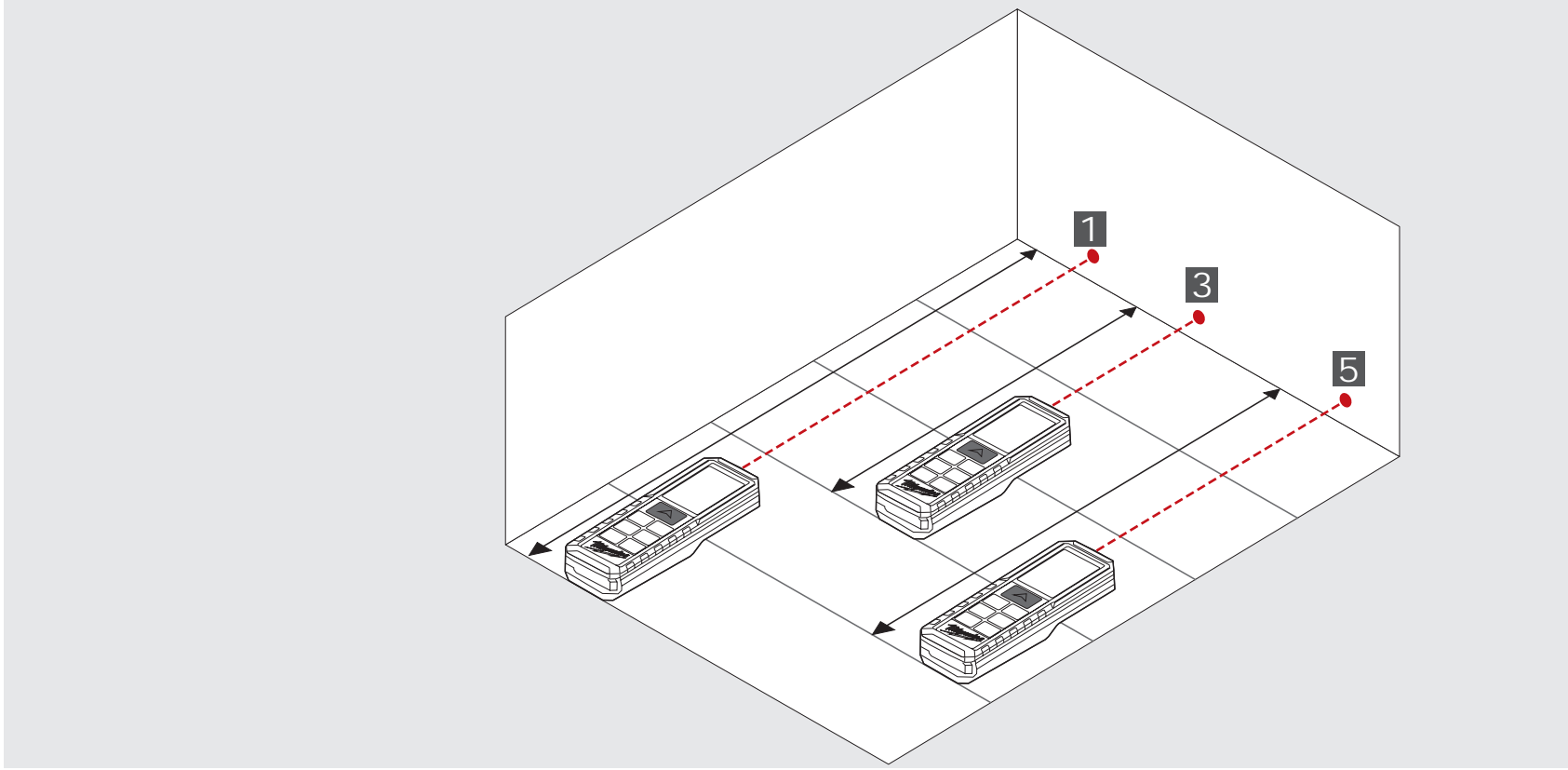

5

KONTINUALNÍ MĚŘENÍ / MĚŘENÍ MINIMA - MAXIMA

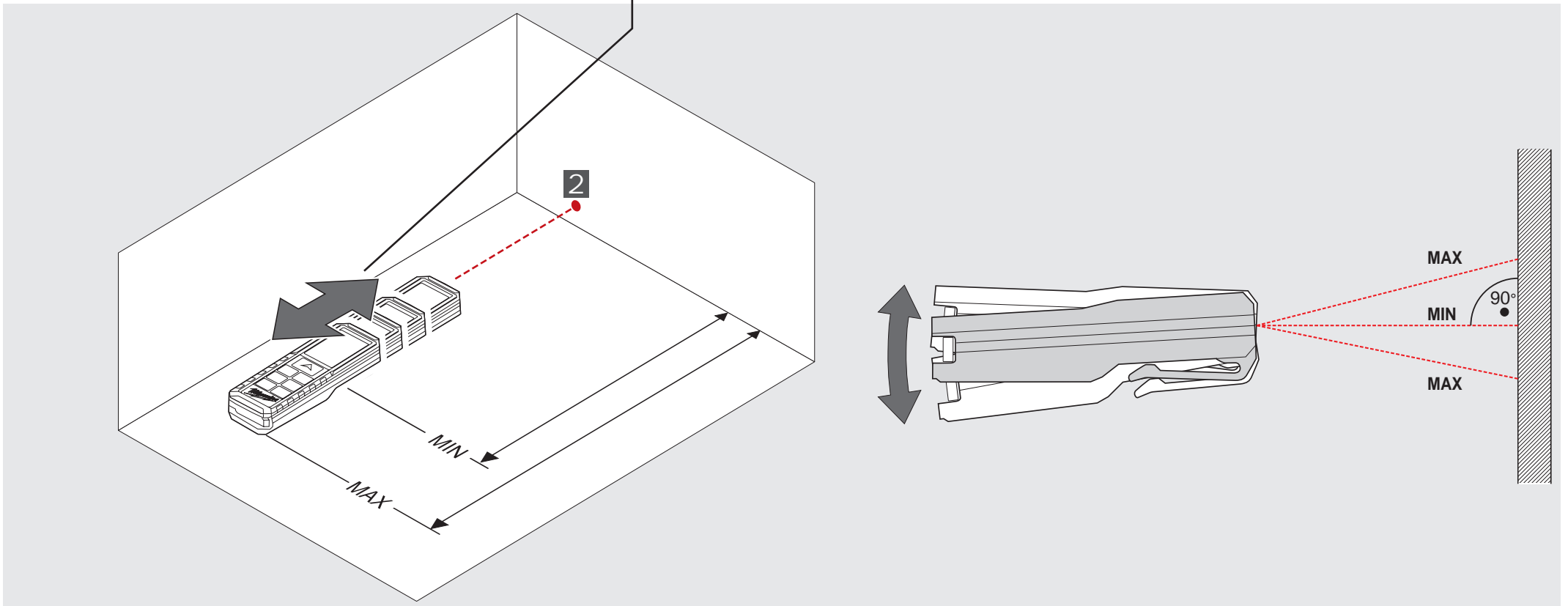
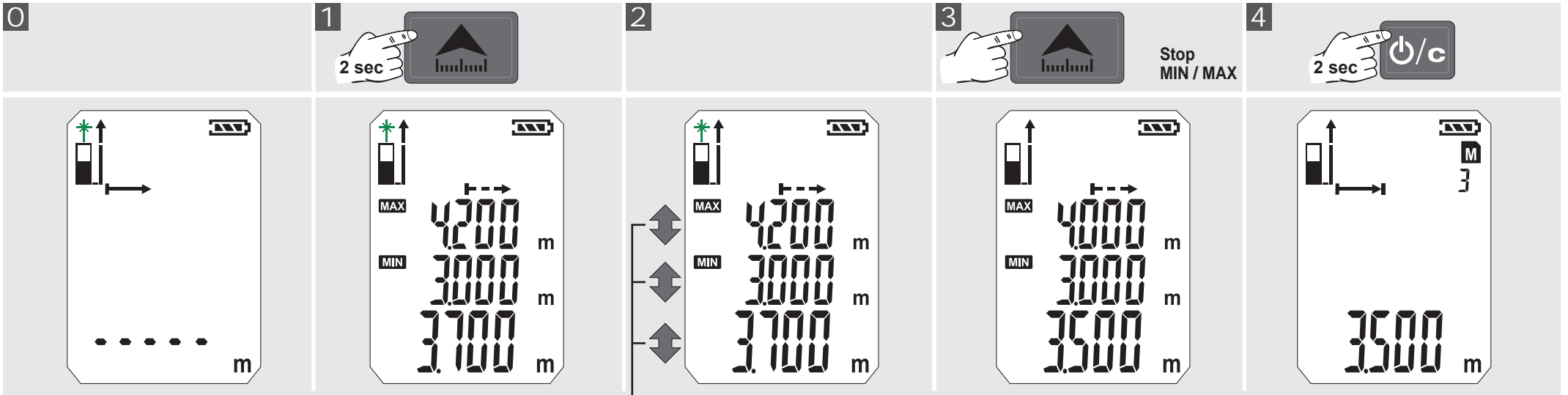

0

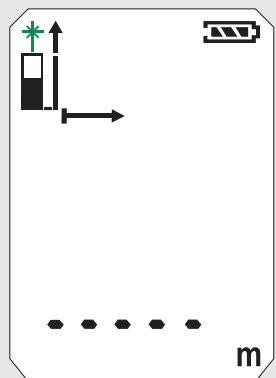

1

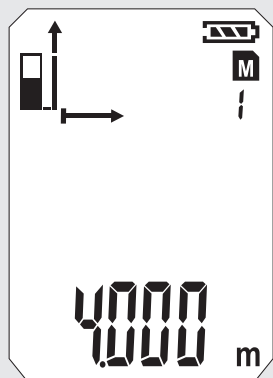

2

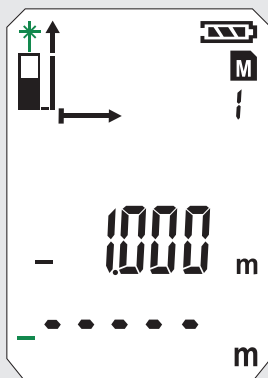

3

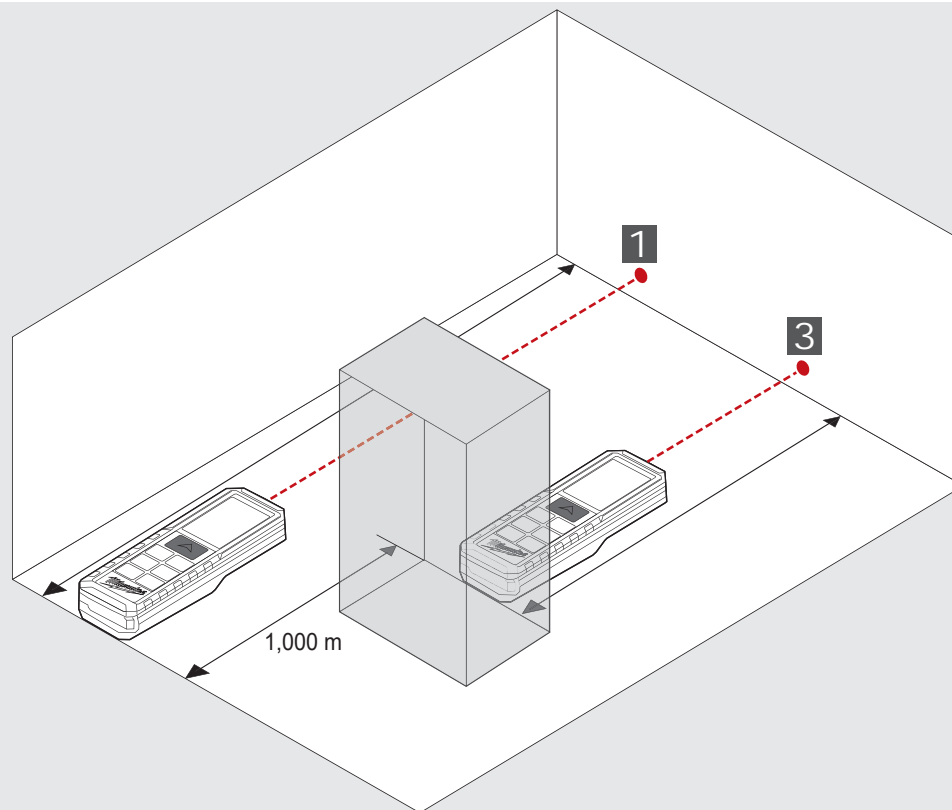
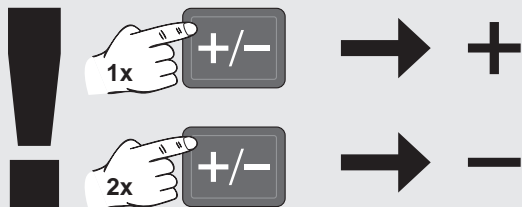
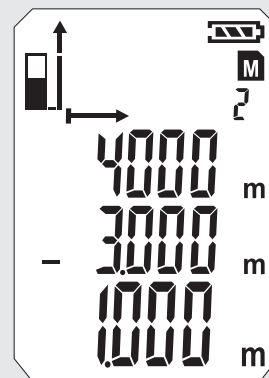

0



1



2

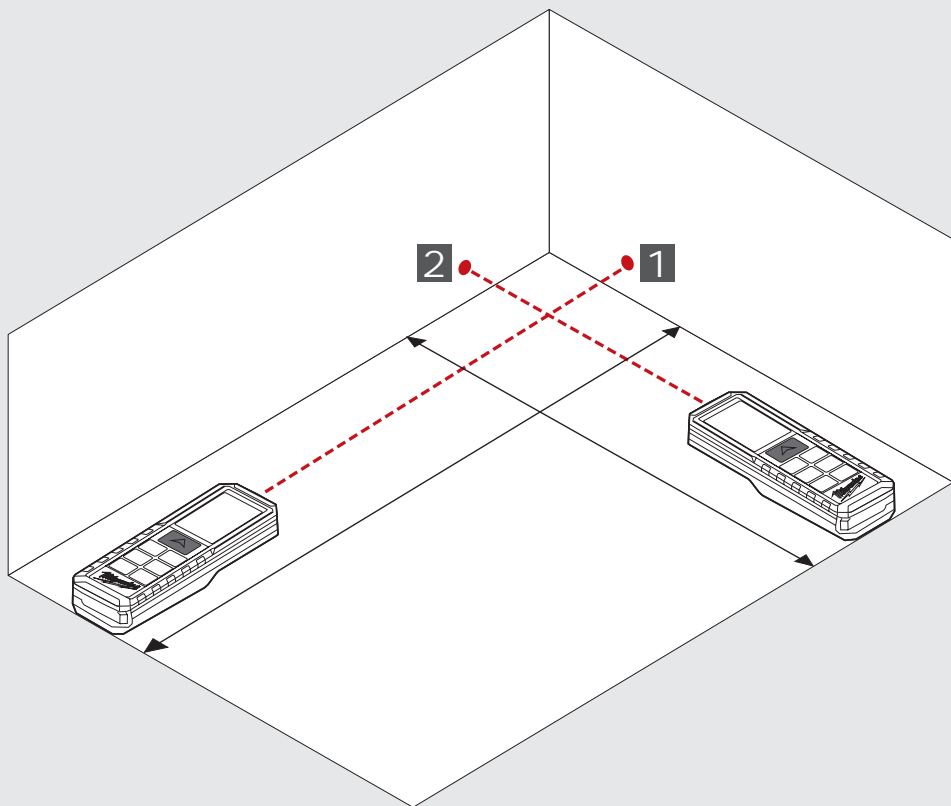
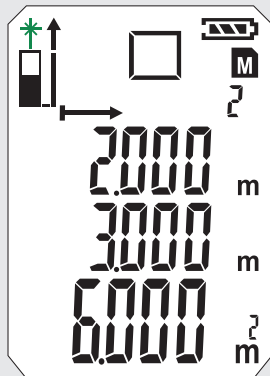
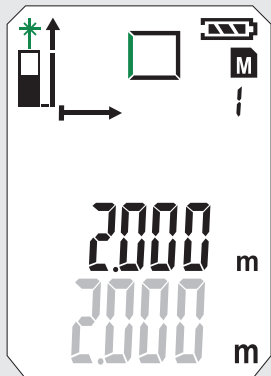
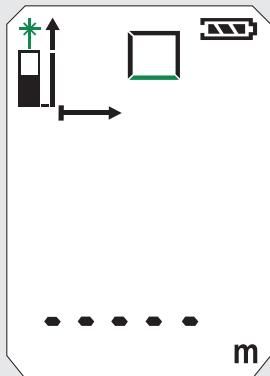

MĚŘENÍ OBJEMU

0



1



2



3

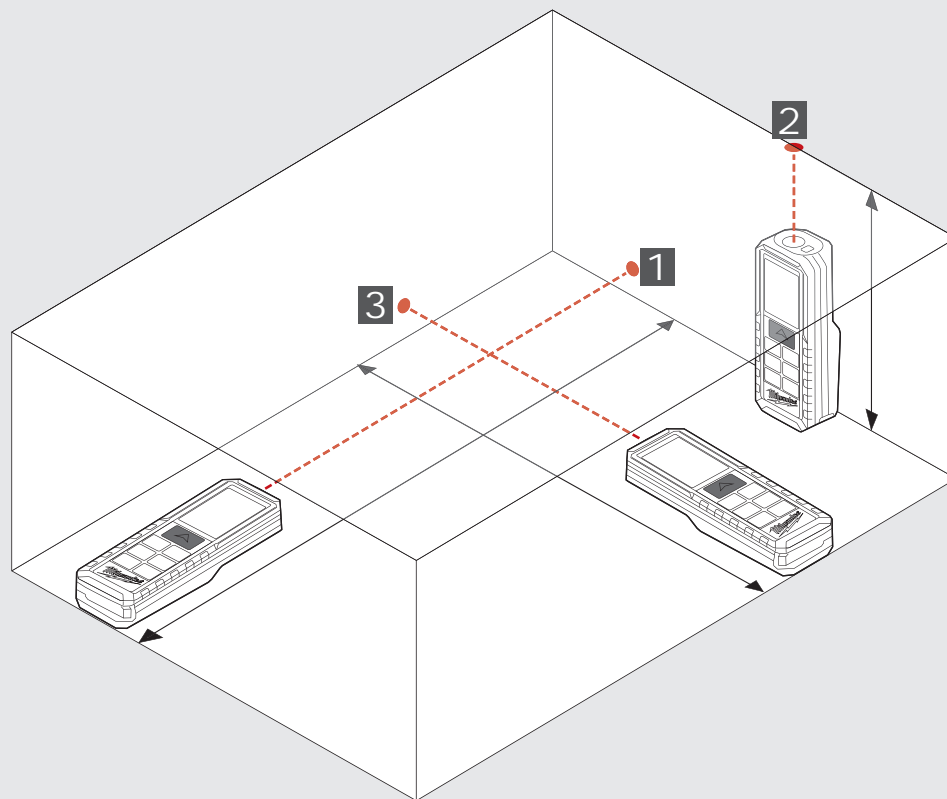
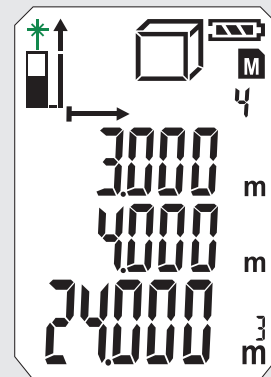
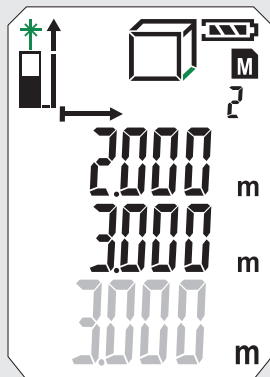
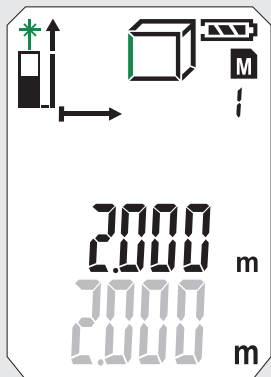
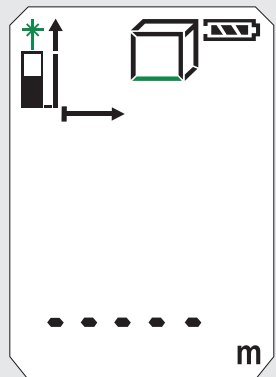

NEPRÍMÉ MĚŘENÍ (FUNKCE PYTHAGORAS 1)

0







1

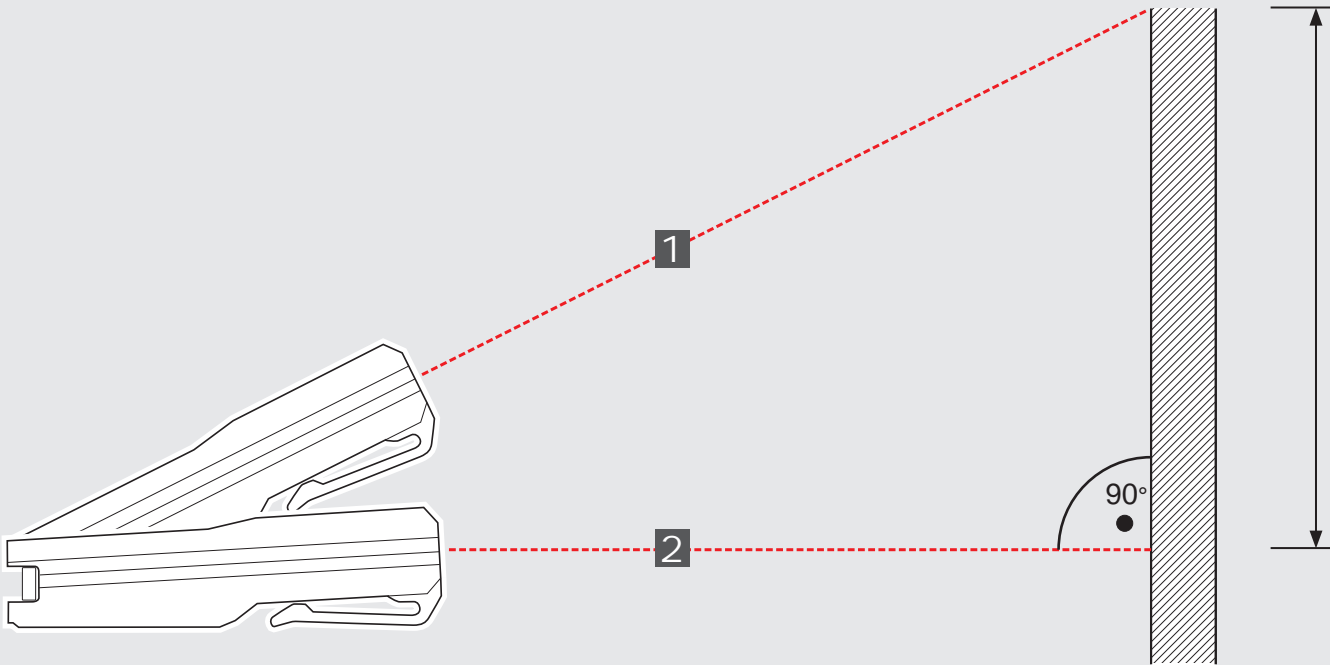
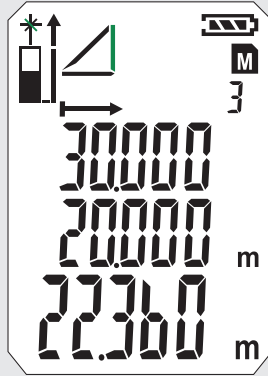
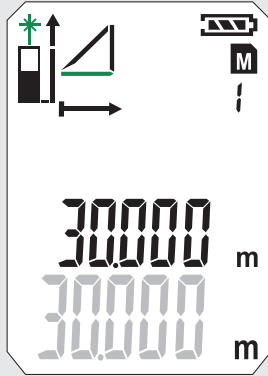
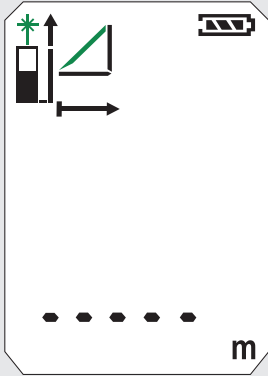

2

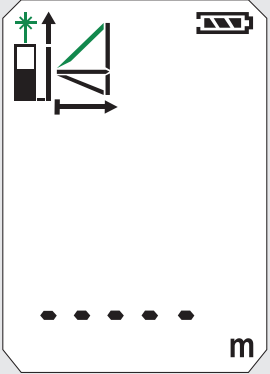
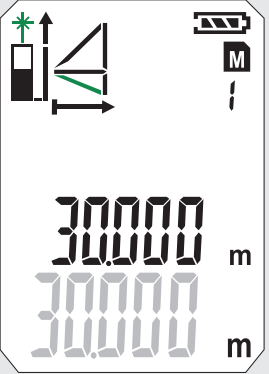
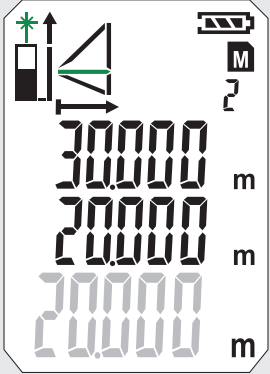
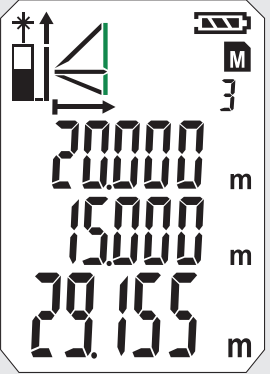

NEPRÍMÉ MĚŘENÍ (FUNKCE PYTHAGORAS 2)

<p>0</p>  <p>2 x</p>	<p>1</p> 	<p>2</p> 	<p>3</p> 
			

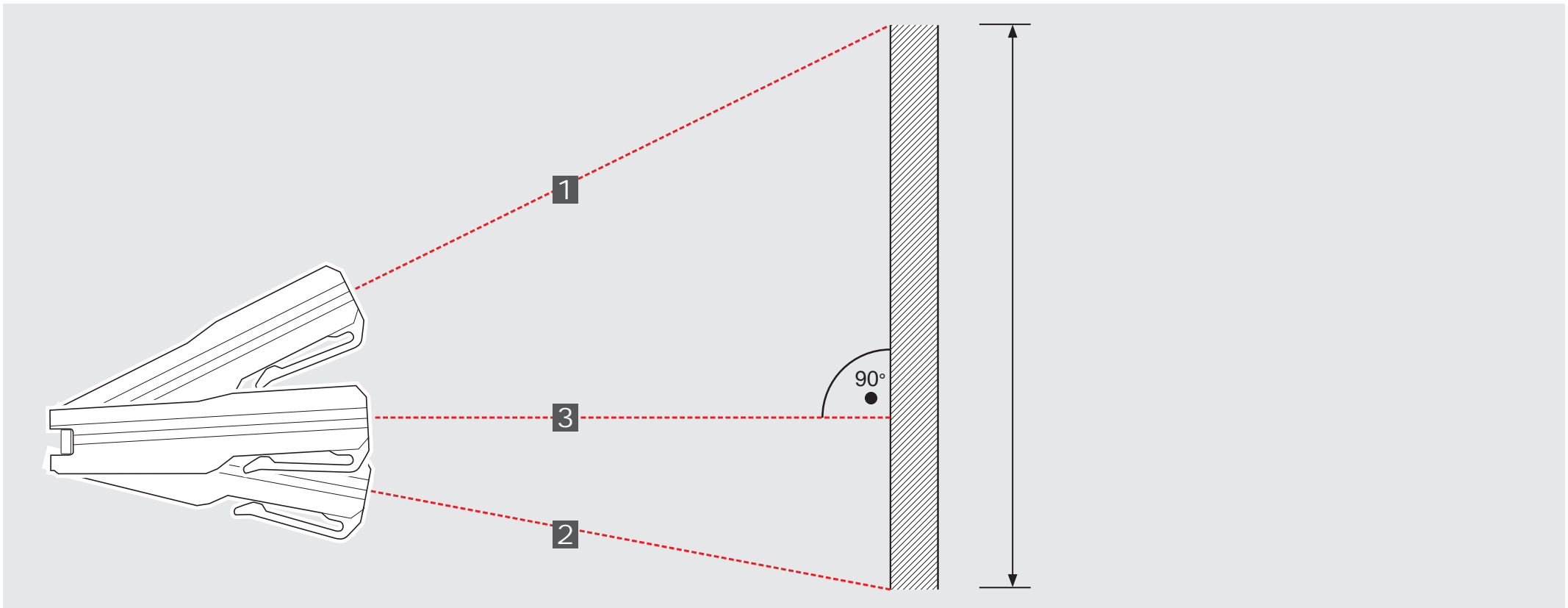

NEPRÍMÉ MĚŘENÍ (FUNKCE PYTHAGORAS 3)

1



2







3

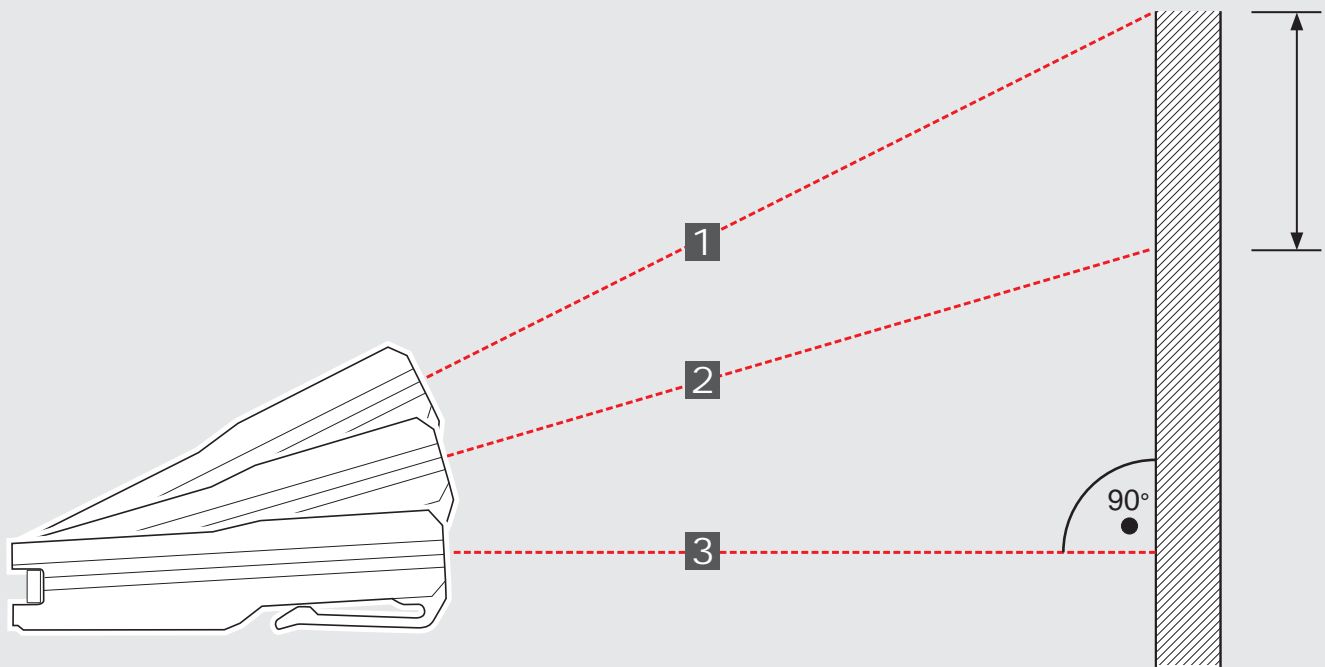
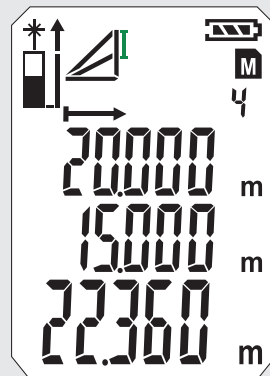
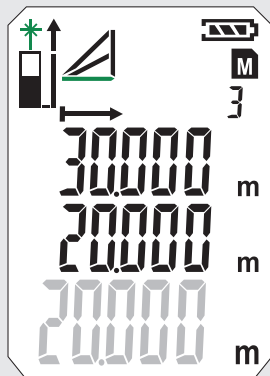
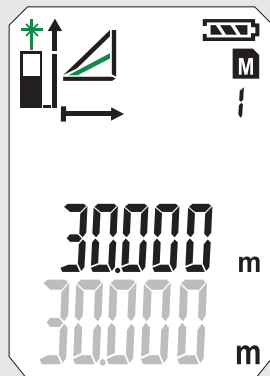
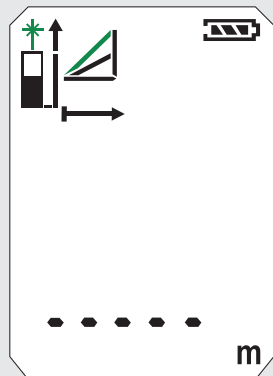

4

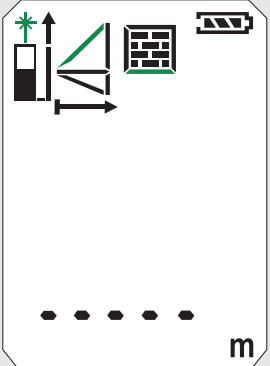
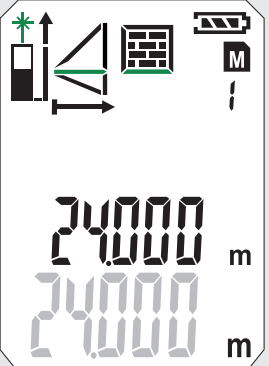
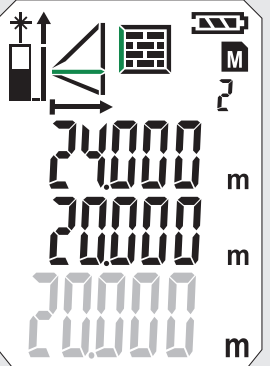
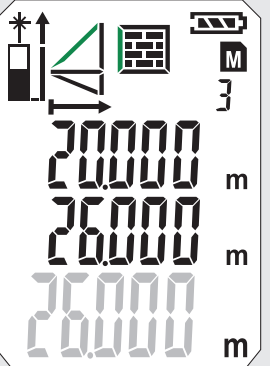
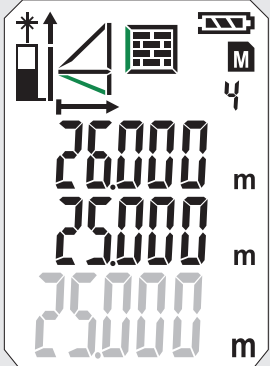

MĚŘENÍ PLOCHY STĚNY (SCÉNÁŘ 1)

<p>0</p> 	<p>1</p> 	<p>2</p> 	<p>3</p> 	<p>4</p> 
				

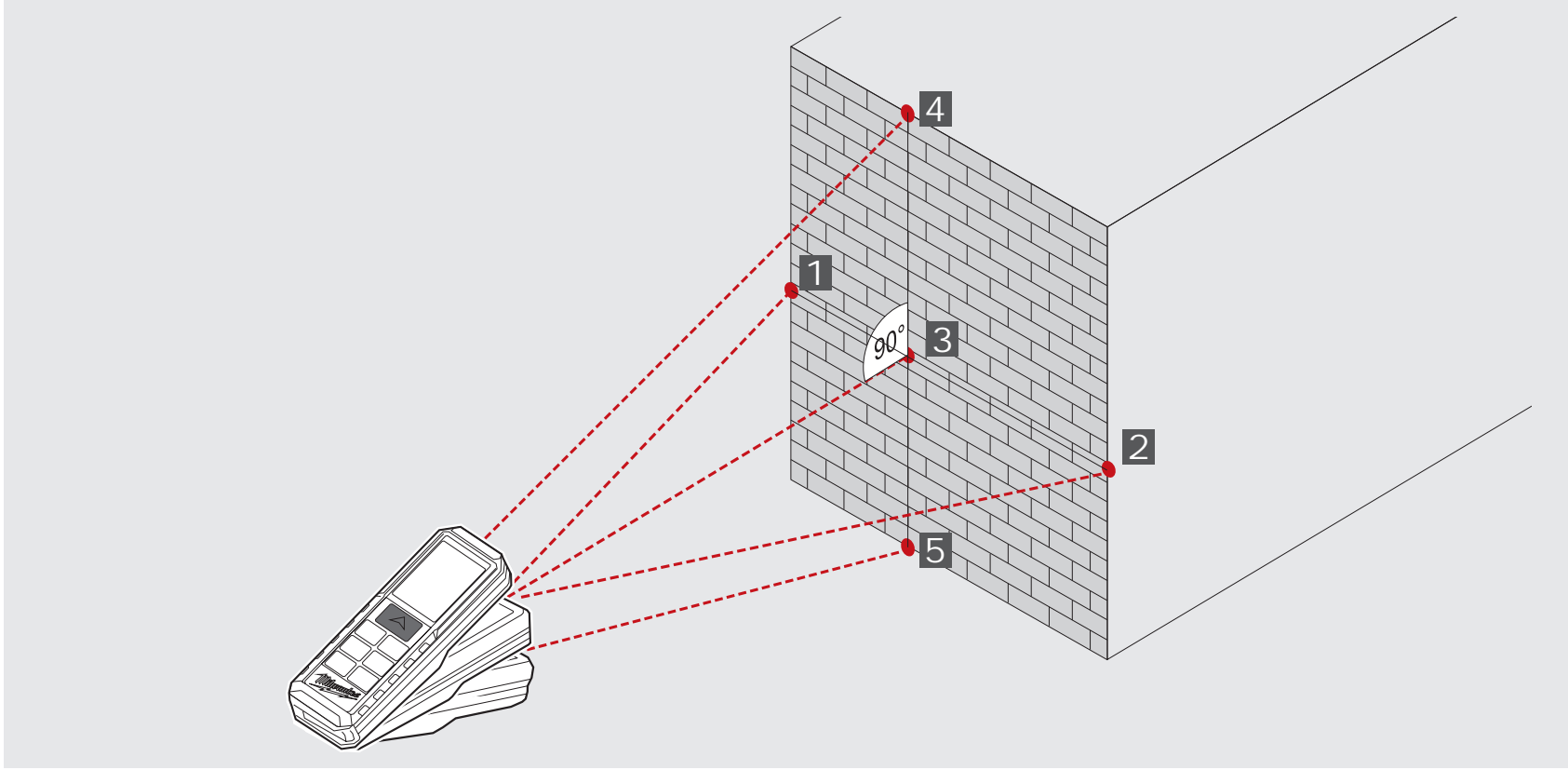



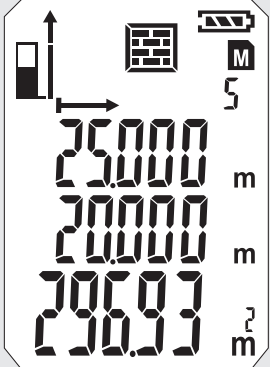

5



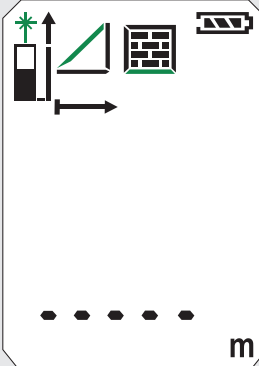
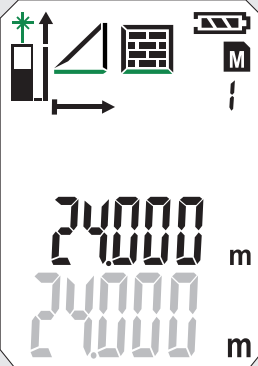
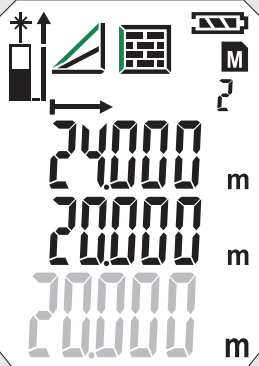
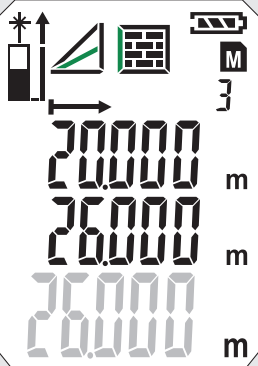
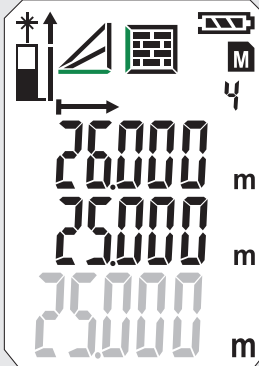

MĚŘENÍ PLOCHY STĚNY (SCÉNÁŘ 2)

<p>0</p> 	<p>1</p> 	<p>2</p> 	<p>3</p> 	<p>4</p> 
				

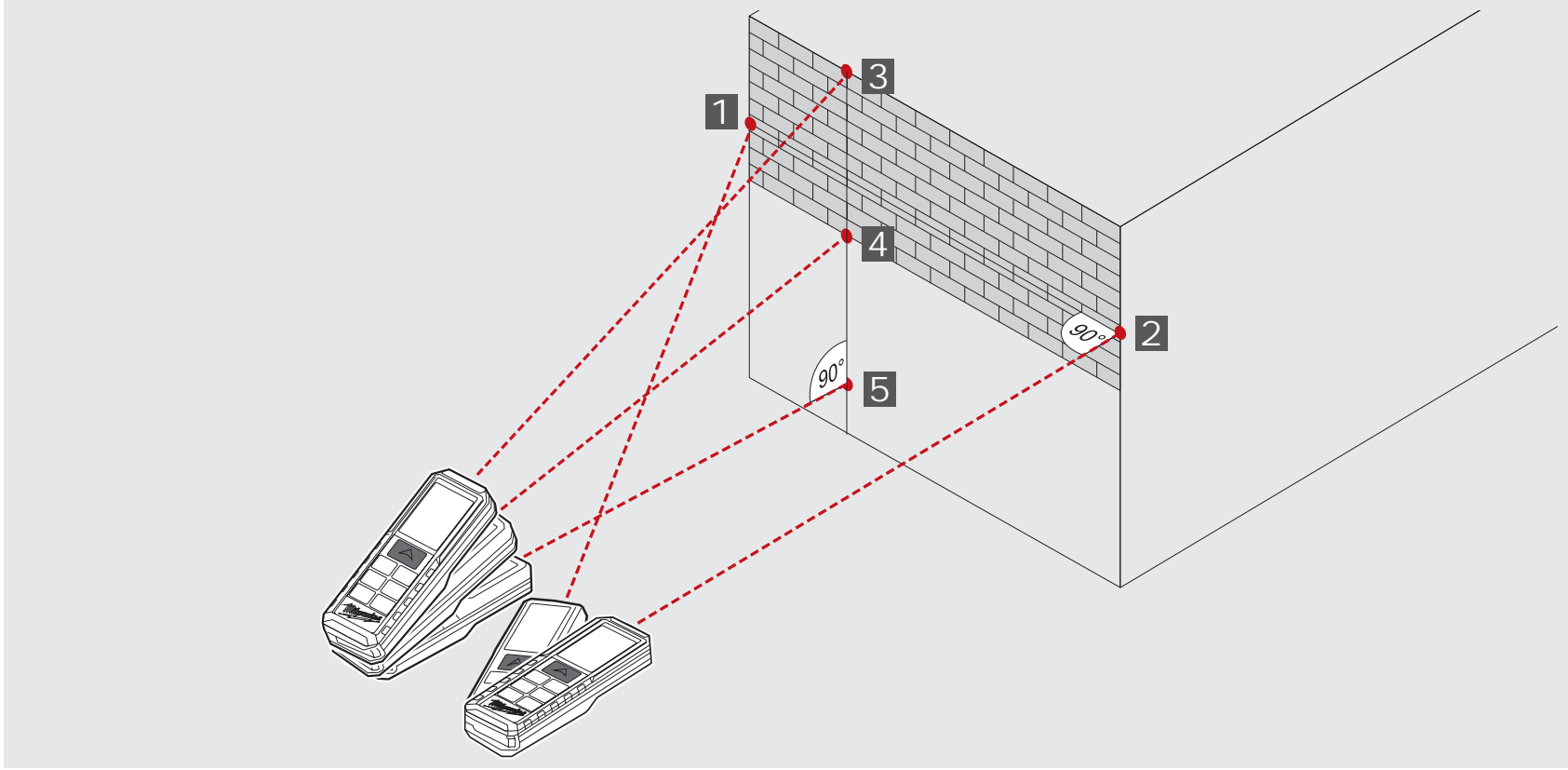

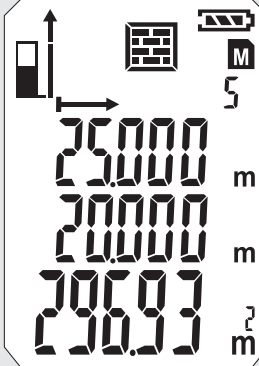

5





CASOVAC

Pomocí časovače se dá měření spustit s pozdějším startem, aby se např. na konstrukční díl mohl umístit měřený paprsek.

Stiskněte tlačítko 

- Objeví se symbol
- Stisknutím tlačítka  se časovač dá nastavit v rozpětí od 3 do 15 sekund.

Stiskněte tlačítko 

- Sekundy se budou odpočítávat do měření.
- Při 0 se spustí měření.

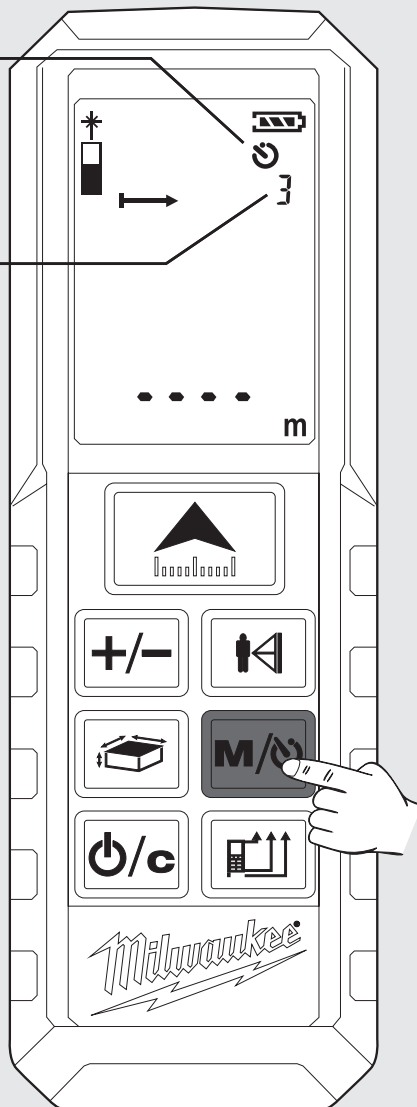

PAMĚŤ

Naměřené hodnoty se automaticky průběžně ukládají do paměti.

Hodnoty uložené v paměti je možné vyvolat tlačítkem  .

Stiskněte tlačítko  na 2 sekundy

- Objeví se symbol a místo v paměti.
- Zobrazí se příslušná měřená veličina.
- V paměti uložená hodnota se zobrazí v hlavním řádku.
- Hodnoty uložené v paměti si vyvolejte opětovným stisknutím tlačítka  .

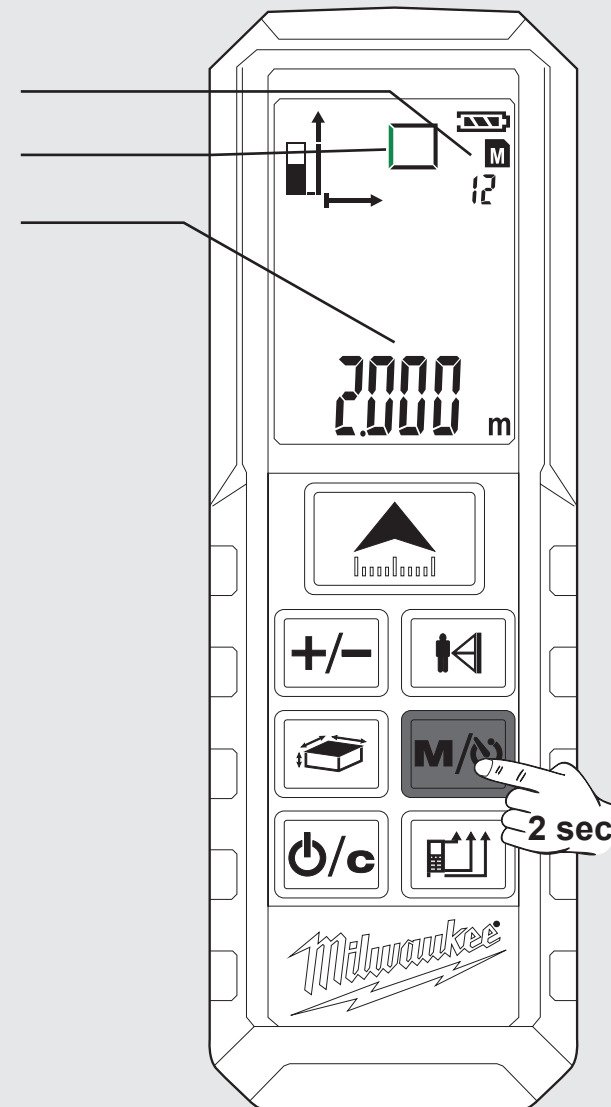

ZÁKLADNÍ ZPŮSOB FUNGOVÁNÍ NA PŘÍKLADU MĚŘENÍ PLOCHY (1)

1 Zapnutí

Stiskněte tlačítko 
⚠ Pozor! Laserový paprsek je zapnutý!
 Nemířte jím na osoby!

2 Výběr úrovně měření

Po zapnutí standardní nastavení: měření od zadní části měřiče
 stisknout 1x -> od rohového kolíku
 stisknout 2x -> měření od přední části měřiče
 stisknout 3x -> měření od zadní části měřiče

3 Výběr funkce

Po zapnutí je přístroj vždy nastavený na měření délky.
 stisknout 1x - měření plochy

4 Měření délky

Přístroj vyrovnejte a stiskněte tlačítko 

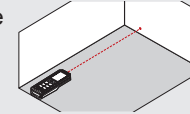

5 Měření šířky

Přístroj vyrovnejte a stiskněte tlačítko 

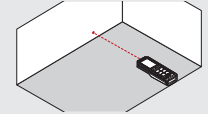

Bliká symbol laseru (blikání zobrazené zelenou barvou).

Zobrazí se symbol

- Objeví se symbol
 - Bliká měřená hodnota (blikání zobrazené zelenou barvou)

- Naměřená hodnota se krátce zobrazí v hlavním řádku.
 - Naměřená hodnota po 1 sekundě přeskočí do řádku ležícího výše.
 - Naměřená hodnota se uloží do paměti pod pořadovým číslem.
 - Bliká druhá měřená hodnota. Přístroj je připravený na měření druhé hodnoty.

- Naměřená hodnota se krátce zobrazí v hlavním řádku.
 - Naměřená hodnota po 1 sekundě přeskočí do řádku ležícího výše.
 - Naměřená hodnota se uloží do paměti pod pořadovým číslem.
 - Výsledek se zobrazí v hlavním řádku a uloží se do paměti pod pořadovým číslem.

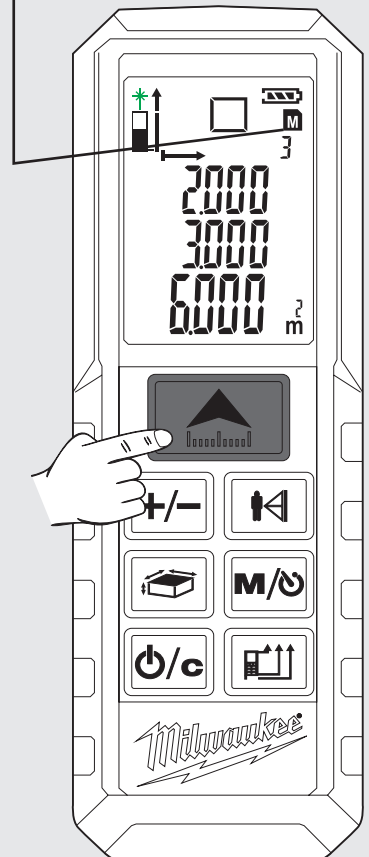
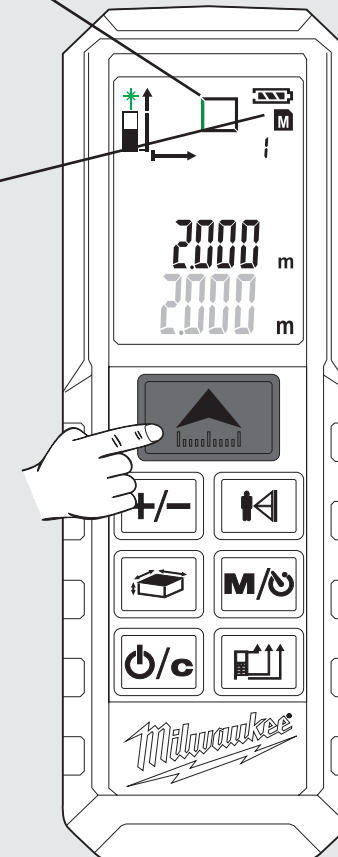
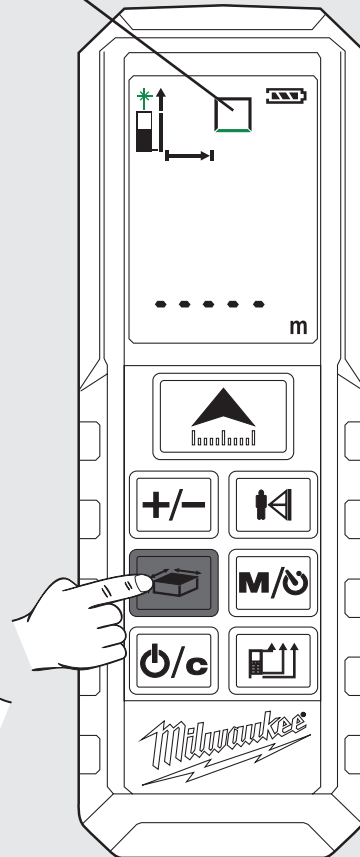
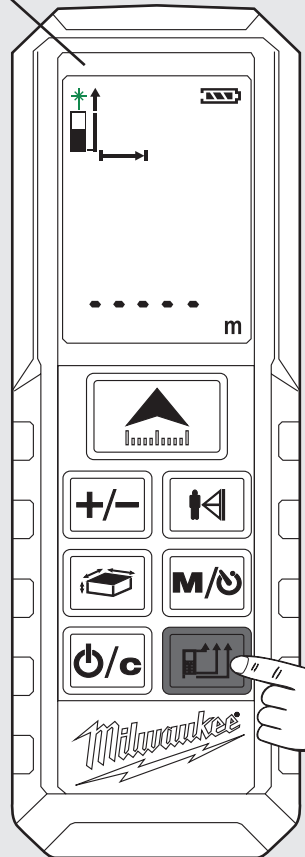
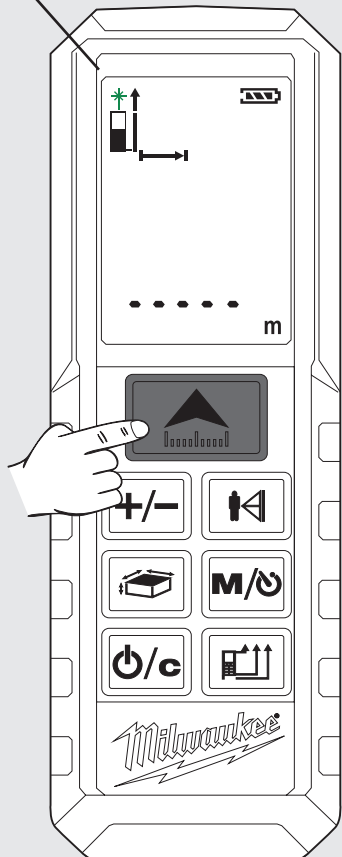

ZÁKLADNÍ ZPŮSOB FUNGOVÁNÍ NA PŘÍKLADU MĚŘENÉ PLOCHY (2)

6 Vvolání hodnot uložených v paměti

Tlačítko **M/0** stiskněte na 2 sekundy.
Opětovně stiskněte tlačítko **M/0**.

7 Opuštění paměti

Stiskněte tlačítko **0/c**

8 Vypnutí

Tlačítko **0/c** stiskněte na 2 sekundy.
(Předtím se musí odejít z paměti).

- Hodnoty uložené v paměti se zobrazí v hlavním řádku.

- Zobrazí se příslušný symbol a bliká měřená hodnota (blikání zobrazené zelenou barvou).

- Přístroj se vypne.

- Pokud se v průběhu 3 minut nestiskne žádné tlačítko, přístroj se vypne automaticky.

